

**Cool MOS™ Power Transistor**



**Feature**

- New revolutionary high voltage technology
- Worldwide best  $R_{DS(on)}$  in TO 220
- Ultra low gate charge
- Periodic avalanche rated
- Extreme  $dv/dt$  rated
- Ultra low effective capacitances
- Improved noise immunity

**Product Summary**

$V_{DS}$	800	V
$R_{DS(on)}$	290	m $\Omega$
$I_D$	17	A

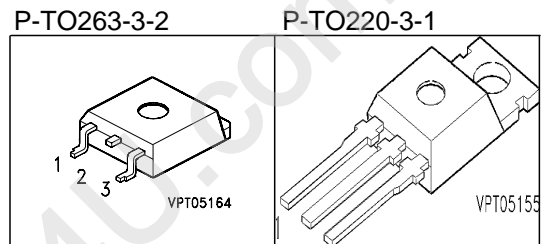

Type	Package	Ordering Code	Marking
SPP17N80C2	P-TO220-3-1	Q67040-S4353	SPP17N80C2
SPB17N80C2	P-TO263-3-2	Q67040-S4354	SPB17N80C2

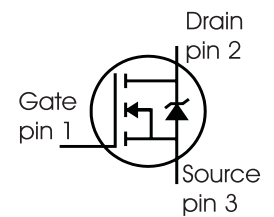

**Maximum Ratings**, at  $T_j = 25\text{ °C}$ , unless otherwise specified

Parameter	Symbol	Value	Unit
Continuous drain current	$I_D$	17	A
$T_C = 25\text{ °C}$		17	
$T_C = 100\text{ °C}$		11	
Pulsed drain current, $t_p$ limited by $T_{jmax}$	$I_{D\text{ puls}}$	51	
Avalanche energy, single pulse	$E_{AS}$	670	mJ
$I_D=4A, V_{DD}=50V$			
Avalanche energy, repetitive $t_{AR}$ limited by $T_{jmax}$ <sup>1)</sup>	$E_{AR}$	0.5	
$I_D=17A, V_{DD}=50V$			
Avalanche current, repetitive $t_{AR}$ limited by $T_{jmax}$	$I_{AR}$	17	A
Reverse diode $dv/dt$	$dv/dt$	6	V/ns
$I_S=17A, V_{DS} < V_{DD}, di/dt=100A/\mu s, T_{jmax}=150\text{ °C}$			
Gate source voltage	$V_{GS}$	$\pm 20$	V
Power dissipation	$P_{tot}$	208	W
$T_C = 25\text{ °C}$			
Operating and storage temperature	$T_j, T_{stg}$	-55... +150	$\text{°C}$

**Thermal Characteristics**

Parameter	Symbol	Values			Unit
		min.	typ.	max.	
<b>Characteristics</b>					
Thermal resistance, junction - case	$R_{thJC}$	-	-	0.6	K/W
Thermal resistance, junction - ambient, leaded	$R_{thJA}$	-	-	62	
SMD version, device on PCB: @ min. footprint @ 6 cm <sup>2</sup> cooling area <sup>2)</sup>	$R_{thJA}$	-	-	62	
		-	35	-	
Linear derating factor		-	-	1.67	W/K
Soldering temperature, 1.6 mm (0.063 in.) from case for 10s	$T_{sold}$	-	-	260	°C

**Electrical Characteristics, at  $T_j = 25\text{ °C}$ , unless otherwise specified**
**Static Characteristics**

Drain-source breakdown voltage $V_{GS}=0V, I_D=0.25mA$	$V_{(BR)DSS}$	800	-	-	V
Drain-source avalanche breakdown voltage $V_{GS}=0V, I_D=17A$	$V_{(BR)DS}$	-	870	-	
Gate threshold voltage, $V_{GS} = V_{DS}$ $I_D=1mA$	$V_{GS(th)}$	2	3	4	
Zero gate voltage drain current $V_{DS} = 800\text{ V}, V_{GS} = 0\text{ V}, T_j = 25\text{ °C}$ $V_{DS} = 800\text{ V}, V_{GS} = 0\text{ V}, T_j = 150\text{ °C}$	$I_{DSS}$	-	0.5	25	μA
		-	-	250	
Gate-source leakage current $V_{GS}=20V, V_{DS}=0V$	$I_{GSS}$	-	-	100	nA
Drain-source on-state resistance $V_{GS}=10V, I_D=11A, T_j=25\text{ °C}$	$R_{DS(on)}$	-	250	290	mΩ
Gate input resistance $f = 1\text{ MHz}$ , open drain	$R_G$	-	0.7	-	Ω

<sup>1</sup> Repetitive avalanche causes additional power losses that can be calculated as  $P_{AV} = E_{AR} * f$ .

<sup>2</sup> Device on 40mm\*40mm\*1.5mm epoxy PCB FR4 with 6cm<sup>2</sup> (one layer, 70 μm thick) copper area for drain connection. PCB is vertical without blown air.

**Preliminary data**
**SPP17N80C2  
SPB17N80C2**
**Electrical Characteristics** , at  $T_j = 25\text{ }^\circ\text{C}$ , unless otherwise specified

Parameter	Symbol	Conditions	Values			Unit
			min.	typ.	max.	
<b>Characteristics</b>						
Transconductance	$g_{fs}$	$V_{DS} \geq 2 \cdot I_D \cdot R_{DS(on)max}$ , $I_D = 11\text{A}$	-	15	-	S
Input capacitance	$C_{iss}$	$V_{GS} = 0\text{V}$ , $V_{DS} = 25\text{V}$ ,	-	2320	-	pF
Output capacitance	$C_{oss}$	$f = 1\text{MHz}$	-	1250	-	
Reverse transfer capacitance	$C_{rss}$		-	60	-	
Effective output capacitance, <sup>1)</sup> energy related	$C_{o(er)}$	$V_{GS} = 0\text{V}$ , $V_{DS} = 0\text{V to } 640\text{V}$	-	59	-	pF
Effective output capacitance, <sup>2)</sup> time related	$C_{o(tr)}$		-	124	-	
Turn-on delay time	$t_{d(on)}$	$V_{DD} = 400\text{V}$ , $V_{GS} = 0/10\text{V}$ ,	-	45	-	ns
Rise time	$t_r$	$I_D = 17\text{A}$ , $R_G = 5.6\Omega$ ,	-	17	-	
Turn-off delay time	$t_{d(off)}$	$T_j = 125^\circ\text{C}$	-	77	88	
Fall time	$t_f$		-	10	13	

**Gate Charge Characteristics**

Gate to source charge	$Q_{gs}$	$V_{DD} = 640\text{V}$ , $I_D = 17\text{A}$	-	9	-	nC
Gate to drain charge	$Q_{gd}$		-	42	-	
Gate charge total	$Q_g$	$V_{DD} = 640\text{V}$ , $I_D = 17\text{A}$ , $V_{GS} = 0\text{ to } 10\text{V}$	-	83	107	
Gate plateau voltage	$V_{(plateau)}$	$V_{DD} = 640\text{V}$ , $I_D = 17\text{A}$	-	6	-	V

<sup>1)</sup>  $C_{o(er)}$  is a fixed capacitance that gives the same stored energy as  $C_{oss}$  while  $V_{DS}$  is rising from 0 to 80%  $V_{DSS}$ .

<sup>2)</sup>  $C_{o(tr)}$  is a fixed capacitance that gives the same charging time as  $C_{oss}$  while  $V_{DS}$  is rising from 0 to 80%  $V_{DSS}$ .

**Electrical Characteristics**, at  $T_j = 25\text{ }^\circ\text{C}$ , unless otherwise specified

Parameter	Symbol	Conditions	Values			Unit
			min.	typ.	max.	
<b>Reverse Diode</b>						
Inverse diode continuous forward current	$I_S$	$T_C=25^\circ\text{C}$	-	-	17	A
Inverse diode direct current, pulsed	$I_{SM}$		-	-	51	
Inverse diode forward voltage	$V_{SD}$	$V_{GS}=0\text{V}, I_F=I_S$	-	1	1.2	V
Reverse recovery time	$t_{rr}$	$V_R=400\text{V}, I_F=I_S,$	-	550	-	ns
Reverse recovery charge	$Q_{rr}$	$di_F/dt=100\text{A}/\mu\text{s}$	-	13	-	$\mu\text{C}$
Peak reverse recovery current	$I_{rrm}$		-	40	-	A
Peak rate of fall of reverse recovery current	$di_{rr}/dt$		-	1200	-	$\text{A}/\mu\text{s}$

**Transient Thermal Characteristics**

Symbol	Value	Unit	Symbol	Value	Unit
	typ.			typ.	

**Transient thermal impedance**

Thermal resistance			Thermal capacitance		
$R_{th1}$	0.00716	K/W	$C_{th1}$	0.000441	Ws/K
$R_{th2}$	0.01		$C_{th2}$	0.0014	
$R_{th3}$	0.022		$C_{th3}$	0.000985	
$R_{th4}$	0.065		$C_{th4}$	0.0045	
$R_{th5}$	0.083		$C_{th5}$	0.02	
$R_{th6}$	0.038		$C_{th6}$	0.146	

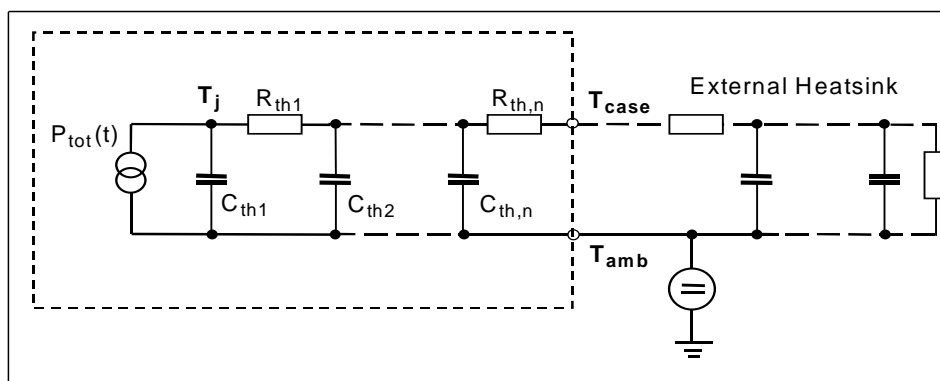

**1 Power dissipation**

$P_{tot} = f(T_C)$

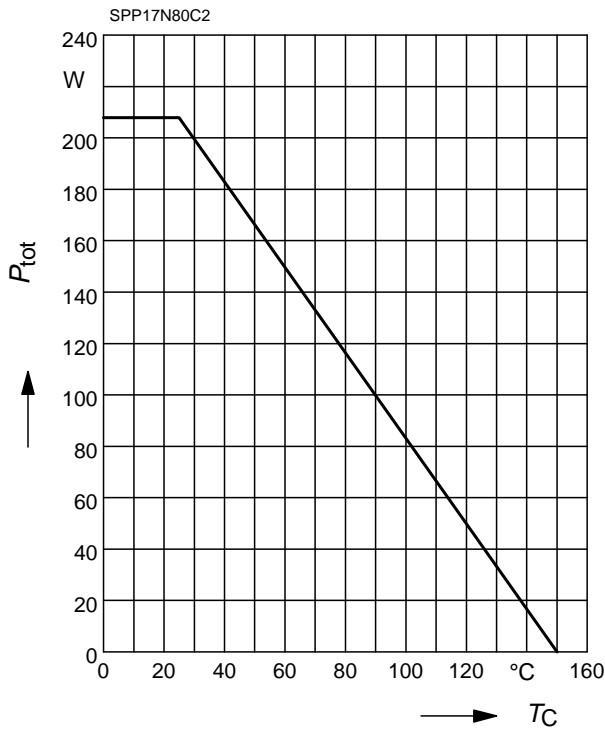

**2 Drain current**

$I_D = f(T_C)$

parameter:  $V_{GS} \geq 10\text{ V}$

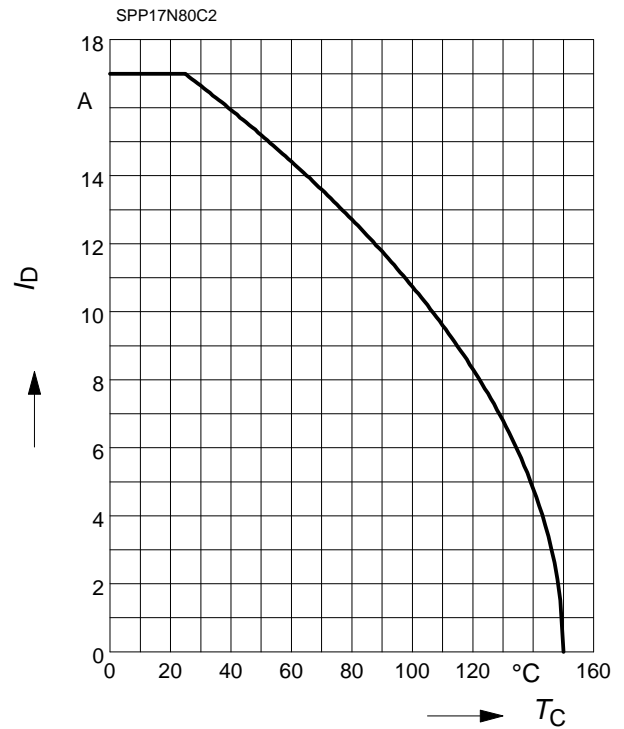

**3 Safe operating area**

$I_D = f(V_{DS})$

parameter:  $D = 0, T_C = 25^\circ\text{C}$

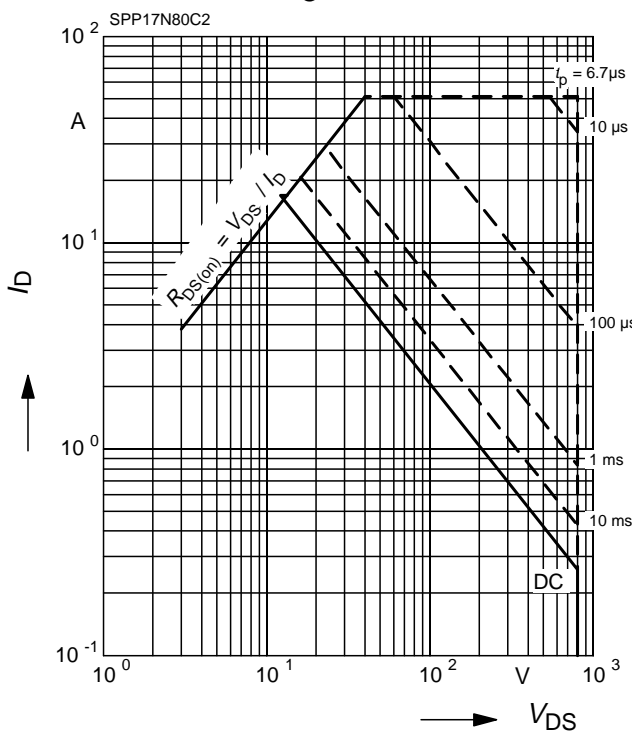

**4 Transient thermal impedance**

$Z_{thJC} = f(t_p)$

parameter:  $D = t_p/T$

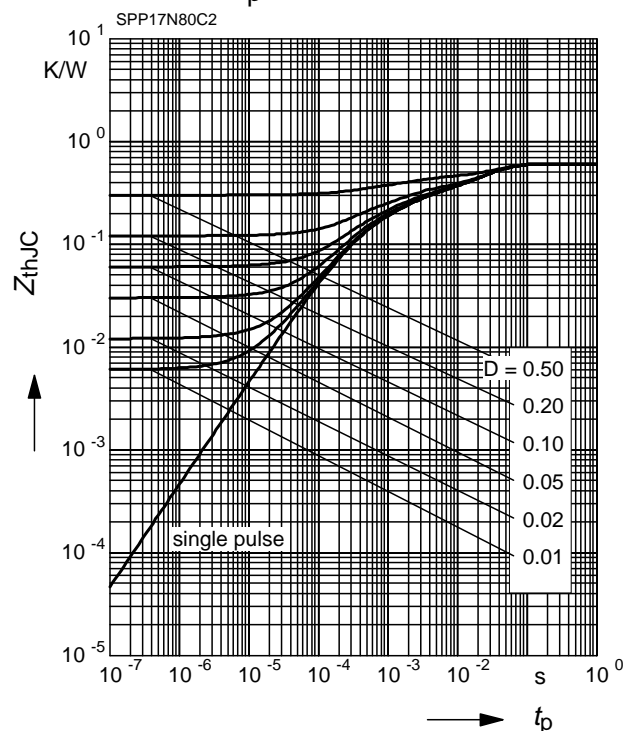

**5 Typ. output characteristic**

$I_D = f(V_{DS}); T_j = 25^\circ\text{C}$

parameter:  $t_p = 10 \mu\text{s}, V_{GS}$

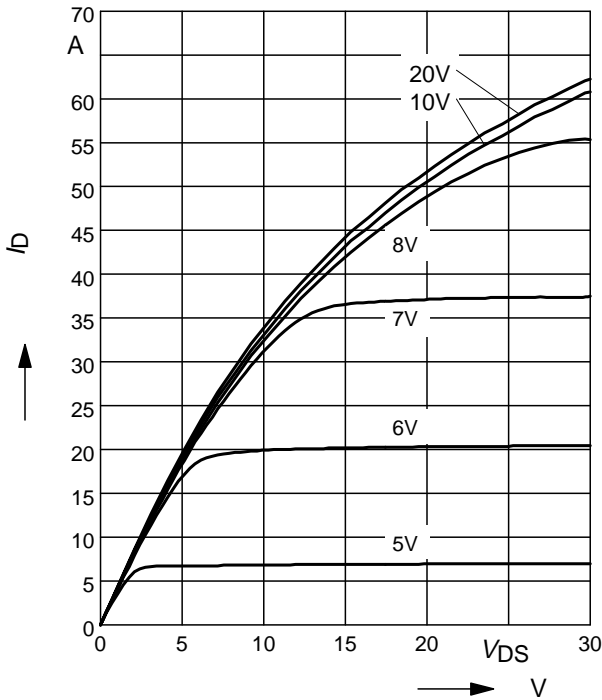

**6 Typ. output characteristic**

$I_D = f(V_{DS}); T_j = 150^\circ\text{C}$

parameter:  $t_p = 10 \mu\text{s}, V_{GS}$

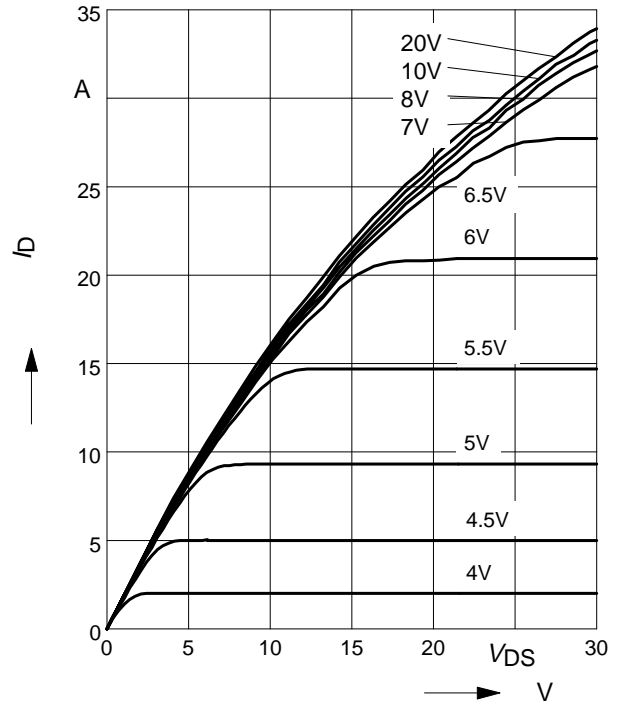

**7 Typ. drain-source on resistance**

$R_{DS(on)} = f(I_D)$

parameter:  $T_j = 150^\circ\text{C}, V_{GS}$

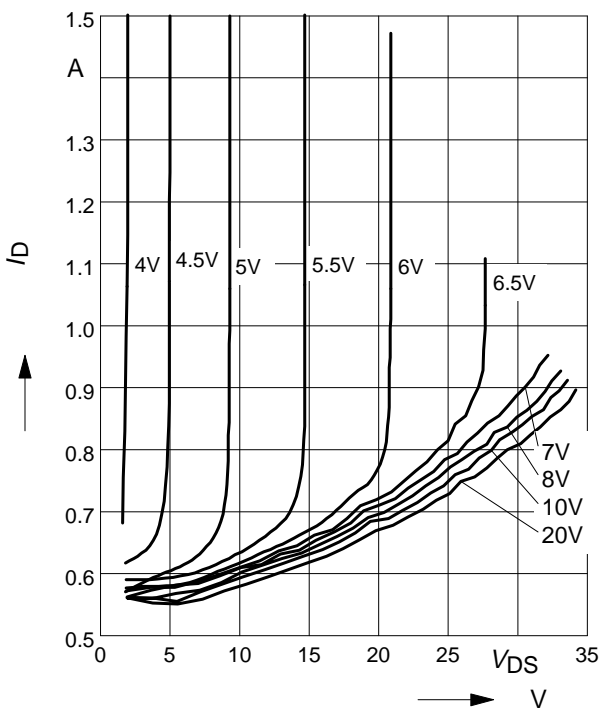

**8 Drain-source on-state resistance**

$R_{DS(on)} = f(T_j)$

parameter:  $I_D = 11 \text{ A}, V_{GS} = 10 \text{ V}$

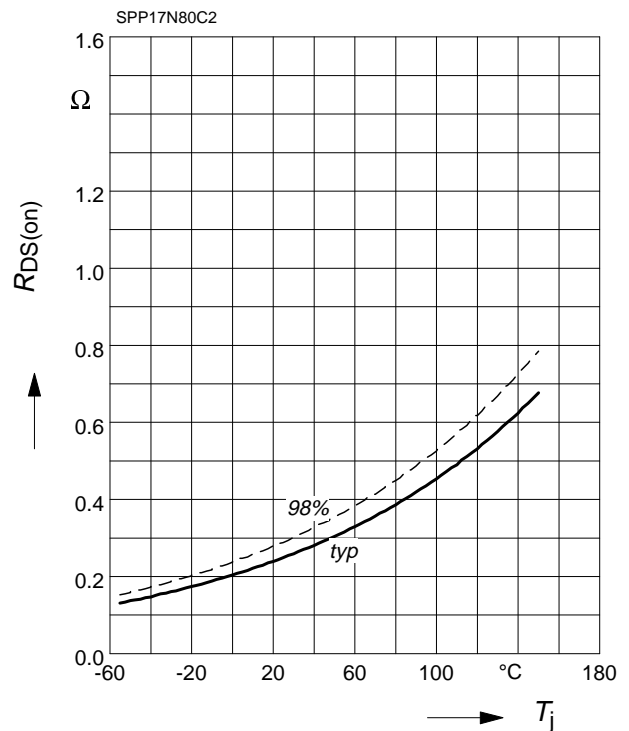

**9 Typ. transfer characteristics**

$I_D = f(V_{GS})$ ;  $V_{DS} \geq 2 \times I_D \times R_{DS(on)max}$   
parameter:  $t_p = 10 \mu s$

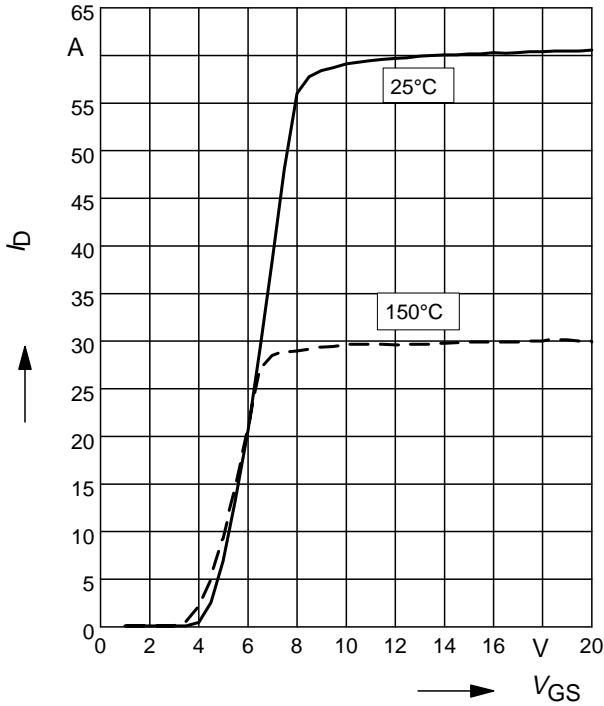

**10 Gate threshold voltage**

$V_{GS(th)} = f(T_j)$   
parameter:  $V_{GS} = V_{DS}$ ,  $I_D = 1 \text{ mA}$

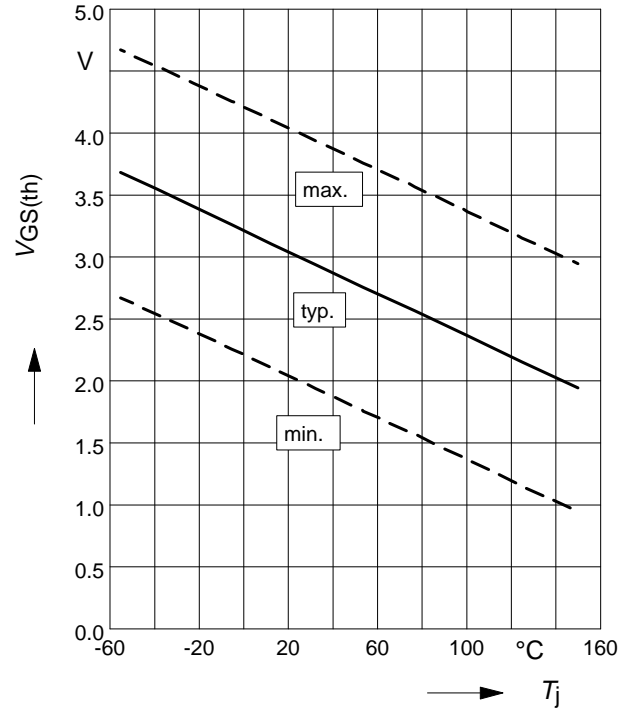

**11 Typ. gate charge**

$V_{GS} = f(Q_{Gate})$   
parameter:  $I_D = 17 \text{ A pulsed}$

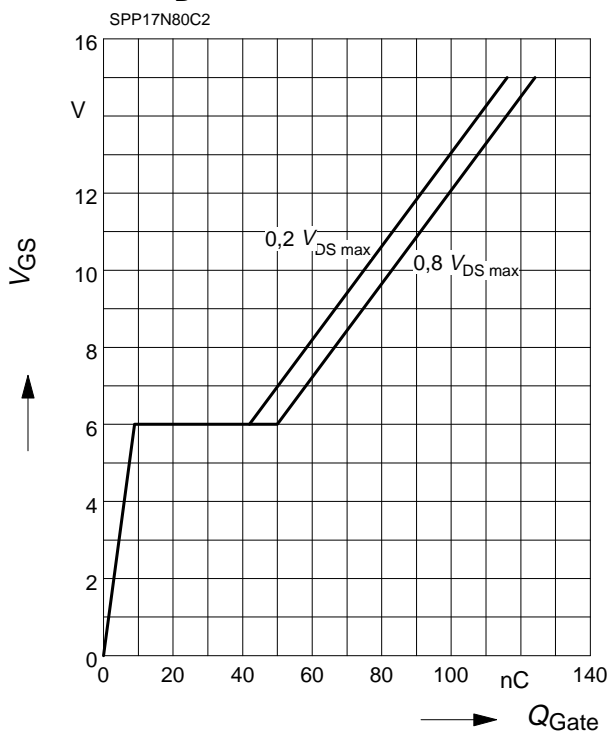

**12 Forward characteristics of body diode**

$I_F = f(V_{SD})$   
parameter:  $T_j$ ,  $t_p = 10 \mu s$

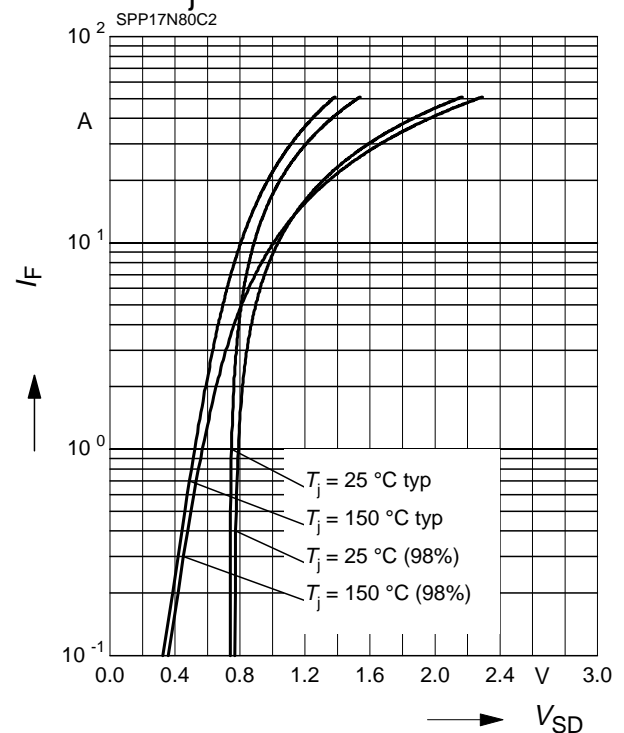

**13 Avalanche SOA**

$I_{AR} = f(t_{AR})$

par.:  $T_j \leq 150\text{ °C}$

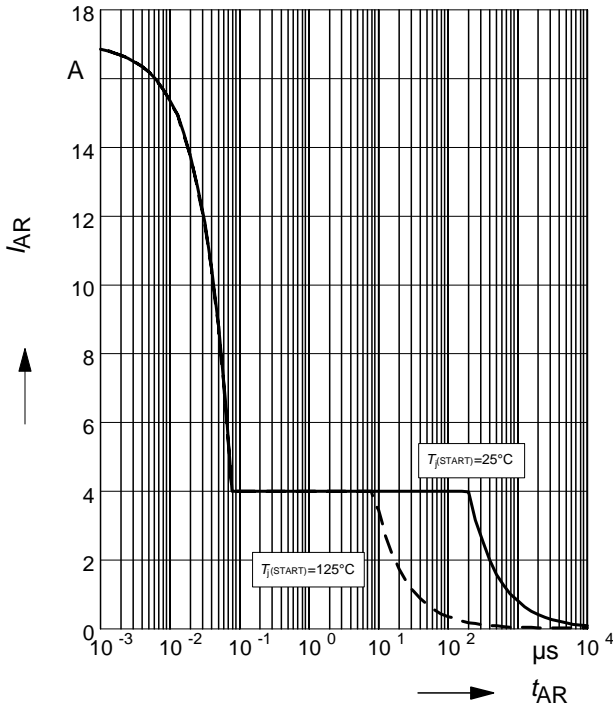

**14 Avalanche energy**

$E_{AS} = f(T_j)$

par.:  $I_D = 4\text{ A}, V_{DD} = 50\text{ V}$

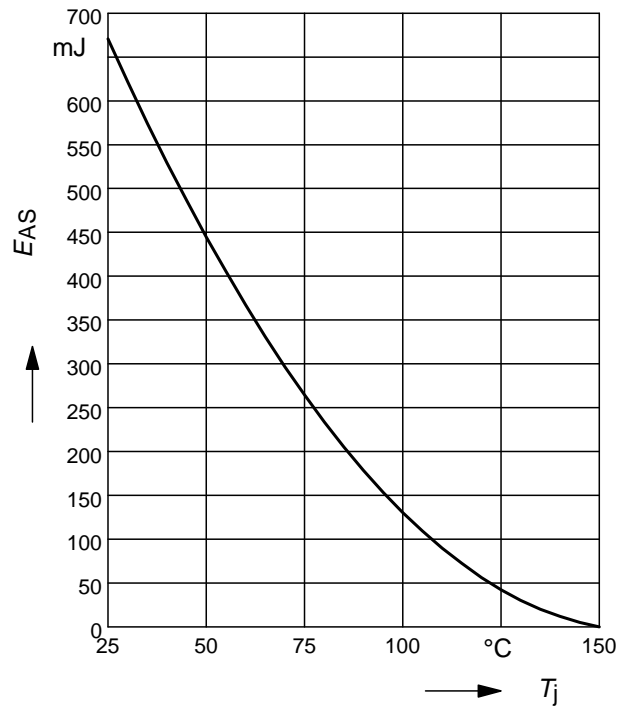

**15 Drain-source breakdown voltage**

$V_{(BR)DSS} = f(T_j)$

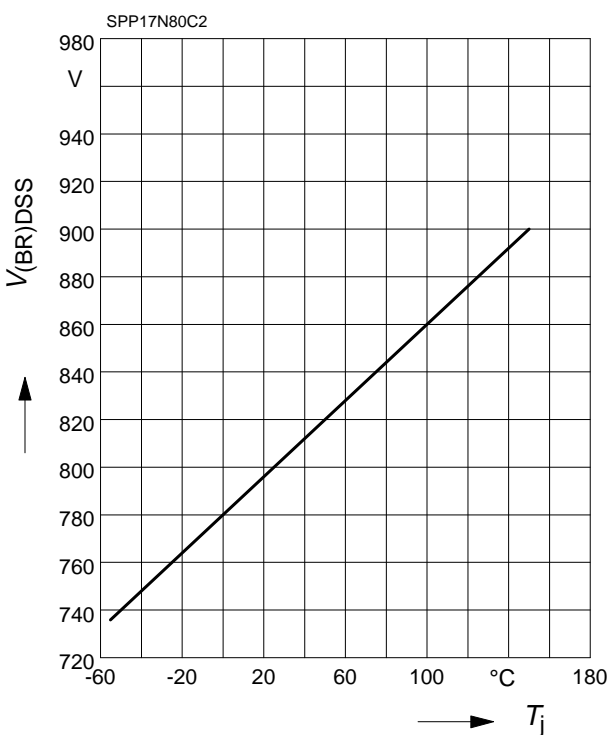

**16 Avalanche power losses**

$P_{AR} = f(f)$

parameter:  $E_{AR} = 0.5\text{ mJ}$

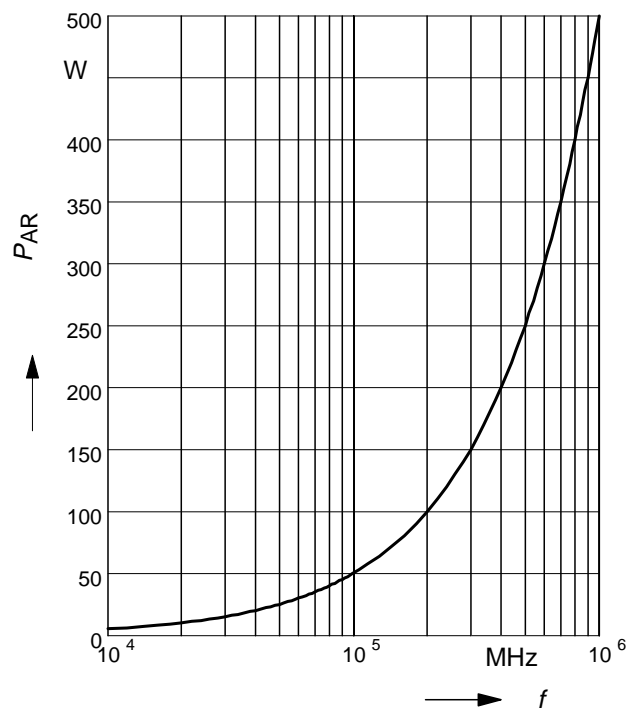



17 Typ. capacitances

$C = f(V_{DS})$

parameter:  $V_{GS}=0V, f=1\text{ MHz}$

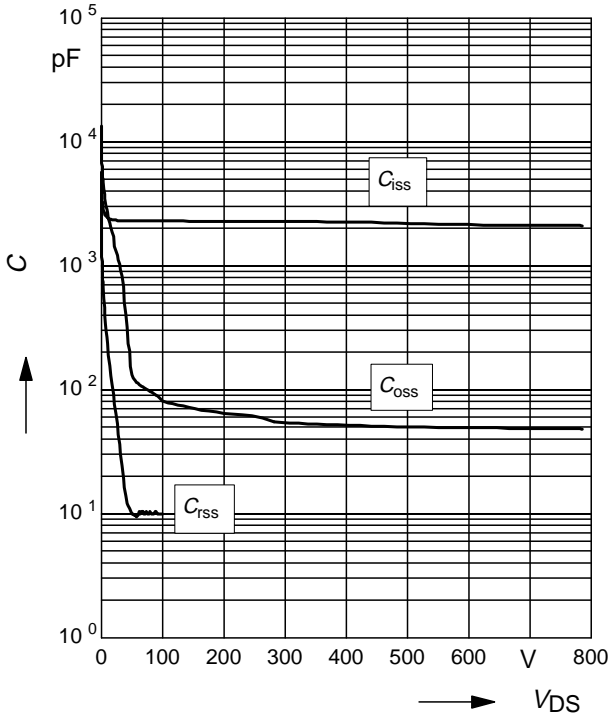

18 Typ. C<sub>OSS</sub> stored energy

$E_{OSS} = f(V_{DS})$

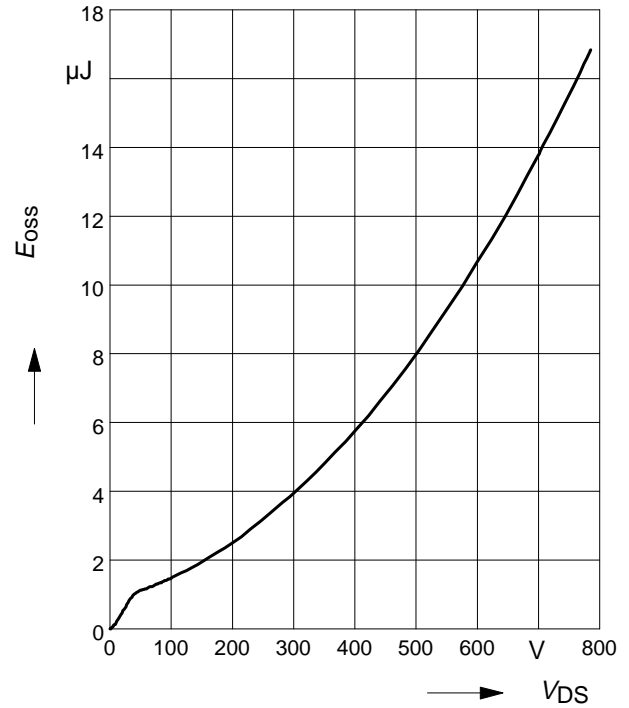

Definition of diodes switching characteristics

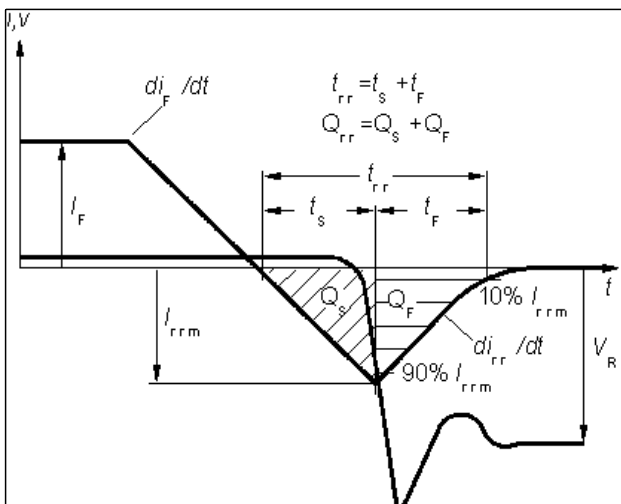

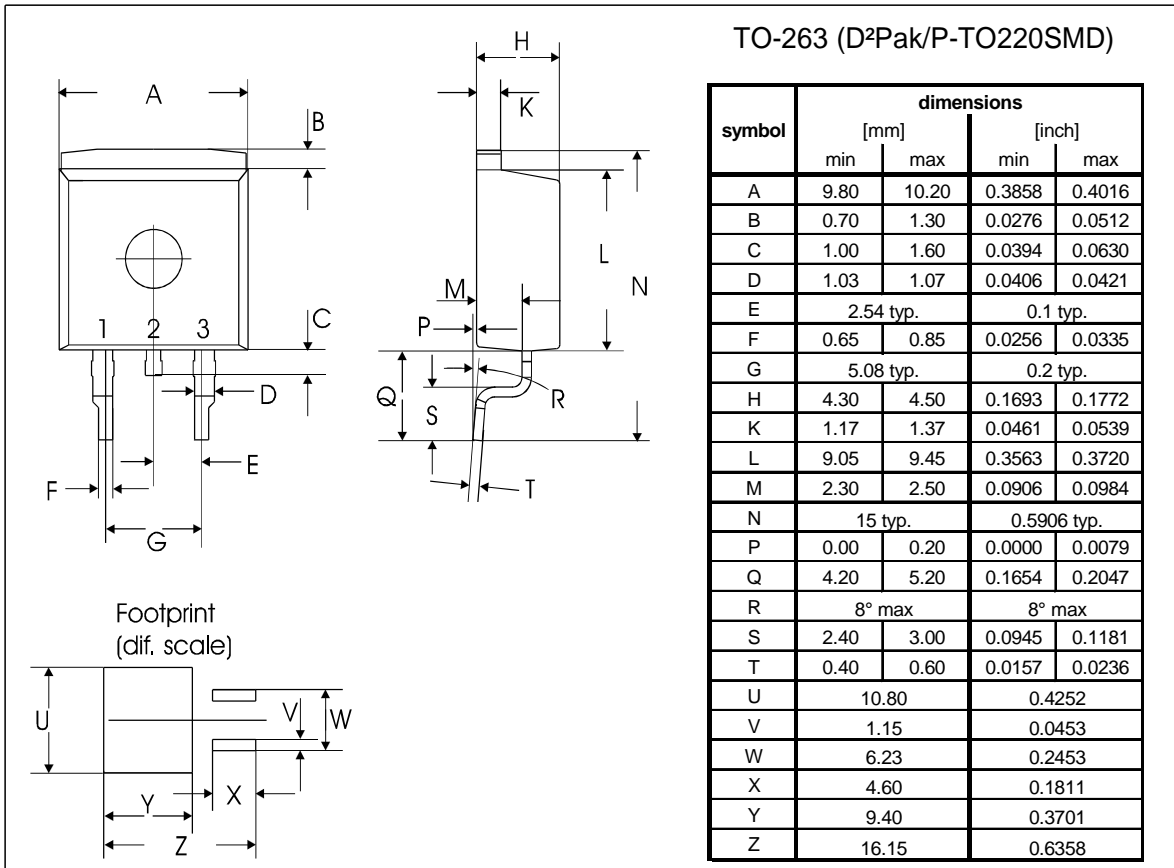
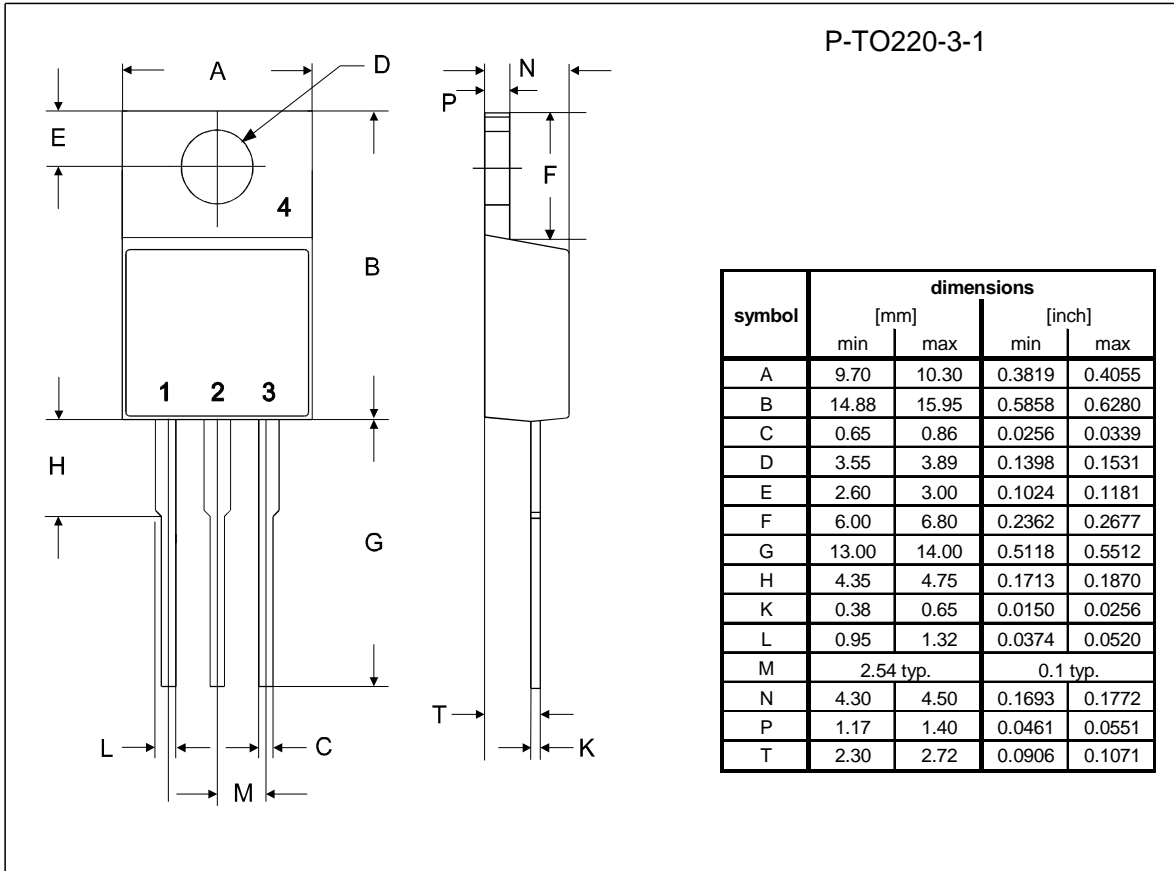

**Published by**  
**Infineon Technologies AG,**  
**Bereichs Kommunikation**  
**St.-Martin-Strasse 53,**  
**D-81541 München**  
**© Infineon Technologies AG 1999**  
**All Rights Reserved.**

**Attention please!**

The information herein is given to describe certain components and shall not be considered as warranted characteristics.

Terms of delivery and rights to technical change reserved.

We hereby disclaim any and all warranties, including but not limited to warranties of non-infringement, regarding circuits, descriptions and charts stated herein.

Infineon Technologies is an approved CECC manufacturer.

**Information**

For further information on technology, delivery terms and conditions and prices please contact your nearest Infineon Technologies Office in Germany or our Infineon Technologies Representatives worldwide (see address list).

**Warnings**

Due to technical requirements components may contain dangerous substances.

For information on the types in question please contact your nearest Infineon Technologies Office.

Infineon Technologies Components may only be used in life-support devices or systems with the express written approval of Infineon Technologies, if a failure of such components can reasonably be expected to cause the failure of that life-support device or system, or to affect the safety or effectiveness of that device or system. Life support devices or systems are intended to be implanted in the human body, or to support and/or maintain and sustain and/or protect human life. If they fail, it is reasonable to assume that the health of the user or other persons may be endangered.