



# USER MANUAL

## A Series

### Professional Power Amplifiers

Minimum 4 ohm

A500  
A700v  
A750  
A1000  
A1004  
A1500  
Q6  
Q1004  
QB1000/600

Minimum 2 ohm

A2000  
A3000  
A4000  
A5000  
A5003  
A6000  
Q900



# INSTALLATION

<b>UNPACKING</b>	<p><b>PLEASE READ THIS SECTION BEFORE USING THE AMPLIFIER.</b> <b>IF YOU HAVE ANY QUERIES, CONSULT AN AUTHORISED CHEVIN DEALER</b></p> <p>The carton contains the amplifier and:</p> <ul style="list-style-type: none"><li>▶ A700v: 1 x Neutrik Speakon plug</li><li>Q6, Q1004, QB1000/600, Q900: 4 x Neutrik Speakon plugs</li><li>All other models: 2 x Neutrik Speakon plugs</li><li>▶ User manual &amp; warranty card Please make a note of the serial number (on rear panel) <input type="text"/></li></ul> <p><input checked="" type="checkbox"/> Please complete &amp; return the warranty card. Failure to register may result in delays if you require warranty service. Full warranty details are at the back of this manual.</p> <p>? <b>IF ANY ITEM IS MISSING OR DAMAGED, CONTACT YOUR DEALER IMMEDIATELY.</b></p>
<b>COOLING &amp; ENVIRONMENTAL</b>	<ul style="list-style-type: none"><li>▶ A Series amplifiers draw in air at the back and expel it at the front: keep front &amp; back of unit free of obstruction.</li><li>▶ The amplifier may be used free-standing or installed in a 19" rack. If installed in a rack, the rear of the chassis should be supported. Rear rack-mount supports are integral on all models except the A500 &amp; A700v.</li></ul>
<b>VOLTAGE SELECTION</b>	<ul style="list-style-type: none"><li>▶ The amplifier is factory set to your local supply voltage</li></ul> <p>⚡ <b>WARNING: THE VOLTAGE SHOULD ONLY BE CHANGED BY AN AUTHORISED CHEVIN DEALER</b></p>
<b>AC WIRING</b>	<ul style="list-style-type: none"><li>▶ The A500 &amp; A700v connect to the mains supply via a detachable power cable with integral connector (supplied).</li><li>▶ All other models connect to the mains supply via a fixed power cable, colour coded to European standard: Green/Yellow = Earth      Blue=Neutral      Brown= Live</li></ul> <p>N.B.</p> <ul style="list-style-type: none"><li><input type="checkbox"/> The live connector in certain 115V models is coloured RED.</li><li><input type="checkbox"/> The amp must be connected to a 3-pin grounded outlet via a 3-pin connector of sufficient voltage and current rating. If the connector has provision for a fuse, a suitable fuse must be fitted.</li><li><input type="checkbox"/> The A5000, A6000 and Q900 have 2 power cables</li></ul> <p>⚡ <b>WARNING: ALL CHEVIN AMPLIFIERS MUST BE EARTHED</b></p>
<b>MAINS POWER SUPPLY</b>	<p>The power rating of the supply should be at least twice the total audio output of the system.</p> <p>⚡ <b>ELECTRIC SHOCK/FIRE HAZARD: The unit must be connected to an adequately rated grounded outlet. All cables, switch gear et al must be adequately rated to avoid risk of overheating &amp; fire.</b></p>
<b>THREE PHASE SYSTEMS</b>	<p>The neutral current will not balance on three-phase systems.</p> <ul style="list-style-type: none"><li>▶ Use individual neutral connections from each phase outlet back to the distribution point.</li><li>▶ Alternatively, ensure the neutral conductor is of sufficient capacity to handle a return current equal to the sum total of the current in the three phases.</li></ul>
<b>INPUT CONNECTIONS</b>	<p>All amplifiers are fitted with XLR connectors on the inputs. All inputs are electronically balanced and can accept signal from balanced &amp; unbalanced sources.</p> <ul style="list-style-type: none"><li>▶ A500 and A700v: One female XLR connector on the input of each channel.</li><li>▶ A750, A1000, A1004, A1500, A2000, A3000, A4000, A5000, A5003, A6000, Q900: One male &amp; one female XLR connector on the input of each channel. These connectors are wired in parallel.</li><li>▶ Q6, Q1004 &amp; QB1000/600: One female XLR connector on the input of each channel.</li></ul> <p>N.B. The amps are not mixing amplifiers: do not directly connect any channel to more than 1 signal source. Maintain the same phase polarity on all equipment in signal chain.</p> <p><b>PIN WIRING - MALE &amp; FEMALE XLR INPUT SOCKETS</b></p> <ul style="list-style-type: none"><li>▶ PIN 1: GROUND, connects directly to chassis    PIN 2: HOT (+)    PIN 3: COLD(-)</li></ul> <p><b>CONNECTION TO BALANCED SOURCES</b></p> <ol style="list-style-type: none"><li>1. Fit XLR connectors at both ends of the cable.</li><li>2. PIN 1 connects via the cable braid (screen). Always connect the screen at both ends of the cable.</li><li>3. PINS 2 &amp; 3 connect via the two signal wires of the cable.</li></ol> <p><b>CONNECTION TO UNBALANCED SOURCES</b></p> <ol style="list-style-type: none"><li>1. At the SOURCE END of the cable, the cable screen &amp; cold (-) signal wire connect to the chassis of the source equipment via the sleeve of the jack plug/phono connector/PIN 1 of the XLR-type plug.</li><li>2. The signal carrying conductor (which connects to PIN 2 of the XLR at the amp end) connects to the HOT output terminal of the source equipment via the jack plug tip/phono connector pin/signal-carrying XLR pin</li></ol>



# INSTALLATION

## OUTPUT CONNECTIONS

Connection is made to the amplifier's load via Neutrik Speakon sockets. As with input connectors, maintain phase polarity throughout the system.

### Speakon Socket Wiring

**A500** 1 Speakon socket per channel, wired as follows:

1+ = HOT	2+ = NO CONNECTION
1- = GROUND	2- = GROUND

**A700v** 1 Speakon socket per channel, wired as follows:

1+ = HOT	2+ = NO CONNECTION
1- = COLD (not ground)	2- = NO CONNECTION

⚡ **WARNING:** The A700v output is permanently connected in bridge mode. Both hot and cold outputs carry high level signal. Further bridging is impossible. No terminal of the speaker socket is connected to ground. Do not connect any part of the speaker system to ground.

**A750, A1000, A1004, A1500, A2000, A3000, A4000, A5003, Q900**

2 parallel-connected Speakon sockets per channel, wired as follows:

1+ = HOT	2+ = NO CONNECTION
1- = GROUND	2- = GROUND

**A5000/ A6000** Two (2) parallel- connected Speakon sockets per channel, wired as follows:

1+=HOT	2+= NO CONNECTION
1-=COLD (not ground)	2-= COLD (not ground)

⚡ **WARNING:** The A5000 & A6000 outlets are permanently connected in bridge mode. Both hot & cold outputs carry high level signal. Further bridging is impossible. Do not connect any part of the A5000 and A6000 outputs to the ground. Take care when using loudspeaker controllers or processors.

**Q6, Q1004** One Speakon socket per channel, parallel connected in channel pairs: A&B, C&D.

Each socket in the pair carries the output of both channels. Wiring as follows:

- Channel A socket (600 watts) carries its own & Ch. B's 600 watt output.
- Channel B socket (600 watts) carries its own & Ch. A 's 600 watt output.
- The same applies to Channel C & D sockets.

Channel A & C Sockets:	1+ = HOT (Ch. A & C output)	1- and 2- = GROUND
	2+ = HOT (Ch. B & D output, respectively)	

Channel B & D Sockets:	2+ = HOT (Ch. B & D output)	1- and 2- = GROUND
	1+ = HOT (Ch. A & C output, respectively)	

**QB1000/600** One Speakon socket per channel, internally configured as follows:

- Channel A socket (600 watts) carries both its own & Ch. B's 1000 watt output.
- Channel B socket carries only its own 1000 watt output.
- Channel C socket carries only its own 1000 watt output.
- Channel D socket (600 watts) carries both its own & Ch. C's 1000 watt output.

Outer sockets	Ch A & D:	1+ = HOT (600 watts output)	1- and 2- = GROUND
		2+ = HOT (1000 watts output)	1- and 2- = GROUND

Inner sockets	Ch B & C:	2+ = HOT (1000 watts output)	1- and 2- = GROUND
---------------	-----------	------------------------------	--------------------

⚡ **WARNING:** High voltages are present at output terminals during operation & for a period afterwards. Do not connect the amp output to any other amp output or to any other equipment except a loudspeaker system

### Loudspeaker Power Ratings

Suggested speaker ratings, per amplifier channel, in watts.

MODEL	16Ω	8Ω	4Ω	2Ω	
A500	115	230	460	-	
A750	160	300	600	-	
A1000/Q6	230	450	900	-	
A1004/Q1004	400	750	1500	-	
A1500	500	1000	1900	-	
QB1000/600	A&D	230	450	900	-
	B&C	400	750	1500	-
A2000	230	500	1000	1800	
A3000	350	650	1300	2300	
A4000	450	800	1500	3000	
A5003/A5000	500	1000	2000	3600	
A6000	800	1200	2600	4500	
Q900	350	650	1300	2300	

# ▲ INSTALLATION

<b>Loudspeaker Impedance</b>	<p><b>Correct total loading for the amplifiers is as follows. Multiple speakers are connected in parallel</b>  <b>A500, A750, A1000, A1004, A1500, Q6, Q1004, QB1000/600 per channel</b></p> <p style="text-align: center;">4 or less speakers of 16Ω                      OR    2 or less speakers of 8Ω                      OR 1 speaker of 4Ω  <b>WARNING: Do not use a system with a total impedance per channel of under 4 ohms</b></p> <p><b>A2000, A3000, A4000, A5003, A5000, A6000, Q900 per channel</b></p> <p style="text-align: center;">8 speakers or less of 16Ω                      OR    4 or less speakers of 8Ω  OR 2 or less speakers of 4Ω                      OR    1 speaker of 2Ω  <b>WARNING: Do not use a system with a total impedance per channel of under 2 ohms.</b></p>
------------------------------	--

<b>A700V Loudspeaker Power Ratings &amp; Impedance</b>	<p><b>Power Handling.</b> The A700v can be used to drive a 70 volt distribution system or to drive a conventional system, as follows:</p> <p><b>Line Operation</b>                      <input type="checkbox"/> 70 volt (maximum loading 600 watts)  <input type="checkbox"/> Can drive 100 volt line system at reduced output.</p> <p><b>N.B.</b> Don't connect a transformer between the A700v output and distribution system  Where line transformers are used to match speakers to the distribution system, adjust to suit characteristics of the speaker.</p> <p><b>Conventional Speaker System</b></p> <table style="margin-left: auto; margin-right: auto; border-collapse: collapse;"> <tr> <td style="border-bottom: 1px solid black; width: 100px;"></td> <td style="border-bottom: 1px solid black; width: 50px; text-align: center;">16Ω</td> <td style="border-bottom: 1px solid black; width: 50px; text-align: center;">8Ω</td> <td style="border-bottom: 1px solid black; width: 50px; text-align: center;">4Ω</td> <td style="border-bottom: 1px solid black; width: 50px; text-align: center;">2Ω</td> </tr> <tr> <td style="text-align: center;">A700v</td> <td style="text-align: center;">450</td> <td style="text-align: center;">900</td> <td style="text-align: center;">-</td> <td style="text-align: center;">-</td> </tr> </table> <p style="text-align: center;"><b>WARNING: Do not use a system with a total impedance per channel of under 8 ohms.</b></p>		16Ω	8Ω	4Ω	2Ω	A700v	450	900	-	-
	16Ω	8Ω	4Ω	2Ω							
A700v	450	900	-	-							

<b>PRE-SET LIMITER</b>	<p>The A6000 and A5000 (4u) models incorporate an adjustable output limiting control, concealed behind the front panel  Consult an authorised Chevin dealer if you wish to make use of this feature.</p>
------------------------	--

# ▲ OPERATION

<b>Power Up</b>	<p>Connect the unit to the mains supply and switch on. The green power LEDs illuminate. The fans may run, depending on temperature. The green signal LEDs illuminate when signal is present.  The red clip LEDs illuminate if overdriving is imminent.</p>
<b>Power Down</b>	<p>Turn the gain controls to minimum position. Switch off the amp &amp; disconnect from the mains power supply.</p>
<b>Protection Systems</b>	<p><b>Mains power supply failure.</b> When power is restored, the amp AutoMutes for 10 seconds.  Do not increase gain settings during this period.                      <b>Please note the A500 &amp; A700v do not AutoMute.</b></p> <p><b>Shorted output.</b> The unit can operate indefinitely into a shorted output. Normal operation will resume upon removal of the short circuit.</p> <p><b>Low load impedance.</b> Protection is immediate.</p> <p><b>Clipping.</b> The affected channel's red Clip LED illuminates shortly before clipping. A further increase in signal level will activate the soft-clip circuit.</p> <p><b>RF, DC or very low frequency signal at output.</b> A self-resetting circuit activates to protect the load.</p> <p><b>Cooling systems.</b> The internal fans react to both signal level and temperature inside the unit. If the ambient temperature is high, fan speed will increase even in the absence of signal.</p>
<b>Sound Levels</b>	<p style="text-align: center;"><b>WARNING: keep sound levels down! High levels of sound can damage hearing.</b></p>

# ▲ SERVICING

<b>Maintenance</b>	<p><b>WARNING: ALL SERVICING AND INTERNAL MAINTENANCE MUST BE REFERRED TO AN AUTHORISED CHEVIN DEALER</b></p> <p>Do not remove any covers or touch any internal parts  <u>Do not allow any objects, for example screwdrivers or cable ends, to enter the unit.</u></p>
<b>Damage</b>	<p><b>Water.</b> If the unit or any other electrical equipment in the system becomes wet during operation, immediately disconnect the power at source. Do not touch the amplifier. Consult a qualified engineer</p> <p><b>Mechanical.</b> If there are any signs of mechanical damage - for example, broken parts, covers or fans guards pushed in, loose internal parts, mains cable damage etc. - disconnect the amplifier from the mains and consult a qualified engineer.</p> <p style="text-align: center;"><b>WARNING</b></p> <p style="text-align: center;">Chevin Research accepts no responsibility or liability relating to injury or damages suffered as a result of misuse or unauthorised tampering with any of its amplifiers</p>



# MONO BRIDGE MODE

**⚡ WARNING: YOU CANNOT BRIDGE THE A700v, A5000 (4U), A6000 or QB1000/600**

**INPUT CONNECTIONS**

**A500**

1. Make a lead with a suitable connector for the source equipment and two (2) XLR plugs for the amplifier end.
2. The HOT output from the source equipment goes to Pin 2 of Ch. A XLR plug and Pin 3 of Ch. B XLR plug
3. The COLD connection from the source equipment goes to Pin 3 of Ch A. XLR plug and to Pin 2 of CH. B XLR plug
4. The cable screen connects to Pin 1 of the XLR plugs in both cases

**A750, A1000, A1004, A1500, A2000, A3000, A4000, A5003, Q900**

1. Bring the input signal into Channel A as usual.
2. Make a link cable with XLR plugs at both ends to go from Ch. A LINK socket to Ch. B INPUT socket.
3. Pin 2 at one end connects to Pin 3 at the other end: that is, PIN 2-3 and PIN 3-2

**Re the Q900: repeat the above procedure to bridge Channels C&D**

**OUTPUT CONNECTIONS**

**A500, A750, A1000, A1004, A1500, A2000, A3000, A4000, A5003, Q900**

1. Split the speaker cable by separating the 2 conductors for a distance of 20cm along the cable.
2. Connect the red conductor to Terminal 1+ of the Ch. A Speakon connector
3. Connect the black conductor to Terminal 1+ of the Ch. B Speakon connector

**Re the Q900: repeat the above procedure to bridge Channels C&D**

**⚡ WARNING: Do not make connections to any other terminals.**

**OPERATION**

▶ **Set both channels' gain controls in the same position, preferably at maximum, and control the gain from elsewhere in the system. This ensures the load is shared equally between channels.**

**LOADING & POWER OUTPUT**

<b>A500</b>	one (1) load of 8Ω minimum.	Power output is 650 watts.
<b>A750</b>	one (1) load of 8Ω minimum.	Power output is 850 watts.
<b>A1000</b>	one (1) load of 8Ω minimum.	Power output is 1200 watts.
<b>A1004</b>	one (1) load of 8Ω minimum.	Power output is 2000 watts.
<b>A1500</b>	one (1) load of 8Ω minimum.	Power output is 2500 watts.
<b>A2000</b>	one (1) load of 4Ω minimum.	Power output is 2400 watts.
<b>A3000</b>	one (1) load of 4Ω minimum.	Power output is 3000 watts.
<b>A4000</b>	one (1) load of 4Ω minimum.	Power output is 4000 watts.
<b>A5003/A5000</b>	one (1) load of 4Ω minimum.	Power output is 5000 watts.
<b>Q900</b>	one (1) load of 4Ω minimum per channel pair.	Power output is 3000 watts per channel pair.

**Q6, Q1004**

**INPUT CONNECTIONS**

**Make a lead with a connector at the source end and two (2) XLR plugs at the amp end. Wiring as follows:**

1. The source equipment HOT output goes to PIN 2 of Ch. A (C) XLR plug and PIN 3 of Ch. B (D) XLR plug.
2. The COLD connection from the source equipment must go to PIN 3 of the Ch. A (C) XLR plug and PIN 2 of the Ch. B (D) XLR plug.
3. The cable screen connects to PIN 1 of the XLR plugs in both cases.

**OUTPUT CONNECTIONS**

1. Connect the RED conductor of the speaker cable to Terminal 1+ of Ch. A (C) Speakon connector.
2. Connect the BLACK conductor of the speaker cable to Terminal 2+ of Ch. B (D) Speakon connector.

**⚡ WARNING: Do not make connections to Terminals 1- or 2-.**

**OPERATION**

▶ **Set both channels' gain controls in the same position, preferably at maximum, and control the gain from elsewhere in the system. This ensures the load is shared equally between channels.**

**LOADING & POWER OUTPUT**

<b>Q6</b>	one (1) load of 8Ω minimum per channel pair.	Power output is 1200 watts per channel pair.
<b>Q1004</b>	one (1) load of 8Ω minimum per channel pair.	Power output is 2000 watts per channel pair.

# FRONT PANELS

A500

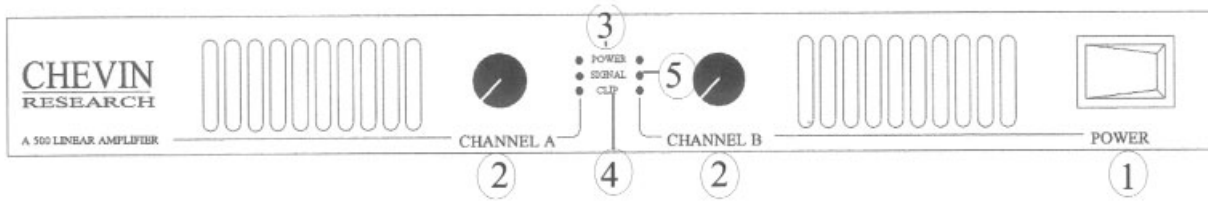

A700V

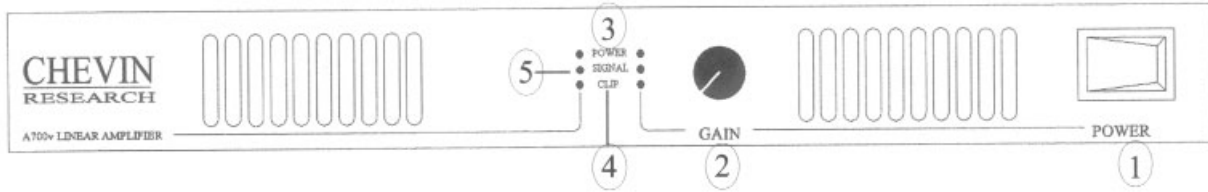

A750, A1000, A1004, A1500, A2000, A3000

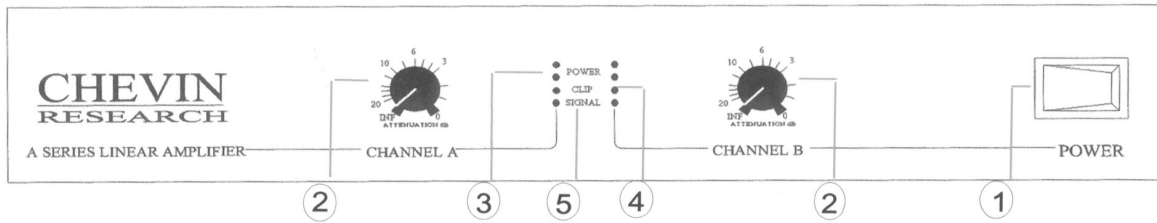

A4000, A5003

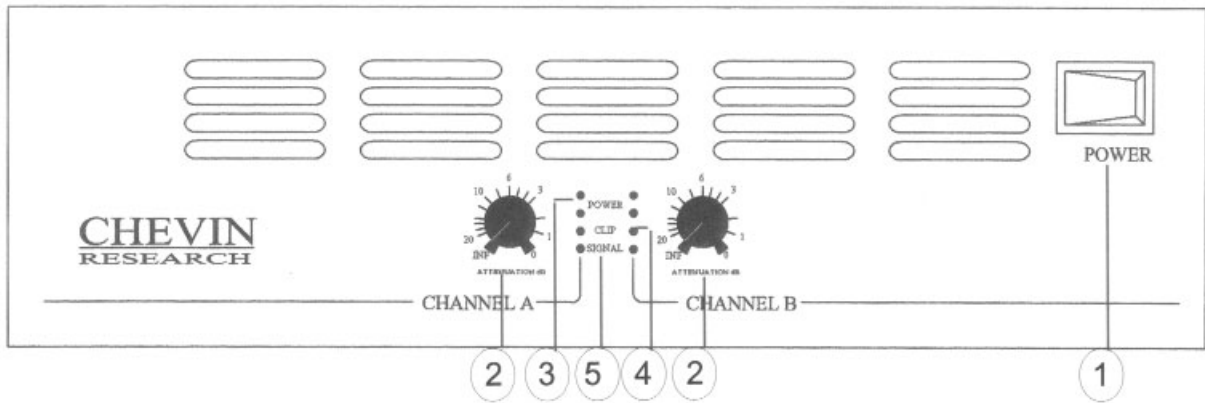

Q6

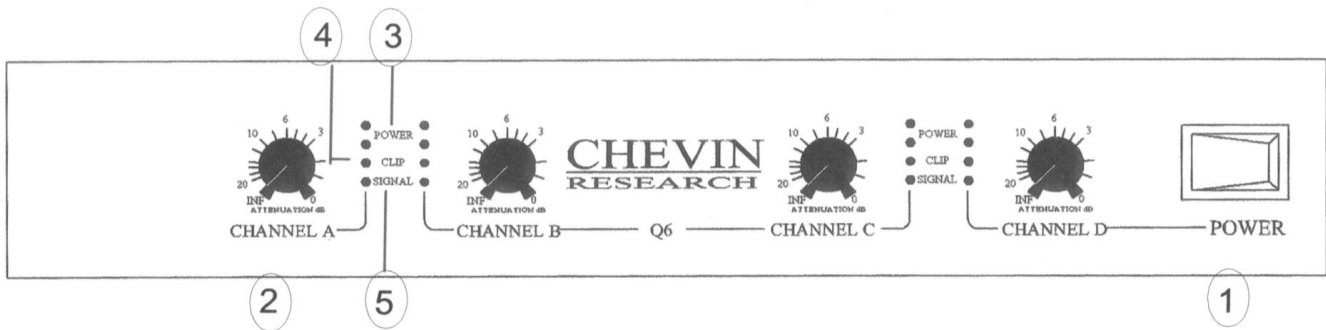

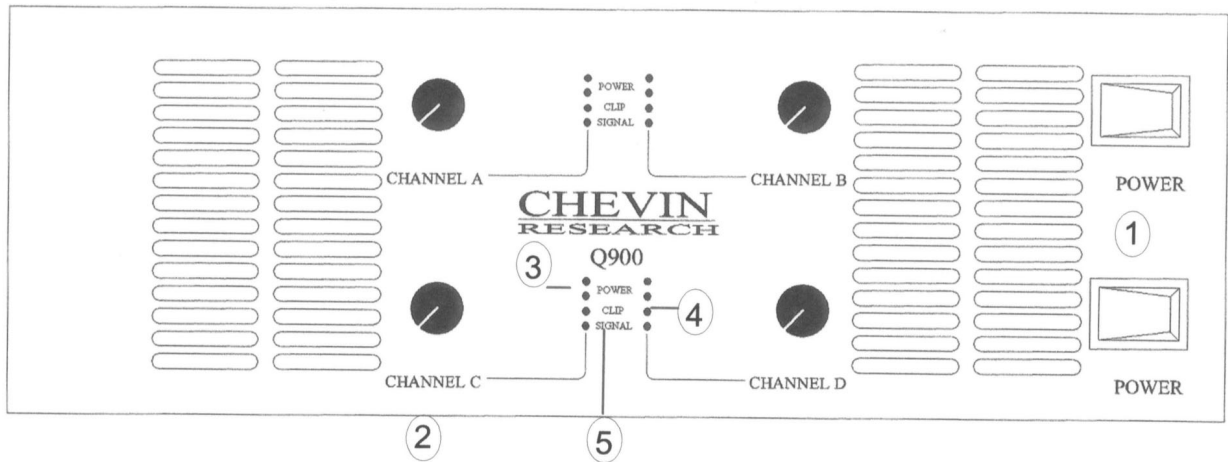
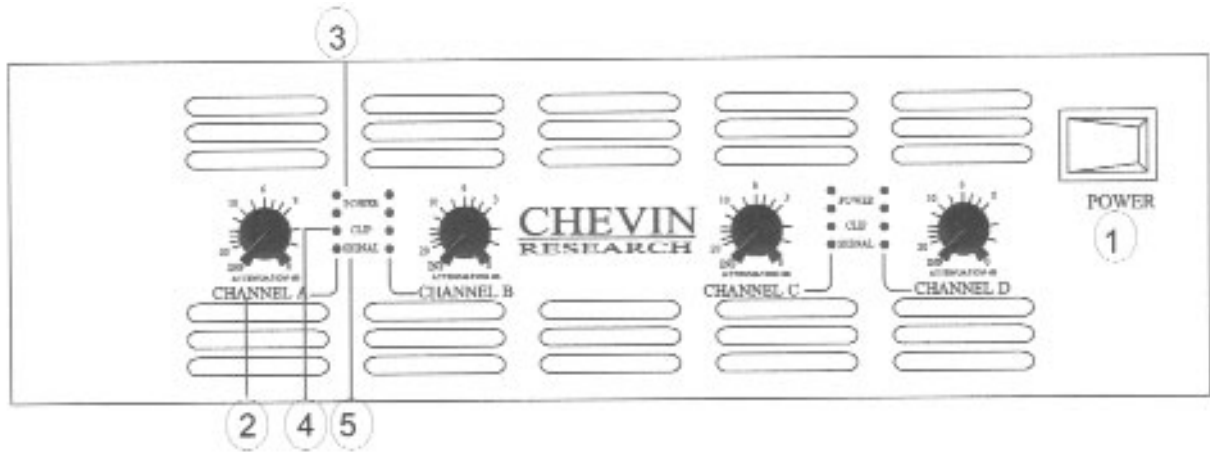

- |                    |  |
|--------------------|--|
| 1. Power Switch    | Controls the mains power supply to the amplifier   |
| 2. Output Controls | Controls the output level (gain) of each channel   |
| 3. Power LEDs      | Top green LEDs. They illuminate when the unit is ON  |
| 4. Clip LEDs       | Red LEDs, one per channel. They illuminate when the unit is being driven into clip and indicate the SoftClip system is active. |
| 5. Singnal LEDs    | Bottom green LEDs. They illuminate when the signal is present<br>On the A500 & A700V, the signal LEDs are in the middle.       |

A5000 & A6000

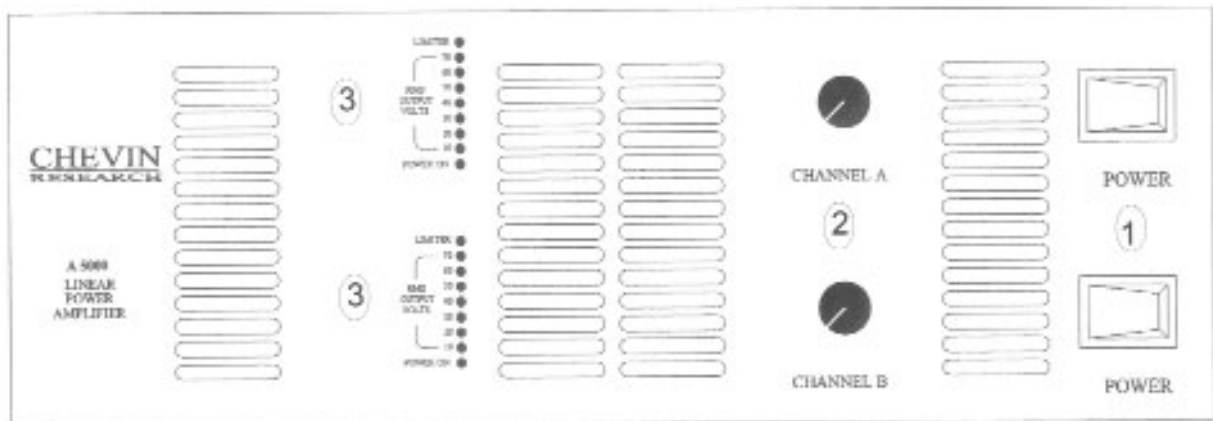

- |                    |  |
|--------------------|--|
| 1. Power Switch    | Controls the mains power supply to the amplifier   |
| 2. Output control  | Controls the output level (gain) of each channel   |
| 3. Output Bargraph | <ul style="list-style-type: none"> <li>▶ Power LED. The bottom green LED, illuminates when the unit is ON</li> <li>▶ Output Voltage LEDs. The column of green LEDs above the power LED. These give indication of the output voltage. Output power will be determined by load impedance. Illumination of the 70V LED indicates imminent clipping.</li> <li>▶ Clip LED. The top red LED. It illuminates when the amplifier is being driven into clip and indicates the SoftClip system is active. If the Clip threshold is exceeded, the intensity of this LED provides an indication of the degree of overdrive.</li> </ul> |

# BACK PANELS

A500

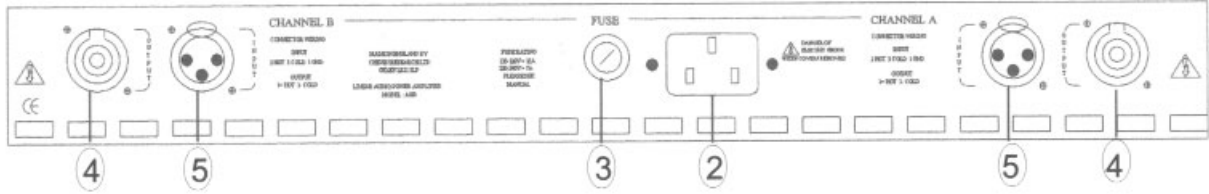

A700V

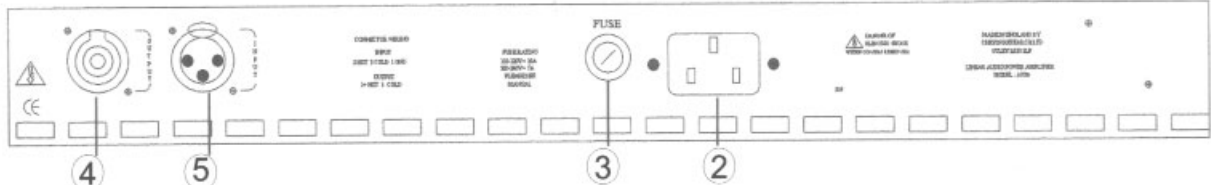

A750, A1000, A1004, A1500, A2000, A3000

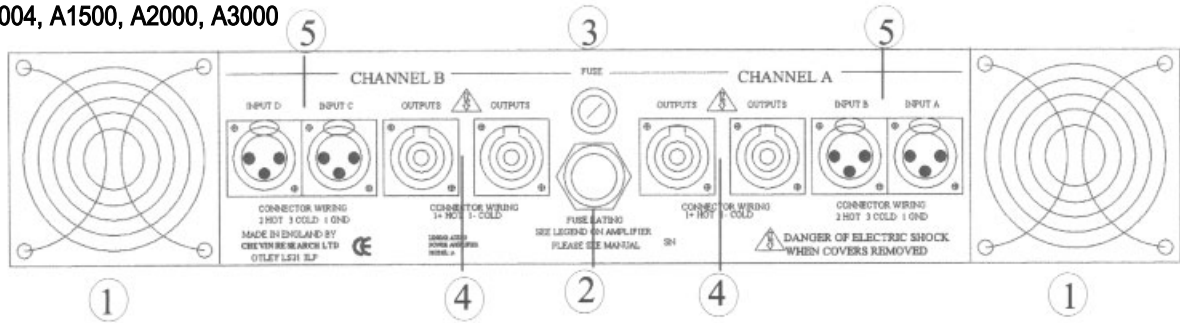

Q6

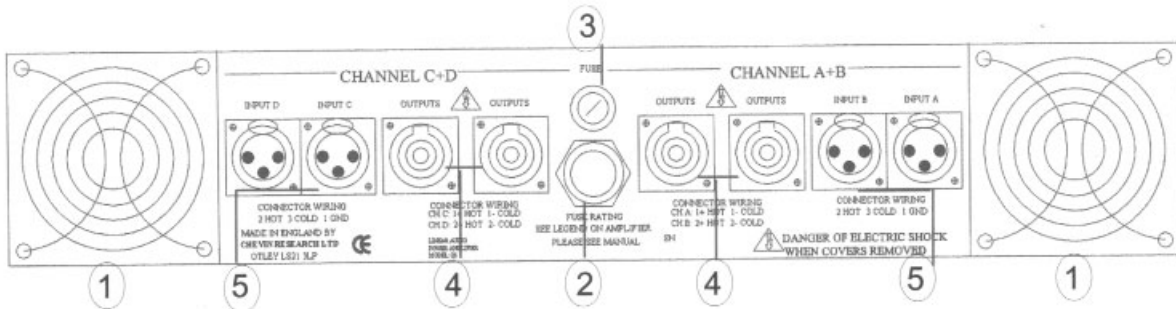

QB1000/600

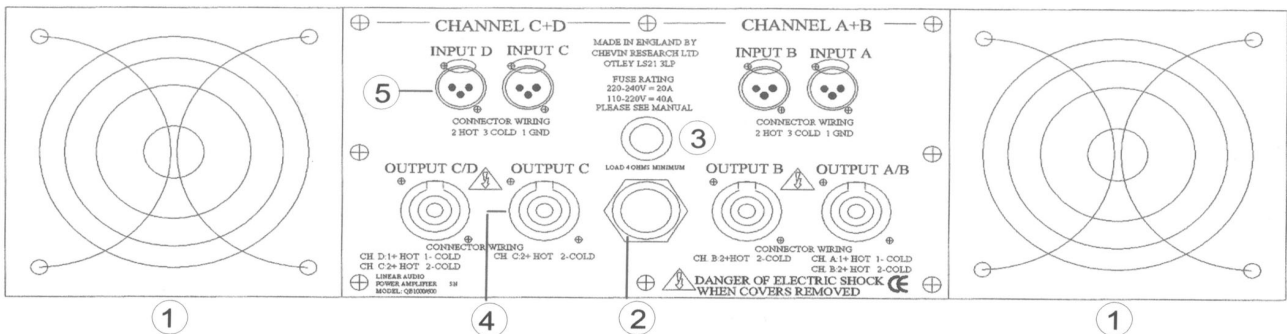

Q1004

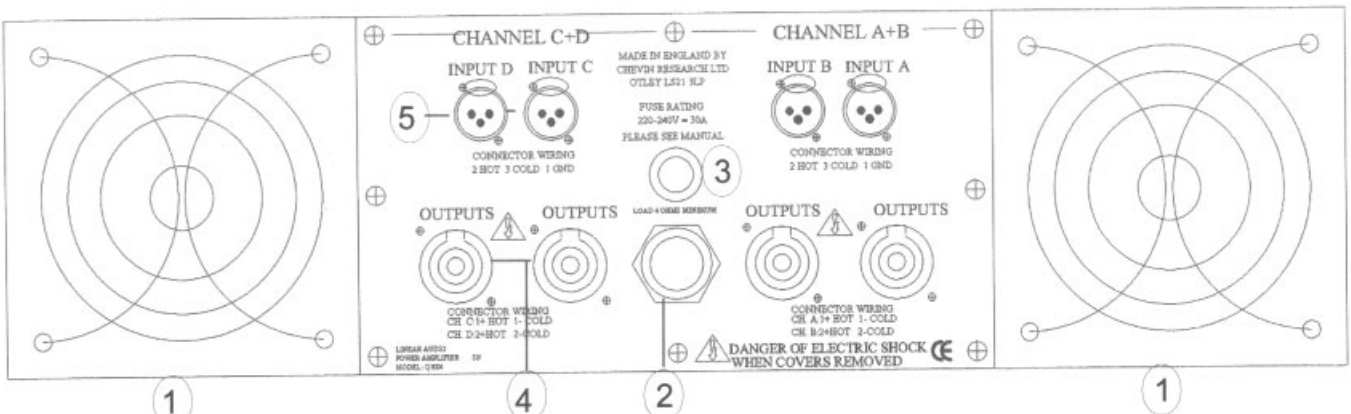



A4000

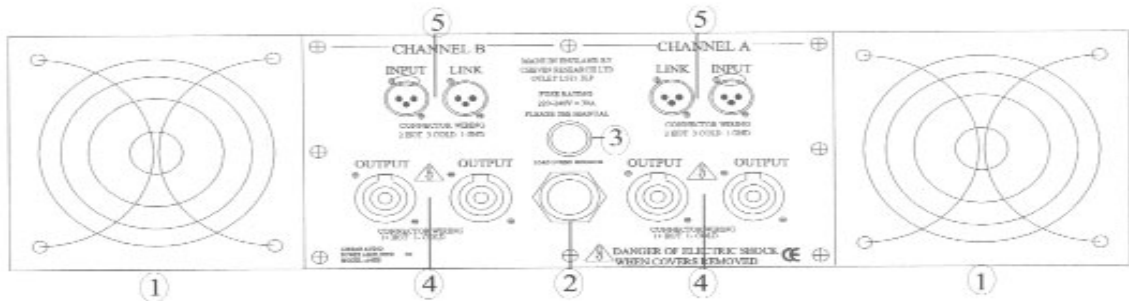

A5003

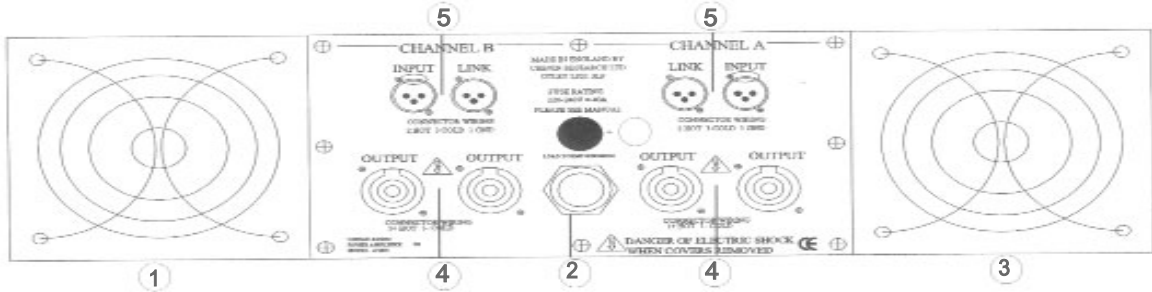

Q900

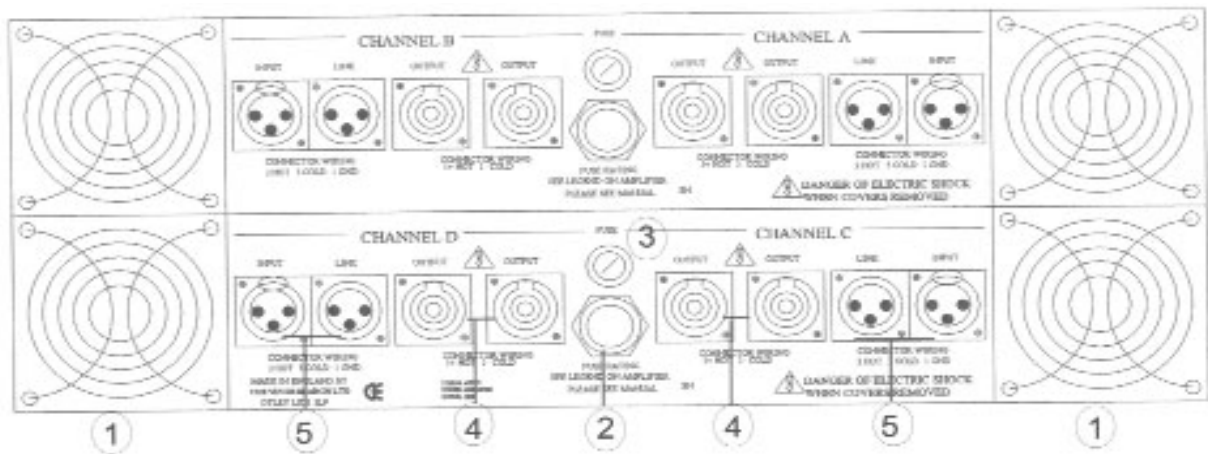

A5000/A6000

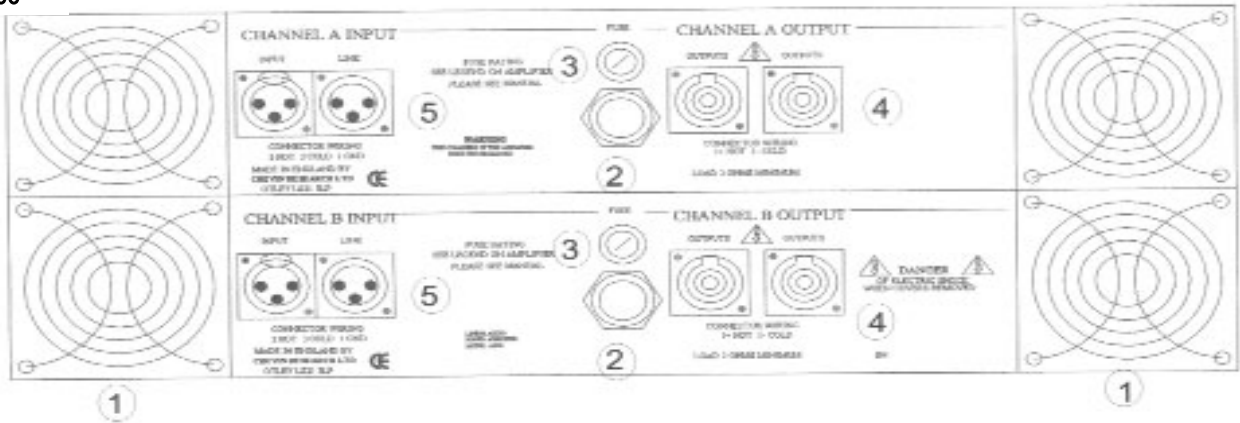

1. Vari Speed Fans

- ▶ On the A500 & A700V, the fan is internal. On all other models, fans are at the back. These spin at variable speeds depending on the signal level and ambient temperature

2. Mains Input

- ▶ On the A500 & A700V, mains input is via a detachable 3-core main cable with integral connector.
- ▶ All other models have a fixed, high current 3-core mains cable. Wiring as per standard European colour coding.

3. Mains Fuse

- ▶ Correct fuse rating indicated on the back panel legend. **Please note the A5003 fuse is internal**

4. Output Connectors

**Neutrik Speakon sockets.** Pin wiring indicated on legend

- ▶ A500, A700, Q6, Q1004, QB1000/600: One per channel
- ▶ A750, A1000, A1004, A1500, A2000, A2500, A3000, A4000, A5000, A5003, A6000, Q900: Two per channel

5. Input Connectors

**XLR sockets.** Pin and wiring indicated on legend.

- A500, A700v, Q6, Q1004, QB1000/600: One female XLR connector per channel.
- A750, A1000, A1004, A1500, A2000, A2500, A3000, A4000, A5000, A5003, A6000, Q900: One male and one female XLR connector per channel.

# SPECIFICATIONS

Specifications	A500	A1000	A1004	A1500	Q6	Q1004	QB1000/600
<b>RMS Power Output</b>							
into 4Ω, watts per channel	350	600	1000	1250	600	1000	2 x 1000/ 2 x 600
into 8Ω, watts per channel	200	350	600	650	350	600	2 x 600 / 2 x 375
<b>No of Channels</b>	2	2	2	2	4	4	4
<b>Power Bandwidth</b> +0dB, - 3dB	2Hz-40kHz	2Hz-80kHz	2Hz-80kHz	2Hz-80kHz	2Hz-80kHz	2Hz-80kHz	2Hz-80kHz
<b>Slew Rate</b> in excess of	40V/μs	75V/μs	75V/μs	60V/μs	75V/μs	75V/μs	75V/μs
<b>Gain</b>	x 37.5	x 50	x 65	x 70	x 50	x 65	x 65 / x 50
<b>Total Harmonic Distortion</b>							
Typical @ 1 dB below clip	0.06%	0.04%	0.04%	0.04%	0.04%	0.04%	0.04%
20kHz @ 1dB below clip	0.08%	0.07%	0.07%	0.07%	0.07%	0.07%	0.07%
<b>Signal to Noise Ratio</b>							
Typical ref. full output, unweighted	-120dB	-125dB	-125dB	-125dB	-125dB	-125dB	-125dB
Worst case 10Hz - 30kHz	-95dB	-95dB	-95dB	-95dB	-95dB	-95dB	-95dB
<b>Crosstalk</b>							
Typical	-115dB	-115dB	-115dB	-115dB	-115dB	-115dB	-115dB
Worst case 10Hz - 30kHz	-95dB	-95dB	-95dB	-95dB	-95dB	-95dB	-95dB
<b>Damping Factor</b>	400	400	400	400	400	400	400
<b>Input Impedance</b>							
electronically balanced	10k Ohm	10k Ohm	10k Ohm	10k Ohm	10k Ohm	10k Ohm	10k Ohm
<b>Common Mode Rejection</b>							
typically	-70dB	-70dB	-70dB	-70dB	-70dB	-70dB	-70dB
<b>Input Sensitivity</b>							
ref. full output into 4 ohms	IV RMS	IV RMS	IV RMS	IV RMS	IV RMS	IV RMS	IV RMS
<b>Protection</b>							
Clipping	Soft	Soft	Soft	Soft	Soft	Soft	Soft
Load Below 2.4 ohms	Dynamic linear	Dynamic linear	Dynamic linear	Dynamic linear	Dynamic linear	Dynamic linear	Dynamic linear
Shorted Output, DC or RF at output	Immediate	Immediate	Immediate	Immediate	Immediate	Immediate	Immediate
<b>Power Consumption</b>	1.2kVA	2kVA	3.3kVA	4kVA	4kVA	6.6kVA	5.2kVA
<b>Power Requirements</b>							
50/60Hz ac in volts	220- 240v	220- 240v	220- 240v	220- 240v	220- 240v	220- 240v	220- 240v
Internally selectable for	100-120v	100-120v	100-120v	100-120v	100-120v	N/A	100- 120v
<b>Dimensions</b>							
Rack Units	1u	2u	2u	2u	2u	3u	3u
Height x Width x Depth in inches	1.75 x 19 x 8.5	3.5 x 19 x 15	3.5 x 19 x 15	3.5 x 19 x 15	3.5 x 19 x 15	5.25 x 19 x 15	5.25 x 19 x 15
Height x Width x Depth in mm	44 x 483 x 215	88 x 483 x 381	88 x 483 x 381	88 x 483 x 381	88 x 483 x 381	132 x 483 x 381	132 x 483 x 381
<b>Weight</b>							
Gross in kg/lbs	5.2kg/11.5lbs	10kg/22lbs	13.3kg/29lbs	14kg/31lbs	14kg/30.9lbs	16kg/34lbs	20kg/44lbs
Net in kg/lbs	4.7kg/9lbs	8.4kg/18.5lbs	11.7kg/26lbs	12.4kg/27lbs	12.3kg/27lbs	14kg/29.6lbs	18kg/40.5lbs



# SPECIFICATIONS

Specifications	A2000	A3000	A4000	A5003	A6000
<b>RMS Power Output</b> 10Hz-20kHz into 2Ω, watts per channel into 4Ω, watts per channel into 8Ω, watts per channel	1200 watts 650 watts 350 watts	1600 watts 900 watts 500 watts	2000 watts 1000 watts 600 watts	2500 watts 1500 watts 900 watts	3000 watts 2000 watts 1200 watts
<b>No of Channels</b>	2	2	2	2	2
<b>Power Bandwidth</b> +0dB, - 3dB	2Hz-80kHz	2Hz-80kHz	2Hz-80kHz	2Hz-80kHz	2Hz-50kHz
<b>Slew Rate</b> in excess of	75V/μs	50V/μs	65V/μs	65V/μs	50V/μs
<b>Gain</b>	x 50	x 60	x 65	x 70	x 90
<b>Total Harmonic Distortion</b> Typical @ 1 dB below clip 20kHz @ 1dB below clip	0.04% 0.07%	0.04% 0.07%	0.04% 0.07%	0.04% 0.07%	0.04% 0.07%
<b>Signal to Noise Ratio</b> Typical ref. full output, unweighted Worst case 10Hz - 30kHz	-125dB -95dB	-125dB -95dB	-125dB -95dB	-125dB -95dB	-125dB -95dB
<b>Crosstalk</b> Typical Worst case 10Hz - 30kHz	-115dB -95dB	-115dB -95dB	-115dB -95dB	-115dB -95dB	-115dB -95dB
<b>Damping Factor</b>	400	400	400	400	400
<b>Input Impedance</b> electronically balanced	10k Ohm	10k Ohm	10k Ohm	10k Ohm	10k Ohm
<b>Common Mode Rejection</b> typically	-70dB	-70dB	-70dB	-70dB	-70dB
<b>Input Sensitivity</b> ref. full output into 4 ohms	IV RMS	IV RMS	IV RMS	IV RMS	IV RMS
<b>Protection</b> Clipping Load Below 1.2 ohms Shorted Output, DC or RF at output	Soft Dynamic linear Immediate	Soft Dynamic linear Immediate	Soft Dynamic linear Immediate	Soft Dynamic linear Immediate	Soft Dynamic linear Immediate
<b>Power Consumption</b>	3.9kVA	5.3kVA	6.6kVA	8kVA	5.3kVA per channel
<b>Power Requirements</b> 50/60Hz ac in volts Internally selectable for	220- 240v 100-120v	220- 240v 100-120v	220- 240v N/A	220- 240v N/A	220- 240v 100-120v
<b>Dimensions</b> Rack Units Height x Width x Depth in inches Height x Width x Depth in mm	2u 3.5 x 19 x 15 88 x 483 x 381	2u 3.5 x 19 x 15 88 x 483 x 381	3u 5.25 x 19 x 15 132 x 483 x 381	3u 5.25 x 19 x 15 132 x 483 x 381	4u 7 x 19 x 15 178 x 483 x 381
<b>Weight</b> Gross in kg/lbs Net in kg/lbs	13.3kg/29lbs 11.7kg/26lbs	14kg/31lbs 12.4kg/27lbs	16kg/34lbs 14kg/29.6lbs	16kg/34lbs 14kg/29.6lbs	23.5kg/59lbs 21.5kg/47.4lbs



# THE CHEVIN WARRANTY

This precision engineered CHEVIN product is guaranteed against defects due to faulty materials and workmanship for a period of 24 months from the date of the original purchase, subject to the following restrictions.

- ▶ This warranty is only valid in the country of purchase
- ▶ The equipment has not been abused or operated in conjunction with unsuitable or faulty apparatus.
- ▶ The equipment has not been disassembled, modified or tampered with by any person other than our CHEVIN staff or overseas by our own or distributors' staff.
- ▶ The equipment has not suffered damage in transit.

Should service be required, notify the dealer from whom you purchased the equipment to arrange for an authorised CHEVIN agent to confirm the need for attention.

- ▶ Do not dispatch the goods without the prior approval of CHEVIN or its authorised agents. If asked to return the goods, pack carefully (preferably in the original carton) and return pre-paid. Insurance is recommended as goods are returned at owner's risk.
- ▶ Packing insurance and freight on the return journey will be paid for by CHEVIN or its authorised agents only if warranty work proves necessary. If warranty work proves unnecessary, goods will be released upon payment by the owner for charges for non-warranty repair work and return packing, insurance and freight.
- ▶ The attached warranty card should be completed and returned to CHEVIN RESEARCH LTD. Failure to register by not returning the warranty card in no way limits or invalidates the warranty, but in the event of service being required, delay may result since warranty work cannot begin until the original sale has been verified.
- ▶ In case of difficulty, contact CHEVIN RESEARCH LTD. This warranty in no way affects your statutory rights.

**Head Office:** Chevin Research Ltd., 41a Ilkley Road, Otley, West Yorkshire LS21 3LP ENGLAND  
Tel: +44 (0)1943 466060 Fax: +44 (0)1943 466020  
[www.chevin-research.com](http://www.chevin-research.com)  
[sales@chevin-research.com](mailto:sales@chevin-research.com)

**Trademark Acknowledgements:** Speakon is a registered trademark of Neutrik AG  
XLR is a registered trademark of ITT Cannon Ltd.