

# 8085A

8-Bit Microprocessor

MILITARY INFORMATION

8085A

## DISTINCTIVE CHARACTERISTICS

- SMD/DESC qualified
- 3- and 5-MHz selections available
- On-chip system controller; advanced cycle status information available for large system control
- Four vectored interrupts (one is non-maskable)
- On-chip clock generator (with external crystal, LC or R/C network)
- Serial-in/serial-out port
- Decimal, binary, and double-precision arithmetic
- Direct addressing capability to 64K bytes of memory
- 1.3  $\mu$ s instruction cycle (8085A)
- 0.8  $\mu$ s instruction cycle (8085A-2)
- 100% software-compatible with 8080A
- Single +5 V power supply

## GENERAL DESCRIPTION

The 8085A is a new generation, complete 8-bit parallel central processing unit (CPU). Its instruction set is 100% software compatible with the 8080A microprocessor. Specifically, the 8085A incorporates all of the features that the 8224 (clock generator) and 8228 (system controller) provided for the 8080A. The 8085A-2 is a faster version of the 8085A. The 8085A is a 3-MHz CPU with 10% supply tolerances and lower power consumption.

The 8085A uses a multiplexed data bus. The address is split between the 8-bit address bus and the 8-bit data bus. The on-chip address latches of 8155H/56H memory products allow a direct interface with 8085A. The 8085A components, including various timing-compatible support chips, allow system speed optimization.

## BLOCK DIAGRAM

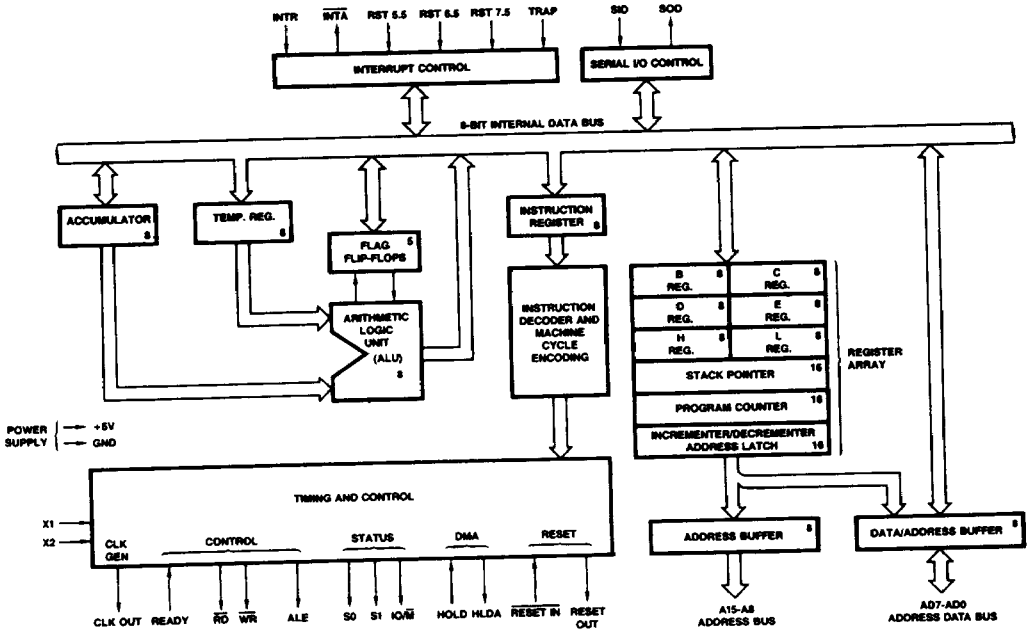

BD003790

Publication # Rev. Amendment  
09231 A /0  
Issue Date: November 1987

## CONNECTION DIAGRAM Top View DIPs

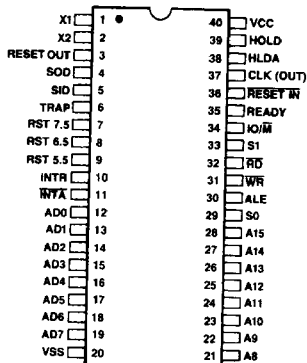

CD005564

Note: Pin 1 is marked for orientation.

### MILITARY ORDERING INFORMATION

#### Standard Military Drawing (SMD)/DESC Products

AMD products for Aerospace and Defense applications are available in several packages and operating ranges. Standard Military Drawing (SMD)/DESC products are fully compliant with MIL-STD-883C requirements. The order number (Valid Combination) for SMD/DESC products is formed by a combination of:

- a. **Military Drawing Part Number**
- b. **Device Type**
- c. **Case Outline**
- d. **Lead Finish**

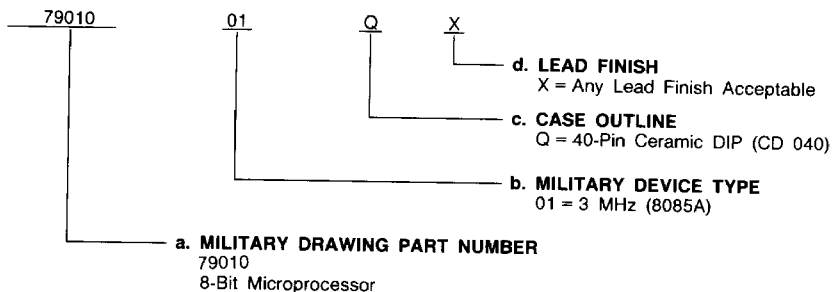

#### Valid Combinations

Valid Combinations	
7901001	QX

Valid Combinations list configurations planned to be supported in volume for this device. Consult the local AMD sales office to confirm availability of specific valid combinations or to check on newly released valid combinations.

#### Group A Tests

Group A tests consist of Subgroups  
1, 2, 3, 7, 8, 9, 10, 11.

# MILITARY ORDERING INFORMATION (Cont'd.)

## APL Products

AMD products for Aerospace and Defense applications are available in several packages and operating ranges. APL (Approved Products List) products are fully compliant with MIL-STD-883C requirements. The order number (Valid Combination) for APL products is formed by a combination of:

- a. **Device Number**
- b. **Speed Option** (if applicable)
- c. **Device Class**
- d. **Package Type**
- e. **Lead Finish**

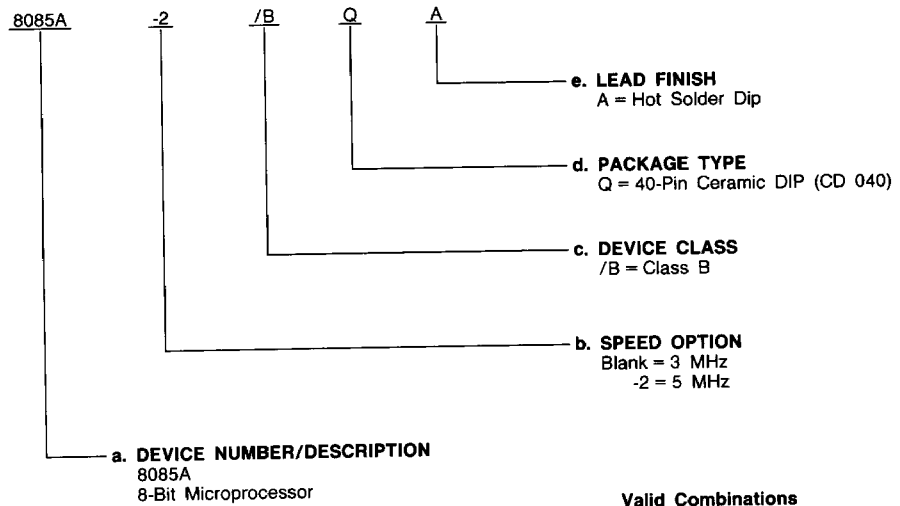

### Valid Combinations

Valid Combinations list configurations planned to be supported in volume for this device. Consult the local AMD sales office to confirm availability of specific valid combinations or to check for newly released valid combinations.

Valid Combinations	
8085A	/BQA
8085A-2	

### Group A Tests

Group A tests consist of Subgroups 1, 2, 3, 7, 8, 9, 10, 11.

**ABSOLUTE MAXIMUM RATINGS**

Storage Temperature ..... -65 to +150°C  
 Voltage on Any Pin  
 With Respect to Ground.....-0.5 to +7 V  
 Power Dissipation .....1.5 W

*Stresses above those listed under ABSOLUTE MAXIMUM RATINGS may cause permanent device failure. Functionality at or above these limits is not implied. Exposure to absolute maximum ratings for extended periods may affect device reliability.*

**OPERATING RANGES**

Military (M) Devices  
 Temperature (T<sub>C</sub>).....-55 to +125°C  
 Supply Voltage (V<sub>CC</sub>) .....5 V ±10%  
 Supply Current (I<sub>CC</sub>).....200 mA

*Operating ranges define those limits between which the functionality of the device is guaranteed.*

**DC CHARACTERISTICS** over operating range (for SMD/DESC and APL Products, Group A, Subgroups 1, 2, 3 are tested unless otherwise noted)

Parameter Symbol	Parameter Description	Test Conditions	Min.	Max.	Unit
V <sub>IL</sub>	Input LOW Voltage	V <sub>CC</sub> = 5 V ±10%	-0.5*	+0.8	V
V <sub>IH</sub>	Input HIGH Voltage	V <sub>CC</sub> = 5 V ±10%	2.2	V <sub>CC</sub> + 0.5*	V
V <sub>OL</sub>	Output LOW Voltage	I <sub>OL</sub> = 2 mA, V <sub>CC</sub> = 5 V ±10%		0.45	V
V <sub>OH</sub>	Output HIGH Voltage	I <sub>OH</sub> = -400 μA, V <sub>CC</sub> = 5 V ±10%	2.4		V
I <sub>CC</sub>	Power Supply Current	V <sub>CC</sub> = 5 V (Note 1)		200	mA
I <sub>IL1</sub>	Input Leakage, Except Pin 1	V <sub>CC</sub> = 5 V, V <sub>IN</sub> = V <sub>CC</sub> to 0 V		±10	μA
I <sub>IL2</sub>	Input Leakage, Pin 1	V <sub>CC</sub> = 5 V, V <sub>IN</sub> = V <sub>CC</sub> to 0 V		±70	μA
I <sub>LO</sub>	Output Leakage	V <sub>CC</sub> = 5.5 V, V <sub>OUT</sub> = V <sub>CC</sub> to .45 V		±10	μA
V <sub>ILR</sub>	Input LOW Level, RESET	V <sub>CC</sub> = 5 V ±10%	-0.5*	+0.8	V
V <sub>IHR</sub>	Input HIGH Level, RESET	V <sub>CC</sub> = 5 V ±10%	2.4	V <sub>CC</sub> + 0.5*	V
V <sub>HY</sub>	Hysteresis, RESET	V <sub>CC</sub> = 5 V ±10%	0.25		V

\*Guaranteed by design; not tested.

Notes: 1. I<sub>CC</sub> is measured while running a functional pattern with no loads applied.

**SWITCHING CHARACTERISTICS** over operating range (for SMD/DESC and APL Products, Group A, Subgroups 9, 10, 11 are tested unless otherwise noted)

Parameter Symbol	Parameter Description	8085A (Note 2)		8085A-2 (Note 2)		Unit
		Min.	Max.	Min.	Max.	
t <sub>CYC</sub>	CLK Cycle Period	320	2000	200	2000	ns
t <sub>1</sub>	CLK LOW Time (Standard CLK Loading)	80		40		ns
t <sub>2</sub>	CLK HIGH Time (Standard CLK Loading)	120		70		ns
t <sub>r</sub> , t <sub>f</sub>	CLK Rise and Fall Time		30		30	ns
t <sub>XKR</sub>	X <sub>1</sub> Rising to CLK Rising	20	120	20	100	ns
t <sub>XKF</sub>	X <sub>1</sub> Rising to CLK Falling	20	150	20	110	ns
t <sub>AC</sub>	A <sub>8-15</sub> Valid to Leading Edge of Control (Note 1)	270		115		ns
t <sub>ACL</sub>	A <sub>0-7</sub> Valid to Leading Edge of Control	240		115		ns
t <sub>AD</sub>	A <sub>0-15</sub> Valid to Valid Data In		575		350	ns
t <sub>AFR</sub>	Address Float After Leading Edge of READ (INTA)		0		0	ns
t <sub>AL</sub>	A <sub>8-15</sub> Valid Before Trailing Edge of ALE (Note 1)	90		50		ns
t <sub>ALL</sub>	A <sub>0-7</sub> Valid Before Trailing Edge of ALE	70		50		ns
t <sub>ARY</sub>	READY Valid from Address Valid		220		100	ns
t <sub>CA</sub>	Address (A <sub>8-15</sub> ) Valid After Control	120		50		ns
t <sub>CC</sub>	Width of Control LOW (RD, WR, INTA) Edge of ALE	400		230		ns
t <sub>CL</sub>	Trailing Edge of Control to Leading Edge of ALE	50		25		ns
t <sub>DW</sub>	Data Valid to Trailing Edge of WRITE	420		230		ns
t <sub>HABE</sub>	HLDA to Bus Enable		210		150	ns
t <sub>HABF</sub>	Bus Float After HLDA		210		150	ns
t <sub>HACK</sub>	HLDA Valid to Trailing Edge of CLK	110		40		ns
t <sub>HDH</sub>	HOLD Hold Time	0		0		ns
t <sub>HDS</sub>	HOLD Setup Time to Trailing Edge of CLK	170		120		ns
t <sub>INH</sub>	INTR Hold Time	0		0		ns
t <sub>INS</sub>	INTR, RST, and TRAP Setup Time to Falling Edge of CLK	160		150		ns
t <sub>LA</sub>	Address Hold Time After ALE	100		50		ns
t <sub>LC</sub>	Trailing Edge of ALE to Trailing Edge of Control	130		60		ns
t <sub>LCK</sub>	ALE LOW During CLK HIGH	100		50		ns
t <sub>LDR</sub>	ALE to Valid Data During Read		460		270	ns
t <sub>LDW</sub>	ALE to Valid Data During Write		200		120	ns
t <sub>LL</sub>	ALE Width	140		80		ns
t <sub>LRY</sub>	ALE to READY Stable		110		30	ns
t <sub>RAE</sub>	Trailing Edge of READ to Re-Enabling of Address	150		90		ns
t <sub>RD</sub>	READ (or INTA) to Valid Data		300		150	ns
t <sub>RV</sub>	Control Trailing Edge to Leading Edge of Next Control	400		220		ns
t <sub>RDH</sub>	Data Hold Time After READ INTA (Note 6)	0		0		ns
t <sub>RYH</sub>	READY Hold Time	0		0		ns
t <sub>RYS</sub>	READY Setup Time to Leading Edge of CLK	110		100		ns
t <sub>DW</sub>	Data Valid After Trailing Edge of WRITE	100		60		ns
t <sub>WDL</sub>	LEADING Edge of WRITE to Data Valid		40		20	ns

- Notes: 1. A<sub>8</sub> - A<sub>15</sub> address Specs apply to IO/M, S<sub>0</sub>, and S<sub>1</sub>, except A<sub>8</sub> - A<sub>15</sub> are undefined during T<sub>4</sub> - T<sub>6</sub> of OF cycle; whereas, IO/M, S<sub>0</sub>, and S<sub>1</sub> are stable.
2. Test conditions: t<sub>CYC</sub> = 320 ns (8085A)/200 ns (8085A-2); C<sub>L</sub> = 100 pF, V<sub>CC</sub> = 5 V ± 10%, V<sub>IL</sub> = .45 V, V<sub>IH</sub> = 2.4 V; V<sub>OL</sub> = .8 V, V<sub>OH</sub> = 2.0 V.
3. For all output timing where C<sub>L</sub> = 150 pF use the following correction factors:  
 25 pF ≤ C<sub>L</sub> < 150 pF: -0.10 ns/pF  
 150 pF < C<sub>L</sub> ≤ 300 pF: +0.30 ns/pF
4. Output timings are measured with purely capacitive load.
5. To calculate timing specifications at other values of t<sub>CYC</sub> use Table 3 on page 3-191 of the MOS Microprocessors and Peripherals Data Book (Order #09067A)
6. Data hold time is guaranteed under all loading conditions.

CHAPTER 6

General Information



T-90-20

PACKAGE OUTLINES\*

Ceramic DIPs (CD)

CD 024

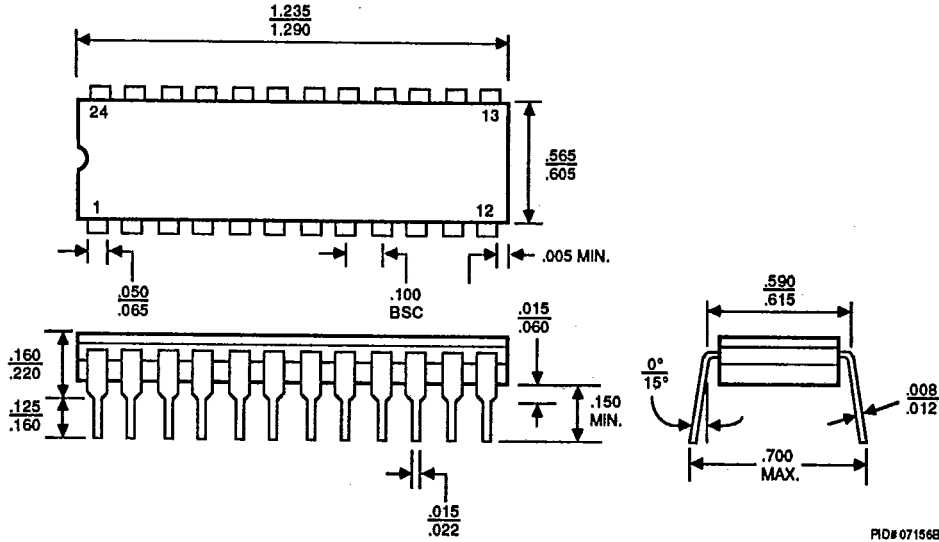

PID# 071568

CD 028

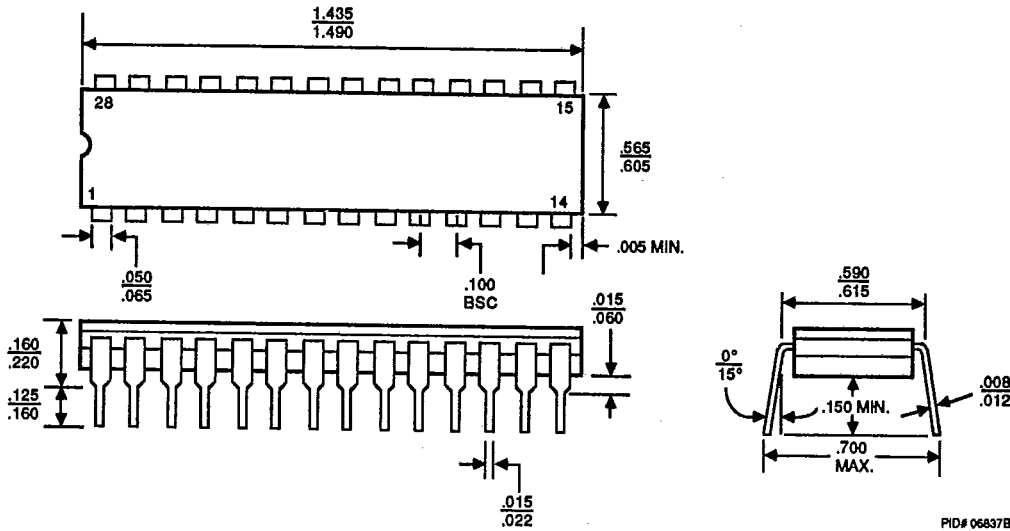

PID# 068378

\* For reference only.

NOTE: Package dimensions are given in inches. To convert to millimeters, multiply by 25.4.

PACKAGE OUTLINES (Continued)

Ceramic DIPs (CD) (Continued)

CD 040

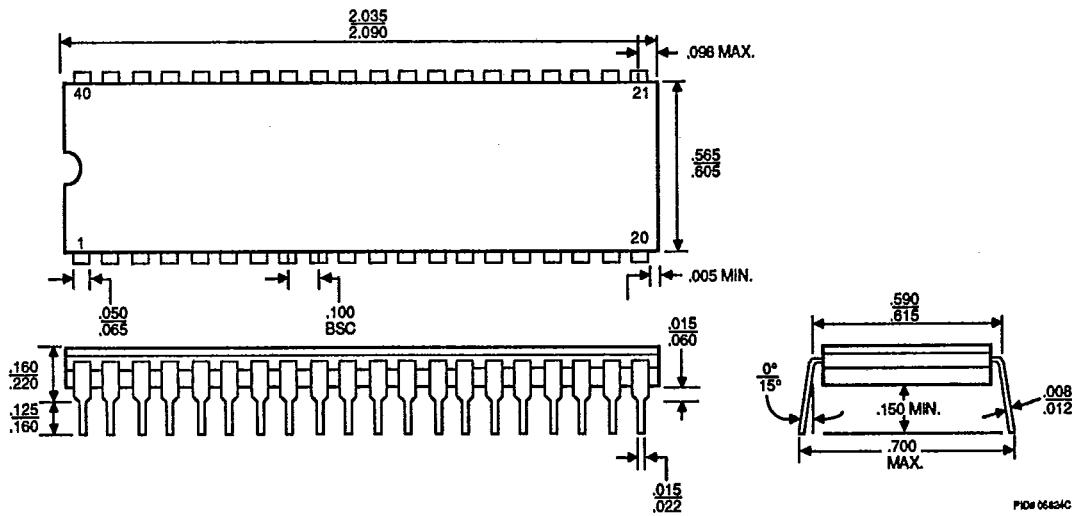

CDV040

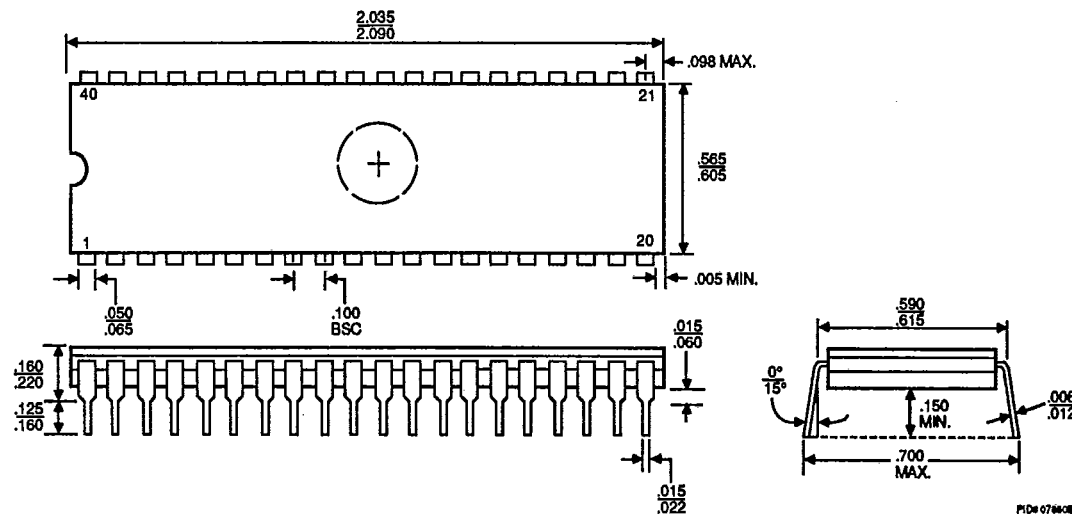

NOTE: Package dimensions are given in inches. To convert to millimeters, multiply by 25.4.

PACKAGE OUTLINES (Continued)

T-90-20

Ceramic Sidebrazed DIPs (SD)  
SD 040

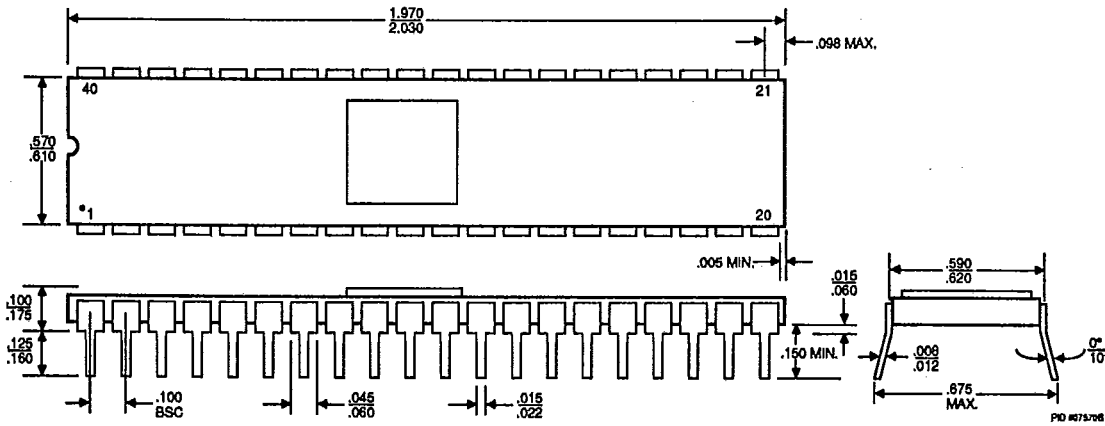

SD 048

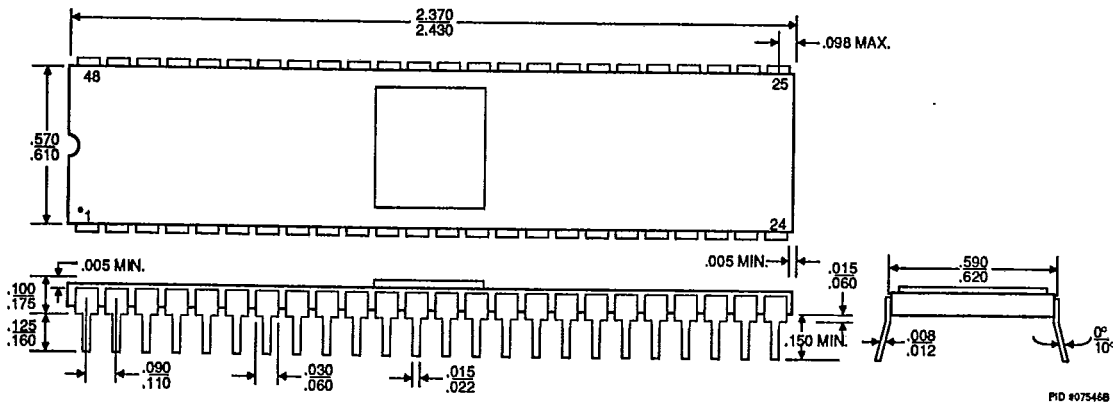

NOTE: Package dimensions are given in inches. To convert to millimeters, multiply by 25.4.



**PACKAGE OUTLINES (Continued)**  
**Ceramic Leadless Chip Carriers (CL/CLV)**  
**CL 044**

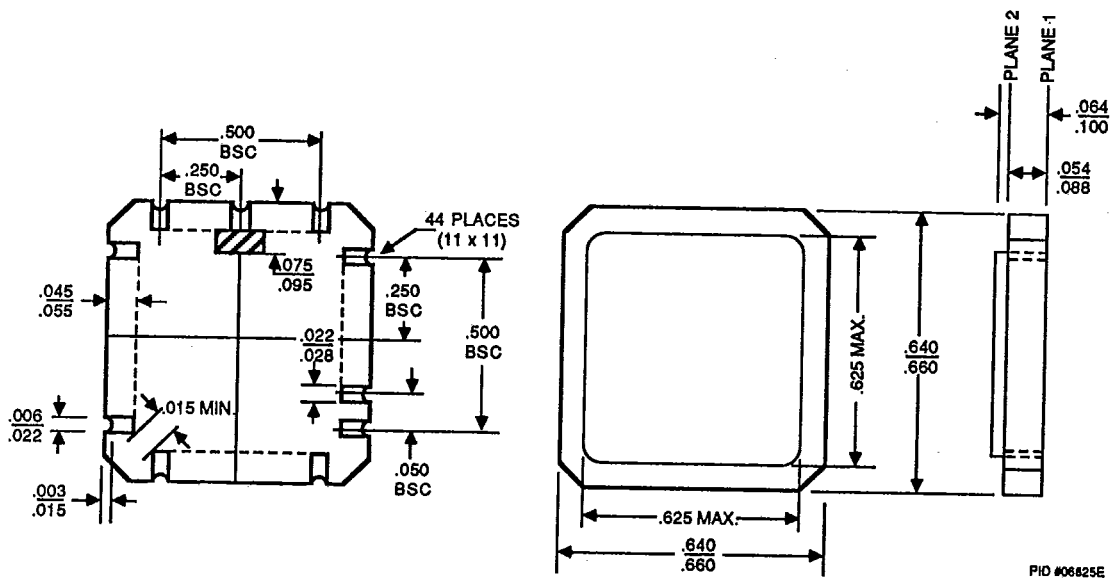

PID #06825E

**CLV044**

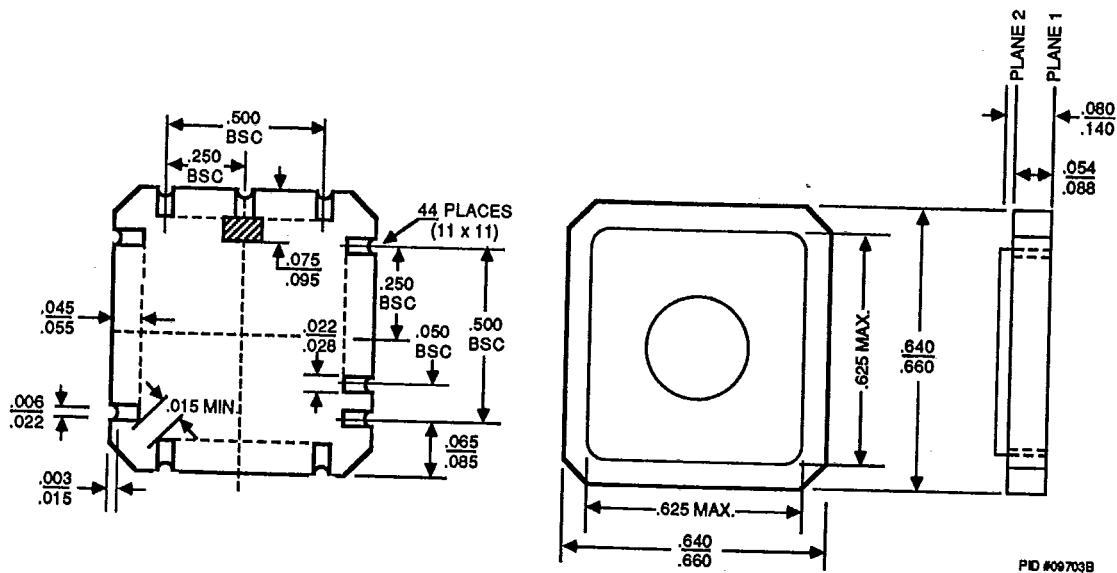

PID #09703B

NOTE: Package dimensions are given in inches. To convert to millimeters, multiply by 25.4.

**PACKAGE OUTLINES (Continued)**  
**68-Pin Square Leadless Chip Carrier (CA2)**  
**CA2068**

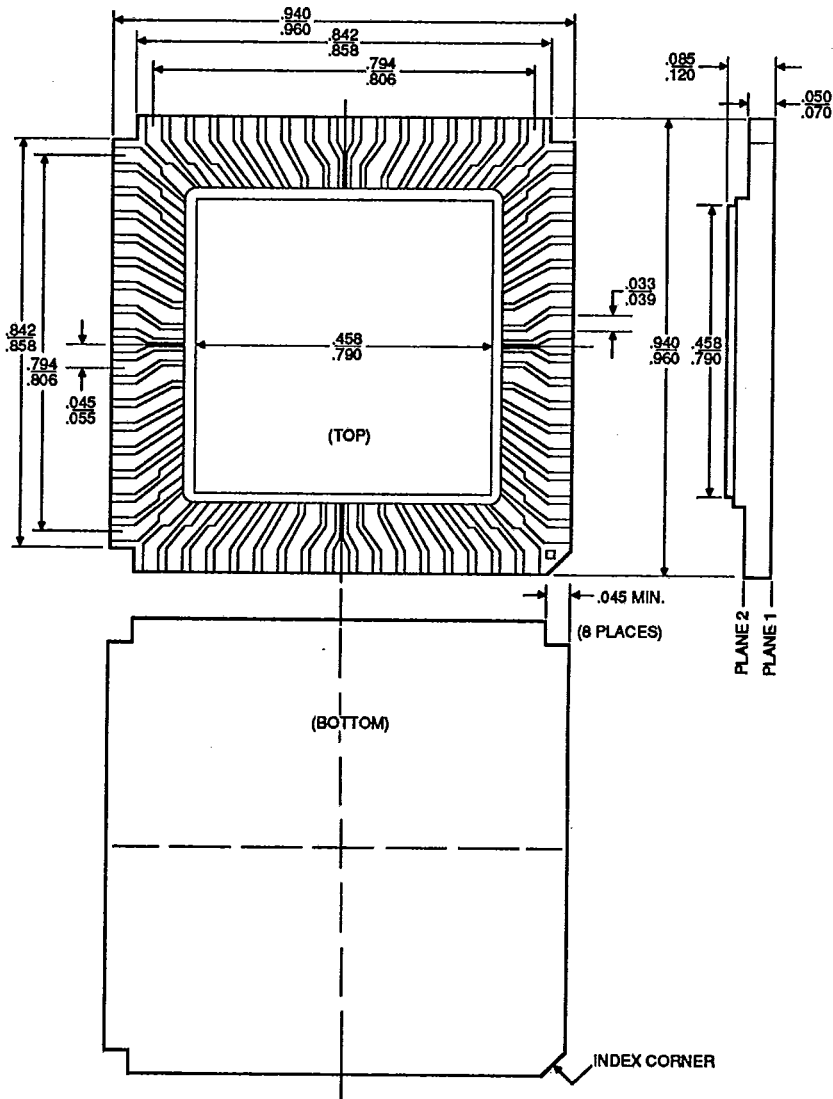

PID #07267B

NOTE: Package dimensions are given in inches. To convert to millimeters, multiply by 25.4.

**PACKAGE OUTLINES (Continued)**  
**Ceramic Pin-Grid-Array Package (CG/CGX)**  
**CGX068**

**BOTTOM VIEW**

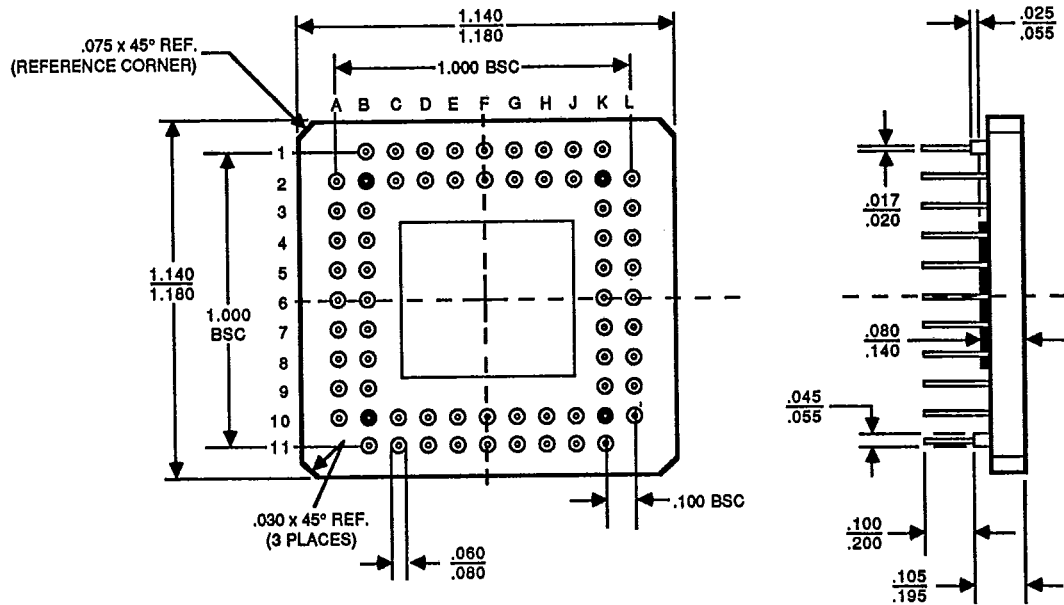

PID # 07547B

NOTE: Package dimensions are given in inches. To convert to millimeters, multiply by 25.4.