



www.dataSheet4U.com

## ANDpSi089C362S-KIT

### 8.90" WSVGA Color p-Si TFT LCD Module

The ANDpSi089C362S is 1024 x 600 Color TFT display that utilizes new poly-silicon (p-Si) technology to provide a brighter, thinner and lighter display with high-resolution. The p-Si TFT technology allows the row and column LCD drivers to be fabricated directly on the LCD glass. This eliminates the need for discrete TAB drivers and also reduces the thickness, weight and overall size of the display. The 8.90" WSVGA resolution expands applications in mini-notebook PC's.

#### Features

• RoHS Compliant

- High Luminance
- Single CCFL, Sidelight type
- Replaceable structure of lamp units
- LVDS interface system
- Slim (5.2mmMAX)
- WSVGA (1024 x 600 pixels color display)
- Applications: 8.9" wide display size for notebook PC

#### Mechanical Characteristics

Item	Specification	Unit
Dimensional Outline (Typ.)	224.0(W) x 129.0 (H) x 5.2 max(D)	mm
Number of Pixels	1024(W) x 600(H)	pixels
Active Area	195.07 (W) x 113.40 (H)	mm
Pixel Pitch	0.1905 (W) x 0.1890 (H)	mm
Weight (approx.)	160	gram
Backlight	Single CCFL, Sidelight type	-

#### Absolute Maximum Ratings

Item	Min.	Max.	Unit	
Supply Voltage	$V_{DD}$	-0.3	+4.0	V
	$V_{FL}$	-	2.0	kV(rms)
FL Driving Frequency	$f_{FL}$	-	100	kHz
Input Signal Voltage	$V_{IN}$	-0.3	$V_{DD} + 0.3$	%(RH)
Operating Temperature		0	50	°C
Storage Temperature		-20	60	°C
Storage Humidity		10	90	%(RH)

#### Electrical Characteristics (Ta = 25°C)

Item	Symbol	Min.	Typ.	Max.	Unit
Supply Voltage $I_{FL}=3.0\text{mA(rms)}$	$(V_{DD})$	3.0	3.3	3.6	V
	$(V_{FL})$	450	500	550	V(rms)
FL Start Voltage (Ta = 0°C)	-	1300	-	-	V(rms)
Differential Input Voltage	$(V_{ID})$	100	-	500	mV
Common Mode Input Voltage	$(V_{CM})$	1.0	-	2.4 - $V_{ID}/2$	V
Current Consumption	*1( $I_{DD}$ )	-	180	250	mA
	*2( $I_{FL}$ )	3.0	5.5	6.0	mA(rms)
*1 *2 Power Consumption $I_{FL}=5.5\text{mA(rms)}$	-	-	3.4	-	W

\*1) 8 color bars pattern

\*2) Excepting the efficiency FL inverter

#### Optical Characteristics (Ta = 25°C)

Item	Min.	Typ.	Max.	Unit	
Contrast Ratio (CR)	100	-	-	-	
Response Time	$(t_{ON})$	-	-	50	ms
	$(t_{OFF})$	-	-	50	ms
Luminance (L) $I_{FL}=3.0\text{mA(rms)}$	175	250	-	cd/m <sup>2</sup>	

Product specifications contained herein may be changed without prior notice.

It is therefore advisable to contact Purdy Electronics before proceeding with the design of equipment incorporating this product.

### Dimensional Outline

Front View

Unit: mm  
Standard Tolerance: 0.5mm

www.datasheet4u.com

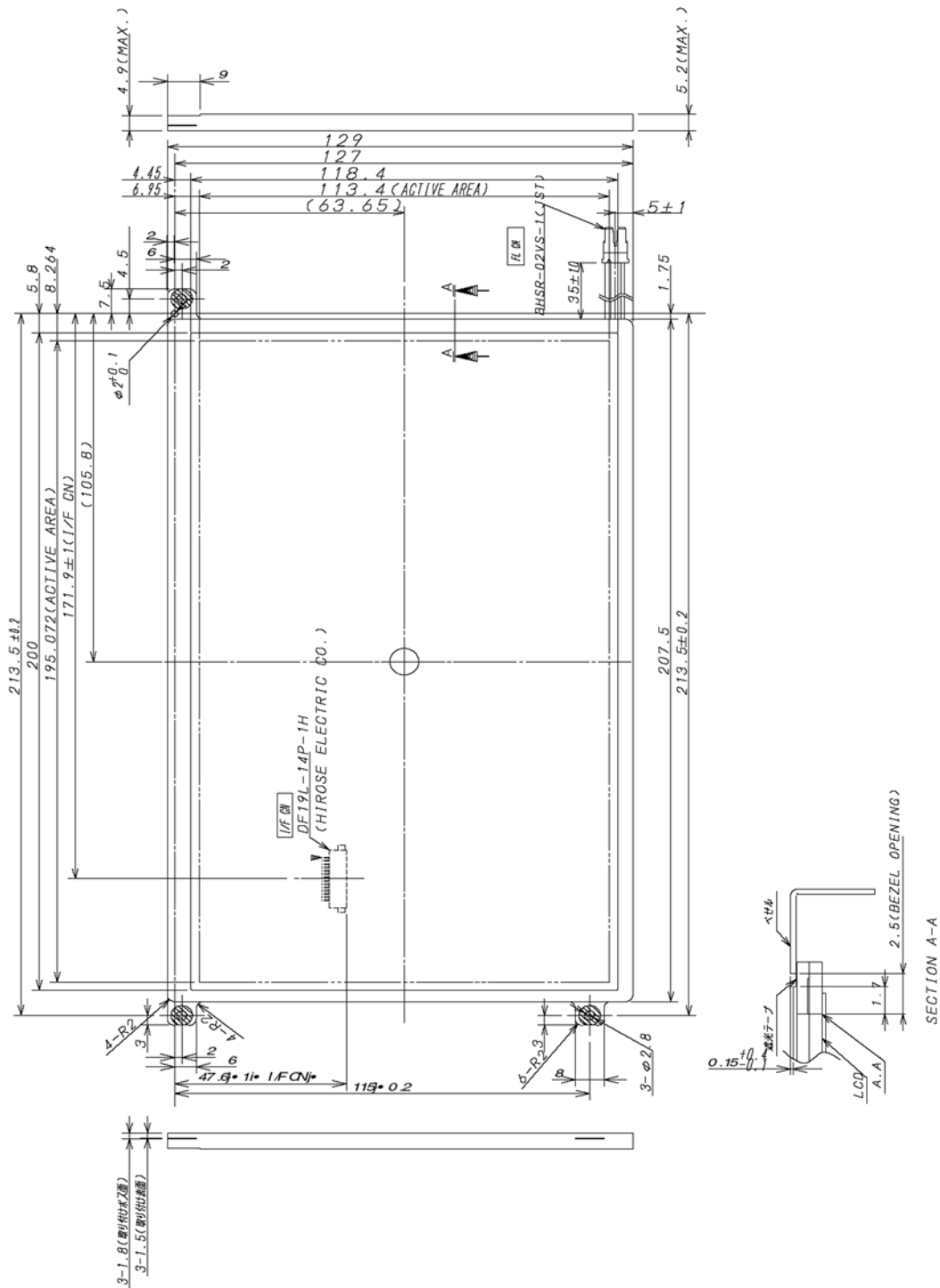

**Dimensional Outline**

**Back View**

Unit: mm  
Standard Tolerance: 0.5mm

www.datasheet4u.com

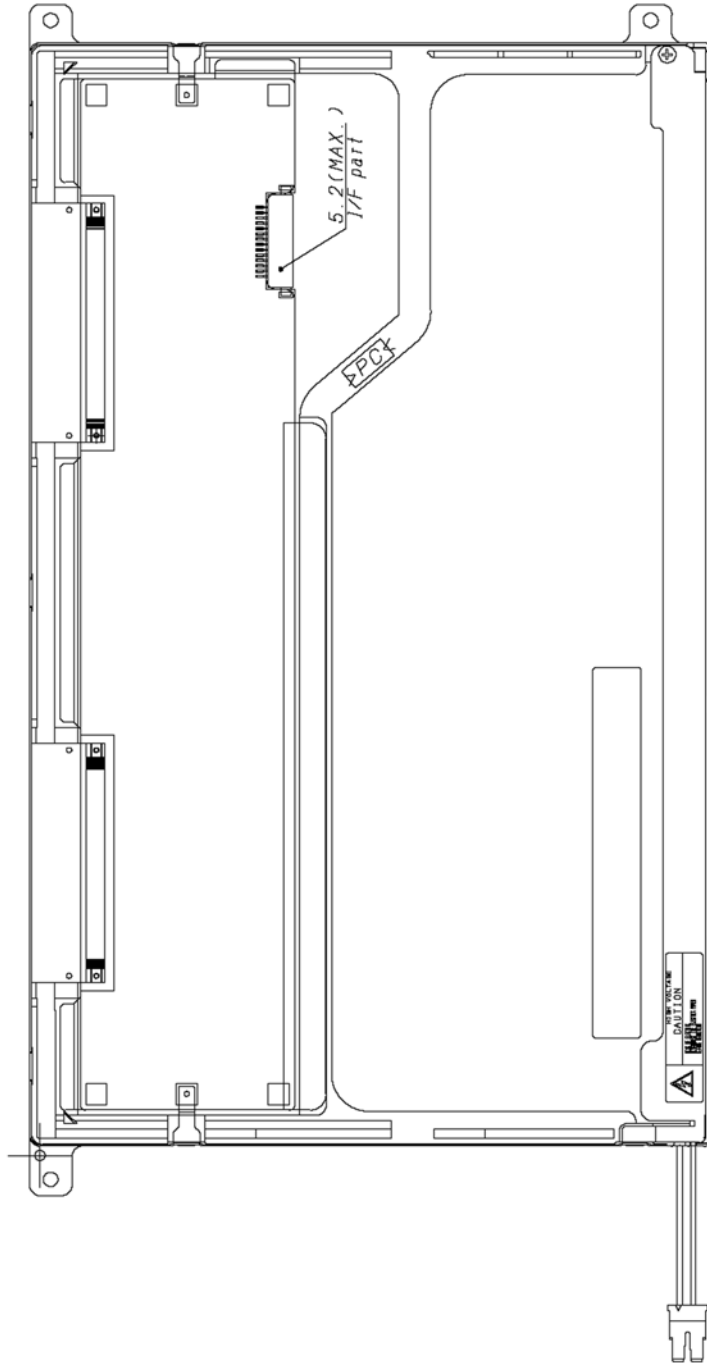

**Timing Specifications** (see Notes below)

Signal	Item	Symbol	Min	Typ	Max	Unit
NCLK	Frame Period	$t_s$	19.0	19.84	–	ns
	Frequency	$1/t_s$	–	50.4	52.6	MHz
	high Time	$t_{sh}$	6	–	–	ns
	Low Time	$t_{sl}$	7	–	–	ns
HSYNC	Setup to NCLK	$t_{ts}$	7	–	–	ns
	Pulse Width	$t_{lw}$	$8 \times t_s$	–	–	–
VSYNC	Pulse Width	$t_{fw}$	$3 \times t_{lpd}$	–	$7 \times t_{lpd}$	–
	VSYNC to DATA	$t_{fd}$	$7 \times t_{lpd}$	–	–	–
	Setup to HSYNC	$t_{fl}$	16	–	–	ns
–	Line Period	$t_{lpd}=t_{lpl}$	$1320 \times t_s$ 25.08	$1344 \times t_s$ 26.67	$1344 \times t_s$	– $\mu s$
	Horizontal Display Time	$t_{hd}$	$1024 \times t_s$	$1024 \times t_s$	$1024 \times t_s$	–
–	Frame Frequency	$1/t_{fpd}$	56	60	–	Hz
	Frame Period	$t_{fpd}=t_{fpl}$	$610 \times t_{lpd}$	$625 \times t_{lpd}$	$635 \times t_{lpd}$	–
	Vertical Display Time	$t_{vd}$	$600 \times t_{lpd}$	$600 \times t_{lpd}$	$600 \times t_{lpd}$	–
DATA	Setup	$t_{ds}$	5	–	–	ns
	Hold	$t_{dh}$	7	–	–	ns
DE	Setup	$t_{drs}$	10	–	–	ns
	Hold	$t_{drh}$	10	–	–	ns
	Display Start	$t_{drds}$	–	–	$400 \times t_s$	–

**Notes:**

Refer to "Timing Chart" below. If NCLK is fixed to "H" or "L" level for certain period while VDD is supplied, the panel may be damaged. Please adjust LCD operating signal timing and FL driving frequency, to optimized the display quality. There is a possibility that flicker is observed by the interference of LCD operating signal firing and FL driving condition (especially driving frequency), even if the condition satisfied above timing specifications. Do not make  $t_v$ ,  $t_{vhd}$  and  $t_{vds}$  fluctuate. If  $t_v$ ,  $t_{vhd}$ , and  $t_{vds}$  are fluctuating, the panel displays black. In case of using the long frame period, the deterioration of display quality, noise, etc., may be occurring. NCLK count of each Horizontal Scanning Time should always be the same. V-Blanking period should be " $n$ " X "Horizontal Scanning Time". ( $n$ :integer) Frame period should always be the same.

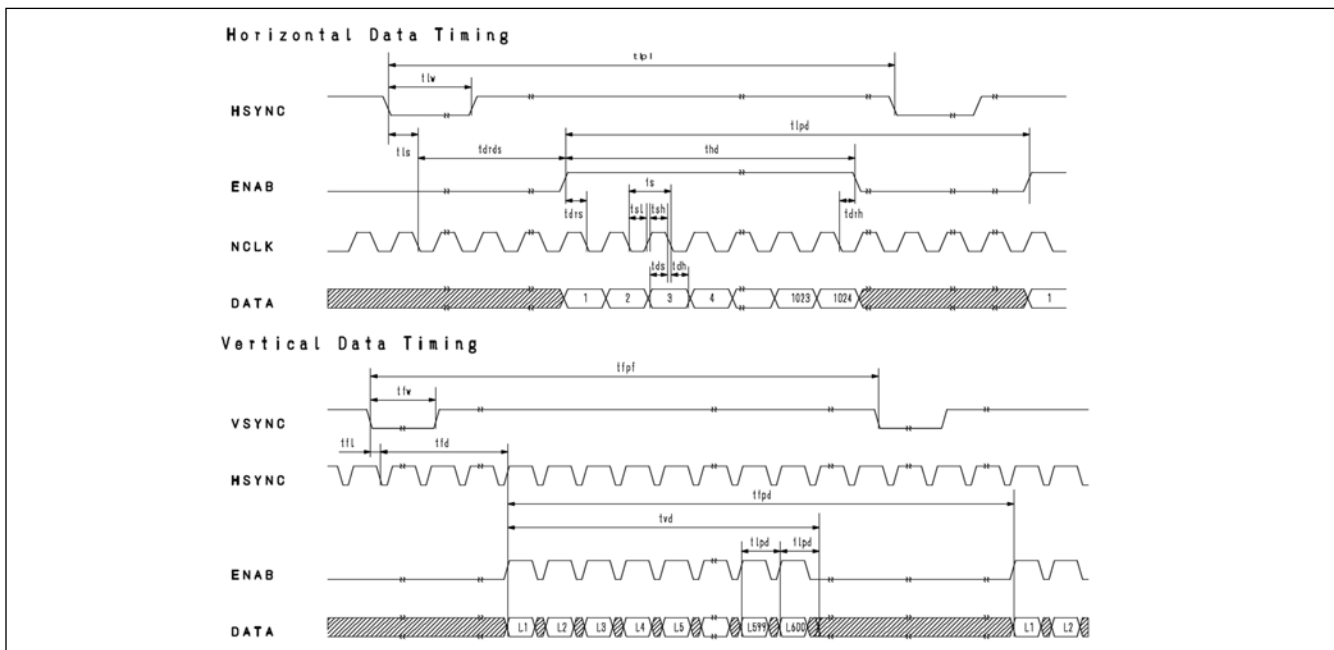
**Timing Chart**

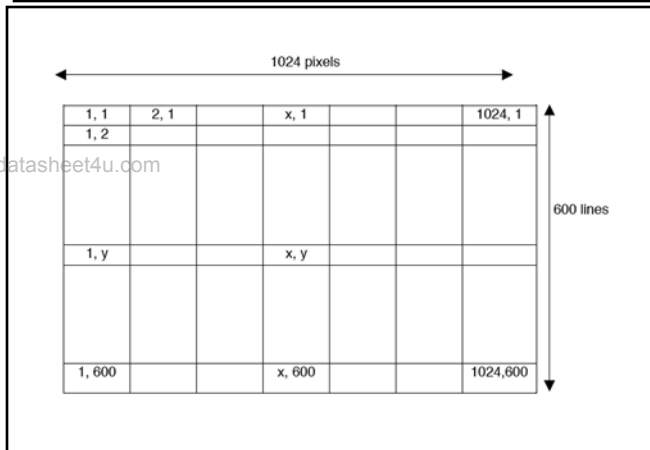

www.datasheet4u.com

### Block Diagram

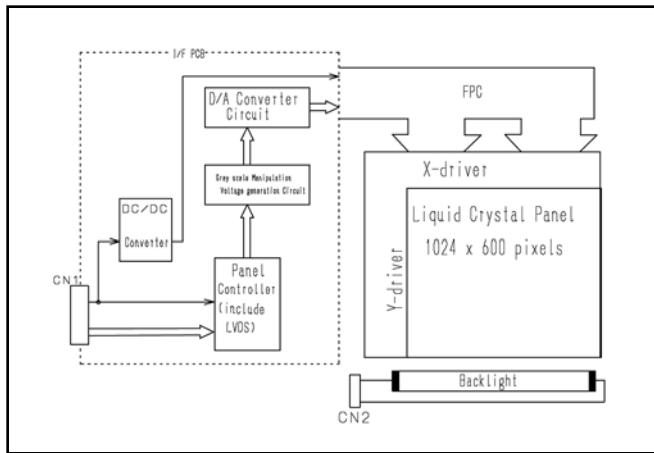

### Connector Pin Assignment for Interface

#### CN1 Input Signal

Connector: DF19L-14P-1H / Hirose

Matching Connector: DF19G-14S-1C / Hirose

Terminal No.	Symbol	Function
1	V <sub>DD</sub>	Power Supply Voltage; +3.3V
2	V <sub>DD</sub>	Power Supply Voltage; +3.3V
3	GND	GND
4	GND	GND
5	RxIN0-	Negative LVDS differential clock input (R0-R5, G0)
6	RxIN0+	Positive LVDS differential clock input (R0-R5, G0)
7	RxIN1-	Negative LVDS differential clock input (G1-G5, B0-B1)
8	RxIN1+	Positive LVDS differential clock input (G1-G5, B0-B1)
9	RxIN2-	Negative LVDS differential clock input (B2-B5, HS, VS, DE)
10	RxIN2+	Positive LVDS differential clock input (B2-B5, HS, VS, DE)
11	CLK-	Clock Signal (-)
12	CLK+	Clock Signal (+)
13	GND	GND
14	GND	GND

Note: Please connect GND pin to ground. Don't use it as no-connect nor connection with high impedance.

#### CN2 CCFL Power Source

Connector: BHSR-02VS-1 / Japan Solderless Terminal Mfg. Co., Ltd.

Matching Connector: SM02B-BHSS-1 / Japan Solderless Terminal Mfg. Co., Ltd.

Terminal No.	Symbol	Function
1	V <sub>FLH</sub>	CCFL Power Supply (High Voltage)
2	V <sub>FLL</sub>	CCFL Power Supply (Low Voltage)

**256k (k+1024) Colors Combination Table**

	Display	R5	R4	R3	R2	R1	R0	G5	G4	G3	G2	G1	G0	B5	B4	B3	B2	B1	B0	Gray Scale Level
Basic Color	Black	L	L	L	L	L	L	L	L	L	L	L	L	L	L	L	L	L	L	-
	Blue	L	L	L	L	L	L	L	L	L	L	L	L	H	H	H	H	H	H	-
	Green	L	L	L	L	L	L	H	H	H	H	H	H	L	L	L	L	L	L	-
	Lt. Blue	L	L	L	L	L	L	H	H	H	H	H	H	H	H	H	H	H	H	-
	Red	H	H	H	H	H	H	L	L	L	L	L	L	L	L	L	L	L	L	-
	Purple	H	H	H	H	H	H	L	L	L	L	L	L	H	H	H	H	H	H	-
	Yellow	H	H	H	H	H	H	H	H	H	H	H	H	L	L	L	L	L	L	-
	White	H	H	H	H	H	H	H	H	H	H	H	H	H	H	H	H	H	H	-
Gray Scale of Red	Black	L	L	L	L	L	L	L	L	L	L	L	L	L	L	L	L	L	L	L0
	Dark	L	L	L	L	L	H	L	L	L	L	L	L	L	L	L	L	L	L	L1
		L	L	L	L	H	L	L	L	L	L	L	L	L	L	L	L	L	L	L2
	↕	:						:						:						L3~L60
		:						:						:						
	Light	H	H	H	H	L	H	L	L	L	L	L	L	L	L	L	L	L	L	L61
		H	H	H	H	H	L	L	L	L	L	L	L	L	L	L	L	L	L	L62
	Red	H	H	H	H	H	H	L	L	L	L	L	L	L	L	L	L	L	L	Red L63
Gray Scale of Green	Black	L	L	L	L	L	L	L	L	L	L	L	L	L	L	L	L	L	L	L0
	Dark	L	L	L	L	L	L	L	L	L	L	L	H	L	L	L	L	L	L	L1
		L	L	L	L	L	L	L	L	L	L	H	L	L	L	L	L	L	L	L2
	↕	:						:						:						L3~L60
		:						:						:						
	Light	L	L	L	L	L	L	H	H	H	H	L	H	L	L	L	L	L	L	L61
		L	L	L	L	L	L	H	H	H	H	H	L	L	L	L	L	L	L	L62
	Green	L	L	L	L	L	L	H	H	H	H	H	H	L	L	L	L	L	L	Green L63
Gray Scale of Blue	Black	L	L	L	L	L	L	L	L	L	L	L	L	L	L	L	L	L	L	L0
	Dark	L	L	L	L	L	L	L	L	L	L	L	L	L	L	L	L	L	H	L1
		L	L	L	L	L	L	L	L	L	L	L	L	L	L	L	L	H	L	L2
	↕	:						:						:						L3~L60
		:						:						:						
	Light	L	L	L	L	L	L	L	L	L	L	L	L	H	H	H	H	L	H	L61
		L	L	L	L	L	L	L	L	L	L	L	L	H	H	H	H	H	L	L62
	Blue	L	L	L	L	L	L	L	L	L	L	L	L	H	H	H	H	H	H	Blue L63
Gray Scale of White & Black	Black	L	L	L	L	L	L	L	L	L	L	L	L	L	L	L	L	L	L	L0
	Dark	L	L	L	L	L	H	L	L	L	L	L	H	L	L	L	L	L	H	L1
		L	L	L	L	H	L	L	L	L	L	H	L	L	L	L	L	H	L	L2
	↕	:						:						:						L3~L60
		:						:						:						
	Light	H	H	H	H	L	H	H	H	H	H	L	H	H	H	H	H	L	H	L61
		H	H	H	H	H	L	H	H	H	H	H	L	H	H	H	H	H	L	L62
	White	H	H	H	H	H	H	H	H	H	H	H	H	H	H	H	H	H	H	White L63

# PC-TFT-104

## Features

www.datasheet4u.com

- **RoHS Compliant**
- Used for AND-TFT-LCD displays
- Input power: +12V DC
- Input Source: VGA (640 x 480) & NTSC Composite
- Operating Temperature: 0 °C ~ 60 °C
- Storage Temperature: -20 °C ~ 70 °C

PC-TFT-104 has universal LVDS interface for 5.6", 8.4", 10.4" and 12.1" displays. All these displays are well suitable for security systems, video games, door phones, video phones and portable TVs as well as industrial display applications.

## Electrical Characteristics

Symbol	I/O	Conditions	Min.	Typ.	Max.	Unit
$V_{IN}$	I	DC (+)	10	12	14	V
$I_{IN}$		DC (+12V)	1.02	1.05	1.08	A
$P_{IN}$			12.24	12.60	12.96	W

## CON 1: External Signal Input Terminal (14 pin) - MOLEX 53261-1471 or Compatible

Pin No.	Symbol	I/O	Conditions
1	Vin	Input	Vin
2	GND	Input	Ground
3	GND	Input	Ground
4	AV1	Input	Composite Video 1
5	NC	Input	No Connect
6	AV2	Input	Compiste Video 2
7	GND	Input	Ground
8	R	Input	VGA Red Signal Input
9	G	Input	VGA Green Signal Input
10	B	Input	VGA Blue Signal Input
11	GND	Input	Ground
12	H-SYNC	Input	HSYNC Input for VGA
13	V-SYNC	Input	VSYNC Input for VGA
14	GND	Input	Ground

**CON2: Connector for Keypad (10 pin) - Type: MOLEX 53261-1071 or Compatible**

Pin	Definition	Pin	Description	Pin	Description
1	LED-RED	5	+3.3 V	9	UP
2	LED-GREEN	6	POWER	10	ENTER
3	SENSOR	7	MENU		
4	GND	8	DOWN		

**CON4: Connector for LCD Module (LVDS/34 pin) - Type: MOLEX 87758-34 or Compatible**

Pin	Symbol	Description	Pin	Symbol	Description
1	IN0-	LVDS Transceiver Signal Channel 0	18	NC	No Connection
2	IN0+	LVDS Transceiver Signal Channel 0	19	NC	No Connection
3	IN1-	LVDS Transceiver Signal Channel 1	20	NC	No Connection
4	IN1+	LVDS Transceiver Signal Channel 1	21	NC	No Connection
5	IN2-	LVDS Transceiver Signal Channel 2	22	NC	No Connection
6	IN2+	LVDS Transceiver Signal Channel 2	23	NC	No Connection
7	GND	Ground	24	GND	Ground
8	CLK-	LVDS Transceiver Signal Clock	25	GND	Ground
9	CLK+	LVDS Transceiver Signal Clock	26	GND	Ground
10	NC	No Connection	27	GND	Ground
11	NC	No Connection	28	VCC	+3.3V Power Supply
12	NC	No Connection	29	VCC	+3.3V Power Supply
13	NC	No Connection	30	VCC	+3.3V Power Supply
14	GND	Ground	31	VCC	+3.3V Power Supply
15	NC	No Connection	32	VCC	+3.3V Power Supply
16	NC	No Connection	33	NC	No Connection
17	GND	Ground	34	NC	No Connection

**CON6: Connector for LCD Backlight Driver Board (4 pin) - Type: JST B4B-XH-A or Compatible**

Pin	Definition	Pin	Description	Pin	Description	Pin	Definition
1	+12V	2	GND	3	ON/OFF*	4	NC

\* Backlight control switch (ON: 5V, OFF: 0V)



Outline Dimension

www.datasheet4u.com

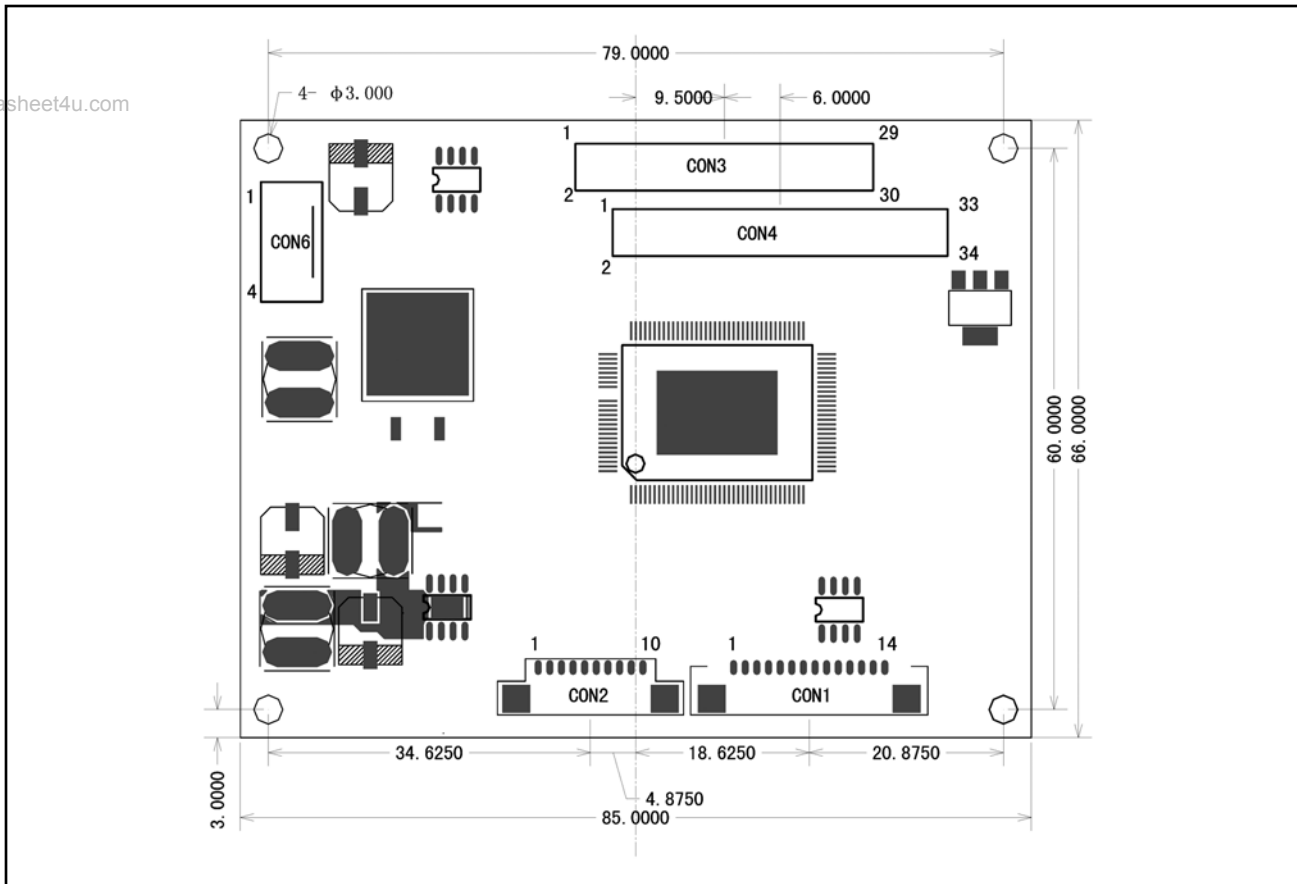

**Description:**

**Outline:** 85.0 x 66.0 x 10.1 mm

**Top Layer Height (Max):** 7.0 mm









**Bottom Layer Height (Max):** 1.9 mm

**Board Thickness:** 1.2 mm

**Screws:** φ 3.0 mm x 4

### Outline Dimension

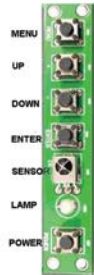
www.datasheet4u.com

<b>A</b>	DRIVER BOARD		Cable for DEMO KIT	Panel Cable	B/L DRIVER BOARD	B/L D/B Cable
				 Note2		
<b>B</b> Note1	DEMO KIT	KEYBOARD	Cable for KEYBOARD		Remote Control	
						

Note1: The parts in Column B are optional.

Note2: There is a white dot on the panel cable to indicate Pin1, and this pin is connected to Pin1 of Driver Board. See following picture:

