

AMD Athlon™ XP Processor Model 8 Data Sheet

DataShee

DataSheet4U.com



Preliminary Information

© 2001–2003 Advanced Micro Devices, Inc. All rights reserved.

The contents of this document are provided in connection with Advanced Micro Devices, Inc. (“AMD”) products. AMD makes no representations or warranties with respect to the accuracy or completeness of the contents of this publication and reserves the right to make changes to specifications and product descriptions at any time without notice. No license, whether express, implied, arising by estoppel or otherwise, to any intellectual property rights is granted by this publication. Except as set forth in AMD’s Standard Terms and Conditions of Sale, AMD assumes no liability whatsoever, and disclaims any express or implied warranty, relating to its products including, but not limited to, the implied warranty of merchantability, fitness for a particular purpose, or infringement of any intellectual property right.

AMD’s products are not designed, intended, authorized or warranted for use as components in systems intended for surgical implant into the body, or in other applications intended to support or sustain life, or in any other application in which the failure of AMD’s product could create a situation where personal injury, death, or severe property or environmental damage may occur. AMD reserves the right to discontinue or make changes to its products at any time without notice.

Trademarks

AMD, the AMD Arrow logo, AMD Athlon, AMD Duron, and combinations thereof, QuantiSpeed, and 3DNow! are trademarks of Advanced Micro Devices, Inc.

HyperTransport is a licensed trademark of the HyperTransport Technology Consortium.

MMX is a trademark of Intel Corporation.

Windows is a registered trademark of Microsoft Corporation.

Other product names used in this publication are for identification purposes only and may be trademarks of their respective companies.

Contents

Revision History	11
1 Overview	1
1.1 QuantiSpeed™ Architecture Summary	2
2 Interface Signals	5
2.1 Overview	5
2.2 Signaling Technology	5
2.3 Push-Pull (PP) Drivers	6
2.4 AMD Athlon™ System Bus Signals	6
3 Logic Symbol Diagram	7
4 Power Management	9
4.1 Power Management States	9
Working State	10
Halt State	10
Stop Grant States	10
Probe State	12
4.2 Connect and Disconnect Protocol	12
Connect Protocol	12
Connect State Diagram	16
4.3 Clock Control	18
5 CPUID Support	19
6 Advanced 266 Front-Side Bus AMD Athlon™ XP Processor Model 8 Specifications	21
6.1 Part-Specific Electrical and Thermal Specifications for Advanced 266 FSB AMD Athlon XP Processors Model 8	21
6.2 Advanced 266 FSB AMD Athlon XP Processor Model 8 SYSCLK and SYSCLK# AC Characteristics	24
6.3 Advanced 266 FSB AMD Athlon System Bus AC Characteristics	25
7 Advanced 333 Front-Side Bus AMD Athlon™ XP Processor Model 8 Specifications	27
7.1 Electrical and Thermal Specifications for the Advanced 333 FSB AMD Athlon XP Processor Model 8	27
7.2 Advanced 333 FSB AMD Athlon XP Processor Model 8 SYSCLK and SYSCLK# AC Characteristics	28
7.3 Advanced 333 FSB AMD Athlon System Bus AC Characteristics	29

8	Electrical Data	31
8.1	Conventions	31
8.2	Interface Signal Groupings	31
8.3	Voltage Identification (VID[4:0])	33
8.4	Frequency Identification (FID[3:0])	33
8.5	VCCA AC and DC Characteristics	33
8.6	Decoupling	34
8.7	V _{CC_CORE} Characteristics	34
8.8	Absolute Ratings	36
8.9	SYSCLK and SYSCLK# DC Characteristics	37
8.10	AMD Athlon System Bus DC Characteristics	38
8.11	General AC and DC Characteristics	39
8.12	Open-Drain Test Circuit	41
8.13	Thermal Diode Characteristics	42
	Thermal Diode Electrical Characteristics	42
	Thermal Protection Characterization	43
8.14	APIC Pins AC and DC Characteristics	44
9	Signal and Power-Up Requirements	45
9.1	Power-Up Requirements	45
	Signal Sequence and Timing Description	45
	Clock Multiplier Selection (FID[3:0])	48
9.2	Processor Warm Reset Requirements	48
	Northbridge Reset Pins	48
10	Mechanical Data	49
10.1	Die Loading	49
10.2	Part Number 27291 OPGA Package Dimensions for AMD Athlon XP Processors Model 8 with a CUID of 680	50
10.3	Part Number 27291 OPGA Package Dimensions for AMD Athlon XP Processors Model 8 with a CUID of 681	51
10.4	Part Number 27648 OPGA Package Dimensions for AMD Athlon XP Processors Model 8 with a CUID of 681	53
11	Pin Descriptions	55
11.1	Pin Diagram and Pin Name Abbreviations	55
11.2	Pin List	65
11.3	Detailed Pin Descriptions	74
	A20M# Pin	74
	AMD Pin	74
	AMD Athlon System Bus Pins	74
	Analog Pin	74
	APIC Pins, PICCLK, PICD[1:0]#	74
	CLKFWRST Pin	74

CLKIN, RSTCLK (SYSCLK) Pins	74
CONNECT Pin	75
COREFB and COREFB# Pins	75
CPU_PRESENCE# Pin	75
DBRDY and DBREQ# Pins	75
FERR Pin	75
FID[3:0] Pins	75
FSB_Sense[1:0] Pins	77
FLUSH# Pin	77
IGNNE# Pin	77
INIT# Pin	77
INTR Pin	77
JTAG Pins	77
K7CLKOUT and K7CLKOUT# Pins	78
Key Pins	78
NC Pins	78
NMI Pin	78
PGA Orientation Pins	78
PLL Bypass and Test Pins	78
PWROK Pin	78
SADDIN[1:0]# and SADDOUT[1:0]# Pins	79
Scan Pins	79
SMI# Pin	79
STPCLK# Pin	79
SYSCLK and SYSCLK#	79
THERMDA and THERMDC Pins	79
VCCA Pin	79
VID[4:0] Pins	79
VREFSYS Pin	80
ZN and ZP Pins	80
12 Ordering Information	81
Standard AMD Athlon XP Processor Model 8 Products	81
Appendix A Thermal Diode Calculations	83
Appendix A	83
Ideal Diode Equation	83
Temperature Offset Correction	84
Appendix B Conventions and Abbreviations	87
Signals and Bits	87
Data Terminology	88
Abbreviations and Acronyms	89
Related Publications	93



et4U.com

DataShee

DataSheet4U.com

List of Figures

Figure 1.	Typical AMD Athlon™ XP Processor Model 8 System Block Diagram	3
Figure 2.	Logic Symbol Diagram.	7
Figure 3.	AMD Athlon XP Processor Model 8 Power Management States	9
Figure 4.	AMD Athlon System Bus Disconnect Sequence in the Stop Grant State.	14
Figure 5.	Exiting the Stop Grant State and Bus Connect Sequence	15
Figure 6.	Northbridge Connect State Diagram	16
Figure 7.	Processor Connect State Diagram	17
Figure 8.	SYSClk Waveform	24
Figure 9.	SYSClk Waveform	28
Figure 10.	V _{CC_CORE} Voltage Waveform	35
Figure 11.	SYSClk and SYSClk# Differential Clock Signals	37
Figure 12.	General ATE Open-Drain Test Circuit.	41
Figure 13.	Signal Relationship Requirements During Power-Up Sequence	45
Figure 14.	AMD Athlon XP Processor Model 8 Part Number 27291 OPGA Package.	52
Figure 15.	AMD Athlon XP Processor Model 8 Part Number 27648 OPGA Package.	54
Figure 16.	AMD Athlon XP Processor Model 8 Pin Diagram —Topside View	56
Figure 17.	AMD Athlon XP Processor Model 8 Pin Diagram —Bottomside View	57
Figure 18.	OPN Example for the AMD Athlon XP Processor Model 8	81



et4U.com

DataShee

DataSheet4U.com

List of Tables

Table 1.	Electrical and Thermal Specifications for Processors with a CUID of 680.	22
Table 2.	Electrical and Thermal Specifications for Processors with a CUID of 681.	23
Table 3.	SYCLK and SYCLK# AC Characteristics	24
Table 4.	AMD Athlon™ System Bus AC Characteristics	25
Table 5.	Electrical and Thermal Specifications.	27
Table 6.	SYCLK and SYCLK# AC Characteristics	28
Table 7.	AMD Athlon System Bus AC Characteristics	29
Table 8.	Interface Signal Groupings	31
Table 9.	VID[4:0] DC Characteristics	33
Table 10.	FID[3:0] DC Characteristics	33
Table 11.	VCCA AC and DC Characteristics	33
Table 12.	V _{CC_CORE} AC and DC Characteristics	34
Table 13.	Absolute Ratings	36
Table 14.	SYCLK and SYCLK# DC Characteristics	37
Table 15.	AMD Athlon System Bus DC Characteristics	38
Table 16.	General AC and DC Characteristics.	39
Table 17.	Thermal Diode Electrical Characteristics.	42
Table 18.	Guidelines for Platform Thermal Protection of the Processor	44
Table 19.	APIC Pin AC and DC Characteristics.	44
Table 20.	Mechanical Loading.	49
Table 21.	Part Number 27291 OPGA Package Dimensions for AMD Athlon XP Processors Model 8 with a CUID of 680	50
Table 22.	Part Number 27291 OPGA Package Dimensions for AMD Athlon XP Processors Model 8 with a CUID of 681	51
Table 23.	Part Number 27648 OPGA Package Dimensions for AMD Athlon XP Processors Model 8 with a CUID of 681	53
Table 24.	Pin Name Abbreviations	58
Table 25.	Cross-Reference by Pin Location	66
Table 26.	FID[3:0] Clock Multiplier Encodings.	76
Table 27.	Front-Side Bus Sense Truth Table	77



Table 28.	VID[4:0] Code to Voltage Definition	80
Table 29.	Constants and Variables for the Ideal Diode Equation	83
Table 30.	Constants and Variables Used in Temperature Offset Equations	84
Table 31.	Abbreviations	89
Table 32.	Acronyms	90

et4U.com

DataShee

DataSheet4U.com

Revision History

Date	Rev	Description
March 2003	H	<p>Public revision H of the <i>AMD Athlon™ XP Processor Model 8 Data Sheet</i> includes the following changes:</p> <ul style="list-style-type: none"> ■ In Chapter 6, revised Table 2, “Electrical and Thermal Specifications for Processors with a CUID of 681,” on page 23. ■ In Chapter 12, revised Figure 18, “OPN Example for the AMD Athlon™ XP Processor Model 8,” on page 81.
March 2003	G	<p>Public revision G of the <i>AMD Athlon™ XP Processor Model 8 Data Sheet</i> includes the following changes:</p> <ul style="list-style-type: none"> ■ In Chapter 6, revised Table 2, “Electrical and Thermal Specifications for Processors with a CUID of 681,” on page 23. ■ In Chapter 7, revised Table 6, “SYSCLK and SYSCLK# AC Characteristics,” on page 28. ■ In Chapter 10, renamed Table 21, “Part Number 27291 OPGA Package Dimensions for AMD Athlon™ XP Processors Model 8 with a CUID of 680,” on page 50, renamed Table 22, “Part Number 27291 OPGA Package Dimensions for AMD Athlon™ XP Processors Model 8 with a CUID of 681,” on page 51, added Table 23, “Part Number 27648 OPGA Package Dimensions for AMD Athlon™ XP Processors Model 8 with a CUID of 681,” on page 53, renamed Figure 14, “AMD Athlon™ XP Processor Model 8 Part Number 27291 OPGA Package,” on page 52, and added Figure 15, “AMD Athlon™ XP Processor Model 8 Part Number 27648 OPGA Package,” on page 54. ■ In Chapter 12, revised Figure 18, “OPN Example for the AMD Athlon™ XP Processor Model 8,” on page 81.
December 2002	F	<p>Public revision F of the <i>AMD Athlon™ XP Processor Model 8 Data Sheet</i> includes the following changes:</p> <ul style="list-style-type: none"> ■ In Chapter 6, revised Table 2, “Electrical and Thermal Specifications for Processors with a CUID of 681,” on page 23. ■ In Chapter 8, revised Table 16, “General AC and DC Characteristics,” on page 39 and Figure 12, “General ATE Open-Drain Test Circuit,” on page 41.
November 2002	E	<p>Public revision E of the <i>AMD Athlon™ XP Processor Model 8 Data Sheet</i> includes the following changes:</p> <ul style="list-style-type: none"> ■ In Chapter 6, revised Table 2, “Electrical and Thermal Specifications for Processors with a CUID of 681,” on page 23. ■ In Chapter 3, revised Figure 2, “Logic Symbol Diagram,” on page 7. ■ In Chapter 7, revised Table 5, “Electrical and Thermal Specifications,” on page 27. ■ In Chapter 8, revised Table 9, “VID[4:0] DC Characteristics,” on page 33. ■ In Chapter 12, revised Figure 18, “OPN Example for the AMD Athlon™ XP Processor Model 8,” on page 81.

Date	Rev	Description
October 2002	D	<p>Public revision D of the <i>AMD Athlon™ XP Processor Model 8 Data Sheet</i> includes the following changes:</p> <ul style="list-style-type: none"> ■ In Chapter 1, revised wording in Overview. ■ In Chapter 6, revised Table 2, “Electrical and Thermal Specifications for Processors with a CPUID of 681,” on page 23, added Table 3, “SYSCLK and SYSCLK# AC Characteristics,” on page 24, Figure 8, “SYSCLK Waveform,” on page 24, and Table 4, “AMD Athlon™ System Bus AC Characteristics,” on page 25. ■ Added Chapter 7, “Advanced 333 Front-Side Bus AMD Athlon™ XP Processor Model 8 Specifications” on page 27, Table 5, “Electrical and Thermal Specifications,” on page 27, Table 6, “SYSCLK and SYSCLK# AC Characteristics,” on page 28, Figure 9, “SYSCLK Waveform,” on page 28, and Table 7, “AMD Athlon™ System Bus AC Characteristics,” on page 29. ■ In Chapter 8, revised Table 8, “Interface Signal Groupings,” on page 31, Table 9, “VID[4:0] DC Characteristics,” on page 33, Table 10, “FID[3:0] DC Characteristics,” on page 33, and Table 19, “APIC Pin AC and DC Characteristics,” on page 44. ■ In Chapter 10, revised Table 21, “Part Number 27291 OPGA Package Dimensions for AMD Athlon™ XP Processors Model 8 with a CPUID of 680,” on page 50 and Table 22, “Part Number 27291 OPGA Package Dimensions for AMD Athlon™ XP Processors Model 8 with a CPUID of 681,” on page 51. ■ In Chapter 12, revised Figure 18, “OPN Example for the AMD Athlon™ XP Processor Model 8,” on page 81.
August 2002	C	<p>Public revision C of the <i>AMD Athlon™ XP Processor Model 8 Data Sheet</i> includes the following changes:</p> <ul style="list-style-type: none"> ■ In Chapter 3, revised Figure 2, “Logic Symbol Diagram,” on page 7. ■ In Chapter 6, added Table 1, “Electrical and Thermal Specifications for Processors with a CPUID of 680,” on page 22 and Table 2, “Electrical and Thermal Specifications for Processors with a CPUID of 681,” on page 23. ■ In Chapter 8, revised Table 8, “Interface Signal Groupings,” on page 31. ■ In Chapter 10, added Table 21, “Part Number 27291 OPGA Package Dimensions for AMD Athlon™ XP Processors Model 8 with a CPUID of 680,” on page 50 and Table 22, “Part Number 27291 OPGA Package Dimensions for AMD Athlon™ XP Processors Model 8 with a CPUID of 681,” on page 51. ■ In Chapter 11, revised Figure 16, “AMD Athlon™ XP Processor Model 8 Pin Diagram—Topside View,” on page 56, Figure 17, “AMD Athlon™ XP Processor Model 8 Pin Diagram—Bottomside View,” on page 57, Table 24, “Pin Name Abbreviations,” on page 58, Table 25, “Cross-Reference by Pin Location,” on page 66, and added “FSB_Sense[1:0] Pins” on page 77, and Table 27, “Front-Side Bus Sense Truth Table,” on page 77. ■ In Chapter 12, revised Figure 18, “OPN Example for the AMD Athlon™ XP Processor Model 8,” on page 81.
June 2002	B	First public release of the <i>AMD Athlon™ XP Processor Model 8 Data Sheet</i>

1 Overview

The AMD Athlon™ XP processor model 8 with QuantiSpeed™ architecture powers the next generation in computing platforms, delivering extreme performance for Windows® XP.

The AMD Athlon™ XP processor model 8, based on leading-edge 0.13 micron technology, integrates the innovative design and manufacturing expertise of AMD to deliver improved performance, lower power, and smaller die size while maintaining the stable and compatible Socket A infrastructure of the AMD Athlon processor.

Delivered in an OPGA package, the AMD Athlon XP processor model 8 delivers the integer, floating-point, and 3D multimedia performance for highly demanding applications running on x86 system platforms. The AMD Athlon XP processor model 8 delivers compelling performance for cutting-edge software applications that include high-speed Internet capability, digital content creation, digital photo editing, digital video, image compression, video encoding for streaming over the Internet, soft DVD, commercial 3D modeling, workstation-class computer-aided design (CAD), commercial desktop publishing, and speech recognition. The AMD Athlon XP processor model 8 also offers the scalability and reliability that IT managers and business users require for enterprise computing.

The AMD Athlon XP processor model 8 features a seventh-generation microarchitecture with an integrated, exclusive L2 cache, which supports the growing processor and system bandwidth requirements of emerging software, graphics, I/O, and memory technologies. The high-speed execution core of the AMD Athlon XP processor model 8 includes multiple x86 instruction decoders, a dual-ported 128-Kbyte split level-one (L1) cache, an exclusive 256-Kbyte L2 cache, three independent integer pipelines, three address calculation pipelines, and a superscalar, fully pipelined, out-of-order, three-way floating-point engine. The floating-point engine is capable of delivering outstanding performance on numerically complex applications.

The features of the AMD Athlon XP processor model 8 are QuantiSpeed™ architecture, a high-performance full-speed cache, an advanced 333 front-side Bus (FSB) with a 2.7-Gigabyte per second system bus, or an advanced 266 FSB with a 2.1-Gigabyte per second system bus, and 3DNow!™ Professional technology. The AMD Athlon system bus combines the latest technological advances, such as point-to-point topology, source-synchronous packet-based transfers, and low-voltage signaling to provide an extremely powerful, scalable bus for an x86 processor.

The AMD Athlon XP processor model 8 is binary-compatible with existing x86 software and backwards compatible with applications optimized for MMX™, SSE, and 3DNow! technology. Using a data format and single-instruction multiple-data (SIMD) operations based on the MMX instruction model, the AMD Athlon XP processor model 8 can produce as many as four, 32-bit, single-precision floating-point results per clock cycle. The 3DNow! Professional technology implemented in the AMD Athlon XP processor model 8 includes new integer multimedia instructions and software-directed data movement instructions for optimizing such applications as digital content creation and streaming video for the internet, as well as new instructions for digital signal processing (DSP) and communications applications.

1.1 QuantiSpeed™ Architecture Summary

The following features summarize the AMD Athlon XP processor model 8 QuantiSpeed architecture:

- Advanced 333 FSB technology available
- An advanced nine-issue, superpipelined, superscalar x86 processor microarchitecture designed for increased instructions per cycle (IPC) and high clock frequencies
- Fully pipelined floating-point unit that executes all x87 (floating-point), MMX, SSE and 3DNow! instructions
- Hardware data pre-fetch that increases and optimizes performance on high-end software applications utilizing high-bandwidth system capabilities
- Advanced two-level translation look-aside buffer (TLB) structures for both enhanced data and instruction address translation. The AMD Athlon XP processor model 8 with QuantiSpeed architecture incorporates three TLB optimizations: the L1 DTLB increases from 32 to 40 entries, the L2 ITLB and L2 DTLB both use exclusive architecture, and the TLB entries can be speculatively loaded.

The AMD Athlon XP processor model 8 delivers excellent system performance in a cost-effective, industry-standard form factor. The AMD Athlon XP processor model 8 is compatible with motherboards based on Socket A.

Figure 1 shows a typical AMD Athlon XP processor model 8 system block diagram.

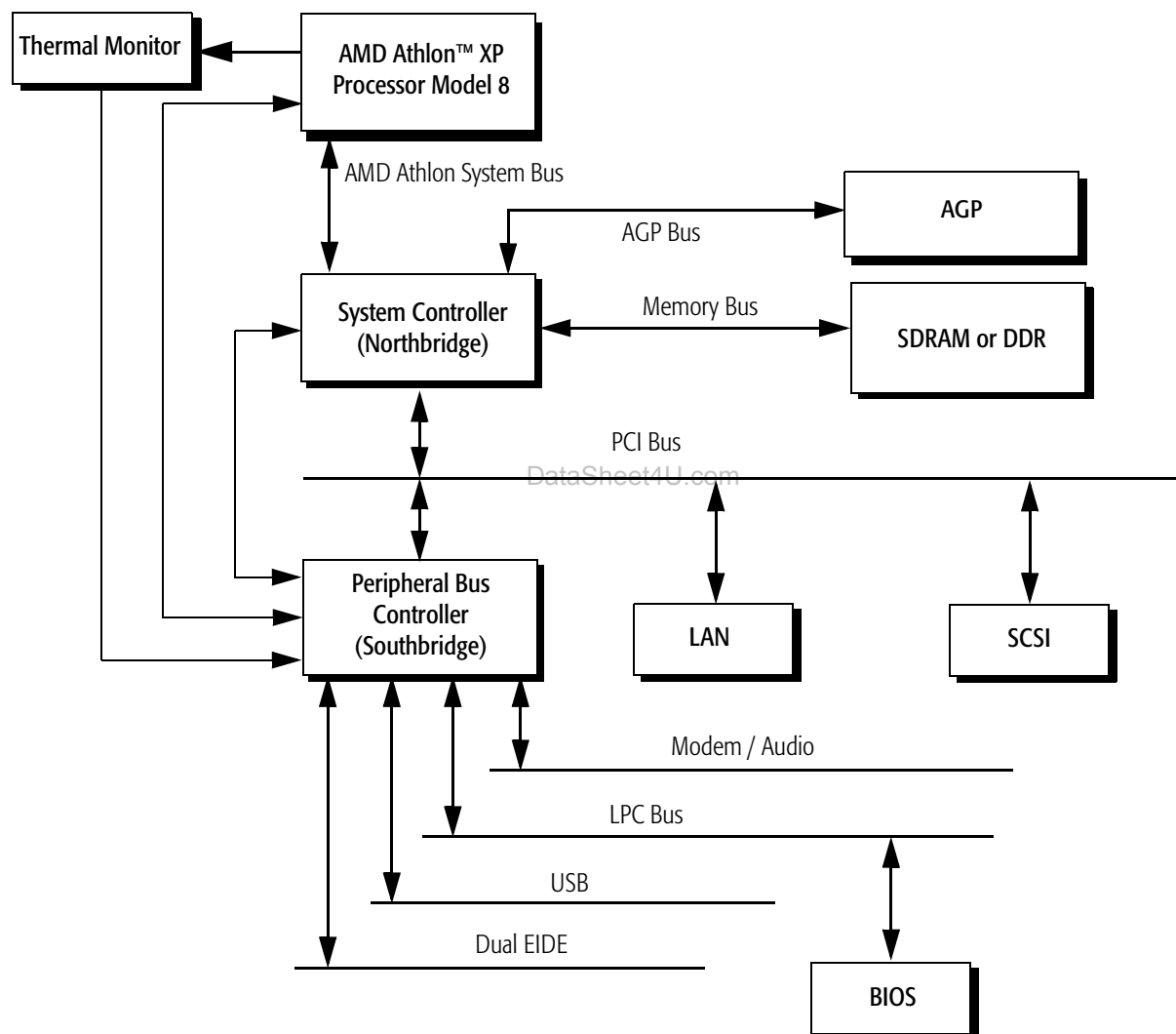

Figure 1. Typical AMD Athlon™ XP Processor Model 8 System Block Diagram



et4U.com

DataShee

DataSheet4U.com

2 Interface Signals

This section describes the interface signals utilized by the AMD Athlon™ XP processor model 8.

2.1 Overview

The AMD Athlon™ system bus architecture is designed to deliver excellent data movement bandwidth for next-generation x86 platforms as well as the high-performance required by enterprise-class application software. The system bus architecture consists of three high-speed channels (a unidirectional processor request channel, a unidirectional probe channel, and a 64-bit bidirectional data channel), source-synchronous clocking, and a packet-based protocol. In addition, the system bus supports several control, clock, and legacy signals. The interface signals use an impedance controlled push-pull, low-voltage, swing-signaling technology contained within the Socket A socket.

DataSheet4U.com

For more information, see “AMD Athlon™ System Bus Signals” on page 6, Chapter 11, “Pin Descriptions” on page 55, and the *AMD Athlon™ System Bus Specification*, order# 21902.

2.2 Signaling Technology

The AMD Athlon system bus uses a low-voltage, swing-signaling technology, that has been enhanced to provide larger noise margins, reduced ringing, and variable voltage levels. The signals are push-pull and impedance compensated. The signal inputs use differential receivers that require a reference voltage (V_{REF}). The reference signal is used by the receivers to determine if a signal is asserted or deasserted by the source. Termination resistors are not needed because the driver is impedance-matched to the motherboard and a high impedance reflection is used at the receiver to bring the signal past the input threshold.

For more information about pins and signals, see Chapter 11, “Pin Descriptions” on page 55.

2.3 Push-Pull (PP) Drivers

The AMD Athlon XP processor model 8 supports push-pull (PP) drivers. The system logic configures the processor with the configuration parameter called SysPushPull (1=PP). The impedance of the PP drivers is set to match the impedance of the motherboard by two external resistors connected to the ZN and ZP pins.

See “ZN and ZP Pins” on page 80 for more information.

2.4 AMD Athlon™ System Bus Signals

The AMD Athlon system bus is a clock-forwarded, point-to-point interface with the following three point-to-point channels:

- A 13-bit unidirectional output address/command channel
- A 13-bit unidirectional input address/command channel
- A 72-bit bidirectional data channel

For more information, see Chapter 8, “Electrical Data” on page 31 and the *AMD Athlon™ System Bus Specification*, order# 21902.

3 Logic Symbol Diagram

Figure 2 is the logic symbol diagram of the processor. This diagram shows the logical grouping of the input and output signals.

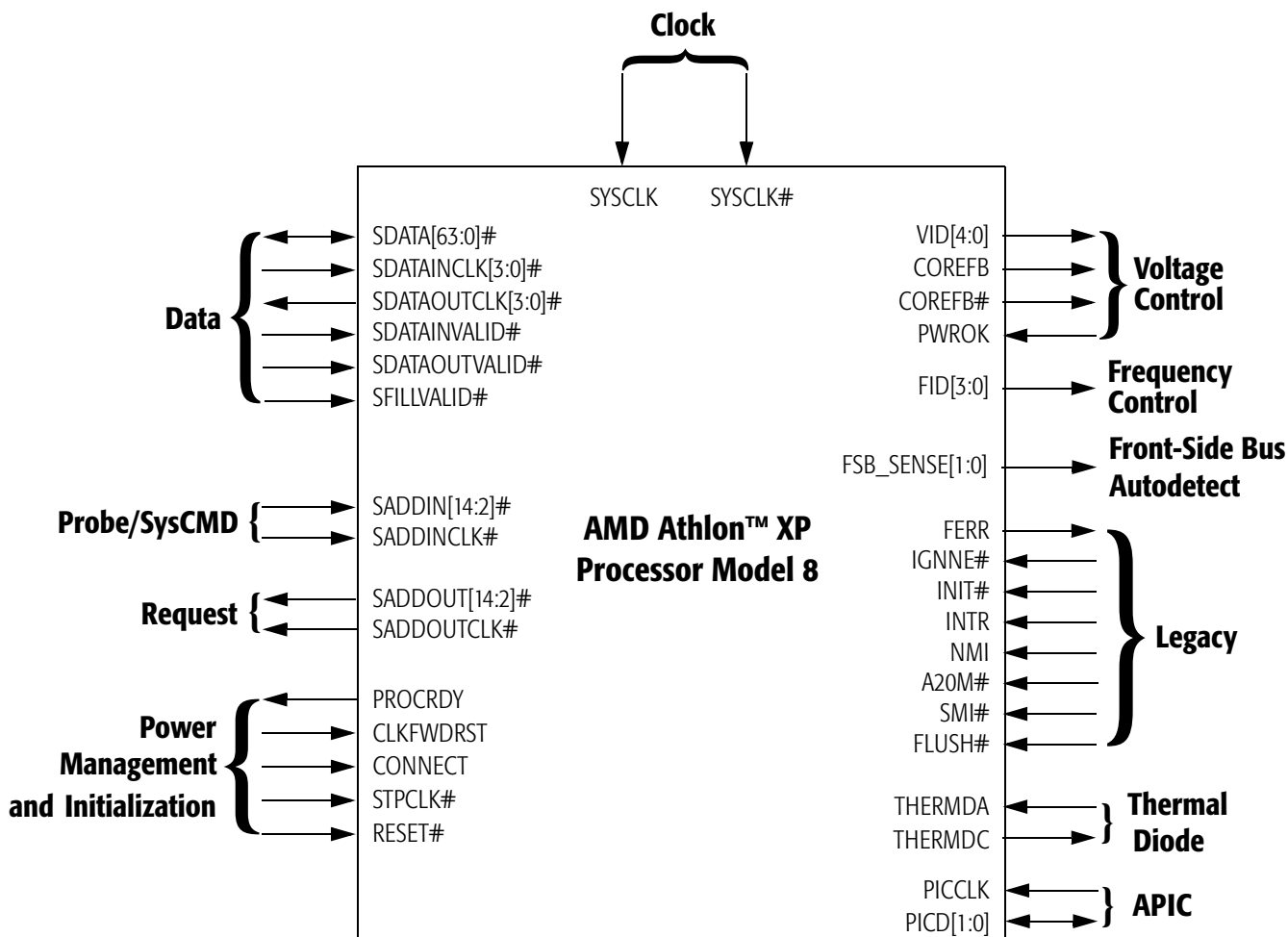

Figure 2. Logic Symbol Diagram



et4U.com

DataShee

DataSheet4U.com

4 Power Management

This chapter describes the power management control system of the AMD Athlon™ XP processor model 8. The power management features of the processor are compliant with the ACPI 1.0b and ACPI 2.0 specifications.

4.1 Power Management States

The AMD Athlon XP processor model 8 supports low-power Halt and Stop Grant states. These states are used by advanced configuration and power interface (ACPI) enabled operating systems for processor power management.

Figure 3 shows the power management states of the processor. The figure includes the ACPI “Cx” naming convention for these states.

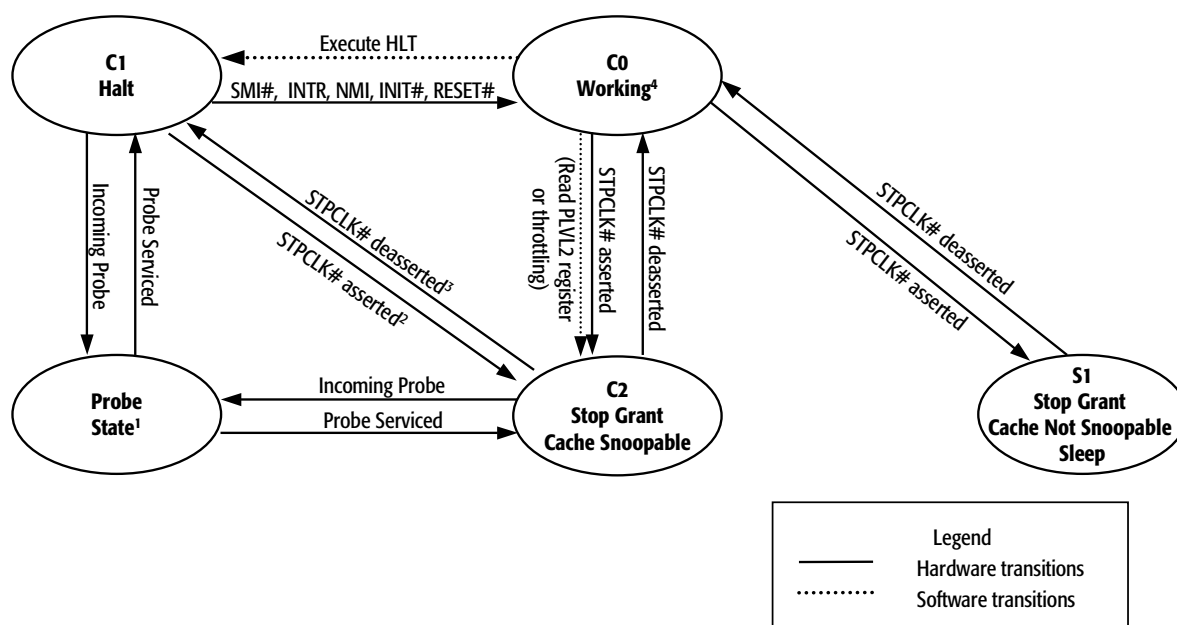

Note: The AMD Athlon™ System Bus is connected during the following states:

- 1) The Probe state
- 2) During transitions between the Halt state and the C2 Stop Grant state
- 3) During transitions between the C2 Stop Grant state and the Halt state
- 4) C0 Working state

Figure 3. AMD Athlon™ XP Processor Model 8 Power Management States

The following sections provide an overview of the power management states. For more details, refer to the *AMD Athlon™ System Bus Specification*, order# 21902.

Note: *In all power management states that the processor is powered, the system must not stop the system clock (SYSCLK/SYSCLK#) to the processor.*

Working State

The Working state is the state in which the processor is executing instructions.

Halt State

When the processor executes the HLT instruction, the processor enters the Halt state and issues a Halt special cycle to the AMD Athlon system bus. The processor only enters the low power state dictated by the CLK_Ctl MSR if the system controller (Northbridge) disconnects the AMD Athlon system bus in response to the Halt special cycle.

If STPCLK# is asserted, the processor will exit the Halt state and enter the Stop Grant state. The processor will initiate a system bus connect, if it is disconnected, then issue a Stop Grant special cycle. When STPCLK# is deasserted, the processor will exit the Stop Grant state and re-enter the Halt state. The processor will issue a Halt special cycle when re-entering the Halt state.

The Halt state is exited when the processor detects the assertion of INIT#, RESET#, SMI#, or an interrupt via the INTR or NMI pins, or via a local APIC interrupt message. When the Halt state is exited, the processor will initiate an AMD Athlon system bus connect if it is disconnected.

Stop Grant States

The processor enters the Stop Grant state upon recognition of assertion of STPCLK# input. After entering the Stop Grant state, the processor issues a Stop Grant special bus cycle on the AMD Athlon system bus. The processor is not in a low-power state at this time, because the AMD Athlon system bus is still connected. After the Northbridge disconnects the AMD Athlon system bus in response to the Stop Grant special bus cycle, the processor enters a low-power state dictated by the CLK_Ctl MSR. If the Northbridge needs to probe the processor during the Stop Grant state while the system bus is disconnected, it must first connect the system bus. Connecting the system bus

places the processor into the higher power probe state. After the Northbridge has completed all probes of the processor, the Northbridge must disconnect the AMD Athlon system bus again so that the processor can return to the low-power state. During the Stop Grant states, the processor latches INIT#, INTR, NMI, SMI#, or a local APIC interrupt message, if they are asserted.

The Stop Grant state is exited upon the deassertion of STPCLK# or the assertion of RESET#. When STPCLK# is deasserted, the processor initiates a connect of the AMD Athlon system bus if it is disconnected. After the processor enters the Working state, any pending interrupts are recognized and serviced and the processor resumes execution at the instruction boundary where STPCLK# was initially recognized. If RESET# is sampled asserted during the Stop Grant state, the processor exits the Stop Grant state and the reset process begins.

There are two mechanisms for asserting STPCLK#—hardware and software.

The Southbridge can force STPCLK# assertion for throttling to protect the processor from exceeding its maximum case temperature. This is accomplished by asserting the THERM# input to the Southbridge. Throttling asserts STPCLK# for a percentage of a predefined throttling period: STPCLK# is repetitively asserted and deasserted until THERM# is deasserted.

Software can force the processor into the Stop Grant state by accessing ACPI-defined registers typically located in the Southbridge.

The operating system places the processor into the C2 Stop Grant state by reading the P_LVL2 register in the Southbridge.

If an ACPI Thermal Zone is defined for the processor, the operating system can initiate throttling with STPCLK# using the ACPI defined P_CNT register in the Southbridge. The Northbridge connects the AMD Athlon system bus, and the processor enters the Probe state to service cache snoops during Stop Grant for C2 or throttling.

In C2, probes are allowed, as shown in Figure 3 on page 9

The Stop Grant state is also entered for the S1, Powered On Suspend, system sleep state based on a write to the SLP_TYP and SLP_EN fields in the ACPI-defined Power Management 1 control register in the Southbridge. During the S1 Sleep state, system software ensures no bus master or probe activity occurs. The Southbridge deasserts STPCLK# and brings the processor out of the S1 Stop Grant state when any enabled resume event occurs.

Probe State

The Probe state is entered when the Northbridge connects the AMD Athlon system bus to probe the processor (for example, to snoop the processor caches) when the processor is in the Halt or Stop Grant state. When in the Probe state, the processor responds to a probe cycle in the same manner as when it is in the Working state. When the probe has been serviced, the processor returns to the same state as when it entered the Probe state (Halt or Stop Grant state). When probe activity is completed the processor only returns to a low-power state after the Northbridge disconnects the AMD Athlon system bus again.

4.2 Connect and Disconnect Protocol

Significant power savings of the processor only occur if the processor is disconnected from the system bus by the Northbridge while in the Halt or Stop Grant state. The Northbridge can optionally initiate a bus disconnect upon the receipt of a Halt or Stop Grant special cycle. The option of disconnecting is controlled by an enable bit in the Northbridge. If the Northbridge requires the processor to service a probe after the system bus has been disconnected, it must first initiate a system bus connect.

Connect Protocol

In addition to the legacy STPCLK# signal and the Halt and Stop Grant special cycles, the AMD Athlon system bus connect protocol includes the CONNECT, PROCRDY, and CLKFWDRST signals and a Connect special cycle.

AMD Athlon system bus disconnects are initiated by the Northbridge in response to the receipt of a Halt or Stop Grant. Reconnect is initiated by the processor in response to an interrupt for Halt or STPCLK# deassertion. Reconnect is initiated by the Northbridge to probe the processor.

The Northbridge contains BIOS programmable registers to enable the system bus disconnect in response to Halt and Stop Grant special cycles. When the Northbridge receives the Halt or Stop Grant special cycle from the processor and, if there are no outstanding probes or data movements, the Northbridge deasserts CONNECT a minimum of eight SYSCLK periods after the last command sent to the processor. The processor detects the deassertion of CONNECT on a rising edge of SYSCLK and deasserts PROCRDY to the Northbridge. In return, the Northbridge asserts CLKFWRST in anticipation of reestablishing a connection at some later point.

Note: *The Northbridge must disconnect the processor from the AMD Athlon system bus before issuing the Stop Grant special cycle to the PCI bus or passing the Stop Grant special cycle to the Southbridge for systems that connect to the Southbridge with HyperTransport™ technology.*

This note applies to current chipset implementation—alternate chipset implementations that do not require this are possible.

Note: *In response to Halt special cycles, the Northbridge passes the Halt special cycle to the PCI bus or Southbridge immediately.*

The processor can receive an interrupt after it sends a Halt special cycle, or STPCLK# deassertion after it sends a Stop Grant special cycle to the Northbridge but before the disconnect actually occurs. In this case, the processor sends the Connect special cycle to the Northbridge, rather than continuing with the disconnect sequence. In response to the Connect special cycle, the Northbridge cancels the disconnect request.

The system is required to assert the CONNECT signal before returning the C-bit for the connect special cycle (assuming CONNECT has been deasserted).

For more information, see the *AMD Athlon™ System Bus Specification*, order# 21902 for the definition of the C-bit and the Connect special cycle.

Figure 4 shows STPCLK# assertion resulting in the processor in the Stop Grant state and the AMD Athlon system bus disconnected.

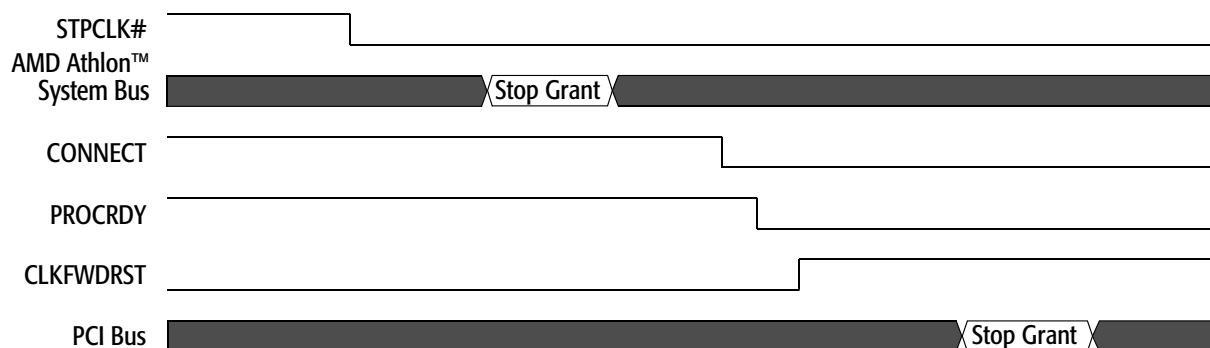

Figure 4. AMD Athlon™ System Bus Disconnect Sequence in the Stop Grant State

An example of the AMD Athlon system bus disconnect sequence is as follows:

1. The peripheral controller (Southbridge) asserts STPCLK# to place the processor in the Stop Grant state.
2. When the processor recognizes STPCLK# asserted, it enters the Stop Grant state and then issues a Stop Grant special cycle.
3. When the special cycle is received by the Northbridge, it deasserts CONNECT, assuming no probes are pending, initiating a bus disconnect to the processor.
4. The processor responds to the Northbridge by deasserting PROCRDY.
5. The Northbridge asserts CLKFWRST to complete the bus disconnect sequence.
6. After the processor is disconnected from the bus, the processor enters a low-power state. The Northbridge passes the Stop Grant special cycle along to the Southbridge.

Figure 5 shows the signal sequence of events that takes the processor out of the Stop Grant state, connects the processor to the AMD Athlon system bus, and puts the processor into the Working state.

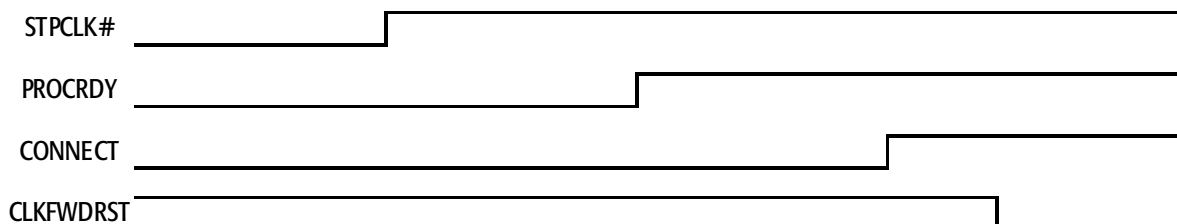

Figure 5. Exiting the Stop Grant State and Bus Connect Sequence

The following sequence of events removes the processor from the Stop Grant state and connects it to the system bus:

1. The Southbridge deasserts STPCLK#, informing the processor of a wake event.
2. When the processor recognizes STPCLK# deassertion, it exits the low-power state and asserts PROCRDY, notifying the Northbridge to connect to the bus.
3. The Northbridge asserts CONNECT.
4. The Northbridge deasserts CLKFWRST, synchronizing the forwarded clocks between the processor and the Northbridge.
5. The processor issues a Connect special cycle on the system bus and resumes operating system and application code execution.

Connect State Diagram

Figure 6 below and Figure 7 on page 17 show the Northbridge and processor connect state diagrams, respectively.

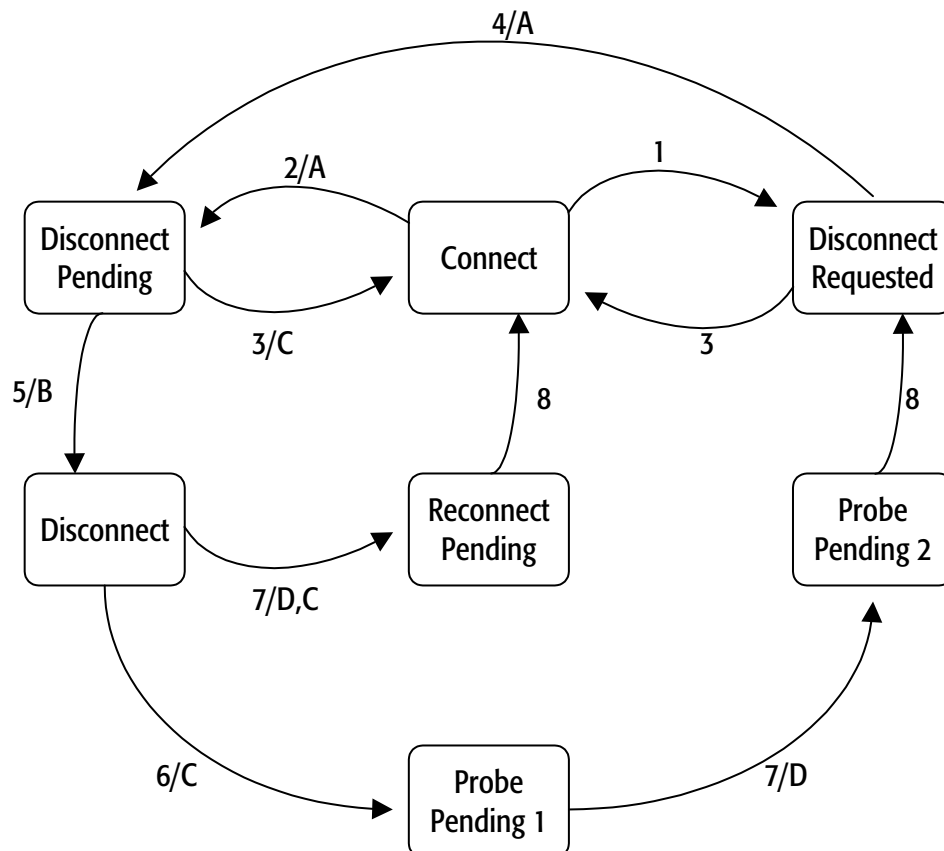

	Condition
1	A disconnect is requested and probes are still pending.
2	A disconnect is requested and no probes are pending.
3	A Connect special cycle from the processor.
4	No probes are pending.
5	PROCRDY is deasserted.
6	A probe needs service.
7	PROCRDY is asserted.
8	Three SYSCLK periods after CLKFWRST is deasserted. <i>Although reconnected to the system interface, the Northbridge must not issue any non-NOP SysDC commands for a minimum of four SYSCLK periods after deasserting CLKFWRST.</i>

	Action
A	Deassert CONNECT eight SYSCLK periods after last SysDC sent.
B	Assert CLKFWRST.
C	Assert CONNECT.
D	Deassert CLKFWRST.

Figure 6. Northbridge Connect State Diagram

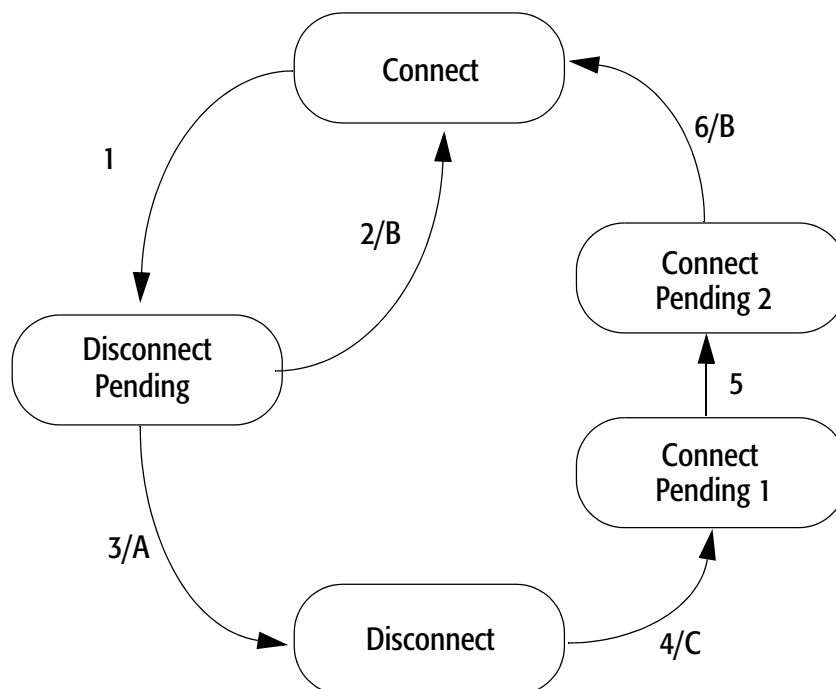

Condition		Action	
1	CONNECT is deasserted by the Northbridge (for a previously sent Halt or Stop Grant special cycle).	A	CLKFWRST is asserted by the Northbridge.
2	Processor receives a wake-up event and must cancel the disconnect request.	B	Issue a Connect special cycle.*
3	Deassert PROCRDY and slow down internal clocks.	C	Return internal clocks to full speed and assert PROCRDY.
4	Processor wake-up event or CONNECT asserted by Northbridge.	Note: * The Connect special cycle is only issued after a processor wake-up event (interrupt or STPCLK# deassertion) occurs. If the AMD Athlon™ system bus is connected so the Northbridge can probe the processor, a Connect special cycle is not issued at that time (it is only issued after a subsequent processor wake-up event).	
5	CLKFWRST is deasserted by the Northbridge.		
6	Forward clocks start three SYSClk periods after CLKFWRST is deasserted.		

Figure 7. Processor Connect State Diagram

4.3 Clock Control

The processor implements a Clock Control (CLK_Ctl) MSR (address C001_001Bh) that determines the internal clock divisor when the AMD Athlon system bus is disconnected.

Refer to the *AMD Athlon™ and AMD Duron™ Processors BIOS, Software, and Debug Developers Guide*, order# 21656, for more details on the CLK_Ctl register.

5 CPUID Support

AMD Athlon™ XP processor model 8 version and feature set recognition can be performed through the use of the CPUID instruction, that provides complete information about the processor—vendor, type, name, etc., and its capabilities. Software can make use of this information to accurately tune the system for maximum performance and benefit to users.

For information on the use of the CPUID instruction see the following documents:

- *AMD Processor Recognition Application Note*, order# 20734
- *AMD Athlon™ Processor Recognition Application Note Addendum*, order# 21922
- *AMD Athlon™ and AMD Duron™ Processors BIOS, Software, and Debug Developers Guide*, order# 21656



et4U.com

DataShee

DataSheet4U.com

6 Advanced 266 Front-Side Bus AMD Athlon™ XP Processor Model 8 Specifications

This chapter describes the electrical specifications that are unique to the advanced 266 front-side bus (FSB) AMD Athlon™ XP processor model 8.

6.1 Part-Specific Electrical and Thermal Specifications for Advanced 266 FSB AMD Athlon™ XP Processors Model 8

This section provides part-specific electrical and thermal information for each type of the Advanced 266 FSB AMD Athlon XP processors model 8 in Table 1 on page 22 and Table 2 on page 23.

Table 1 shows the part-specific electrical and thermal specifications in the C0 working state and the S1 Stop Grant state for processors with a CPUID = 680.

Table 1. Electrical and Thermal Specifications for Processors with a CPUID of 680

Frequency in MHz (Model Number)	V _{CC_CORE} (Core Voltage)	I _{CC} (Processor Current)				Thermal Power ⁵		Maximum Die Temperature
		Working State C0		Stop Grant S1 ^{1, 2, 3, 4}		Maximum	Typical	
		Maximum	Typical	Maximum	Typical			
1467 (1700+)	1.50 V	32.9 A	29.9 A	5.87 A	3.7 A	49.4 W	44.9 W	90°C
1533 (1800+)		34.0 A	30.9 A			51.0 W	46.3 W	
1600 (1900+)		35.0 A	31.8 A			52.5 W	47.7 W	
1667 (2000+)	1.60 V	37.7 A	34.2 A	7.68 A	4.7 A	60.3 W	54.7 W	
	1.65 V	36.5 A	33.2 A	8.85 A	5.4 A			
1733 (2100+)	1.60 V	38.8 A	35.2 A	7.68 A	4.7 A	62.1 W	56.4 W	
1800 (2200+)	1.65 V	41.2 A	37.4 A	8.85 A	5.4 A	67.9 W	61.7 W	85°C

Notes:

1. See Figure 3, "AMD Athlon™ XP Processor Model 8 Power Management States" on page 9.
2. The maximum Stop Grant currents are absolute worst case currents for parts that may yield from the worst case corner of the process and are not representative of the typical Stop Grant current that is currently about one-third of the maximum specified current.
3. These currents occur when the AMD Athlon™ system bus is disconnected and has a low power ratio of 1/8 for Stop Grant disconnect and a low power ratio of 1/8 Halt disconnect applied to the core clock grid of the processor as dictated by a value of 6003_1223h programmed into the Clock Control (CLK_Ctl) MSR. For more information, refer to the AMD Athlon™ and AMD Duron™ Processors BIOS, Software, and Debug Developers Guide, order# 21656.
4. The Stop Grant current consumption is characterized at 50°C and not tested.
5. Thermal design power represents the maximum sustained power dissipated while executing publicly-available software or instruction sequences under normal system operation at nominal V_{CC_CORE}. Thermal solutions must monitor the temperature of the processor to prevent the processor from exceeding its maximum die temperature.

Table 2 shows the part-specific electrical and thermal specifications in the C0 working state and the S1 Stop Grant state for processors with a CPUID = 681

Table 2. Electrical and Thermal Specifications for Processors with a CPUID of 681

Frequency in MHz (Model Number)	V _{CC_CORE} (Core Voltage)	I _{CC} (Processor Current)				Thermal Power ⁵		Maximum Die Temperature
		Working State C0		Stop Grant S1 ^{1, 2, 3, 4}		Maximum	Typical	
		Maximum	Typical	Maximum	Typical			
1400 (1600+)	1.60 V	30.3 A	27.5 A	8.1 A	4.9 A	48.5 W	44.0 W	90°C
1467 (1700+)	1.50 V	32.9 A	29.9 A	5.4 A	3.9 A	49.4 W	44.9 W	
	1.60 V	30.9 A	28.0 A	8.1 A	4.9 A	49.4 W	44.9 W	
1533 (1800+)	1.50 V	34.0 A	30.9 A	5.4 A	3.9 A	51.0 W	46.3 W	
	1.60 V	31.9 A	28.9 A	8.1 A	4.9 A	51.0 W	46.3 W	
1667 (2000+)	1.60 V	37.7 A	34.2 A	8.1 A	4.9 A	60.3 W	54.7 W	
1733 (2100+)	1.60 V	38.8 A	34.9 A	8.1 A	4.9 A	62.1 W	55.9 W	85°C
1800 (2200+)	1.60 V	39.3 A	35.6 A	8.1 A	4.9 A	62.8 W	57.0 W	
2000 (2400+)	1.65 V	41.4 A	37.6 A	8.9 A	5.4 A	68.3 W	62.0 W	
2133 (2600+)	1.65 V	41.4 A	37.6 A	8.9 A	5.4 A	68.3 W	62.0 W	

Notes:

1. See Figure 3, "AMD Athlon™ XP Processor Model 8 Power Management States" on page 9.
2. The maximum Stop Grant currents are absolute worst case currents for parts that may yield from the worst case corner of the process and are not representative of the typical Stop Grant current that is currently about one-third of the maximum specified current.
3. These currents occur when the AMD Athlon™ system bus is disconnected and has a low power ratio of 1/8 for Stop Grant disconnect and a low power ratio of 1/8 Halt disconnect applied to the core clock grid of the processor as dictated by a value of 2003_1223h programmed into the Clock Control (CLK_Ctl) MSR. For more information, refer to the AMD Athlon™ and AMD Duron™ Processors BIOS, Software, and Debug Developers Guide, order# 21656.
4. The Stop Grant current consumption is characterized at 50°C and not tested.
5. Thermal design power represents the maximum sustained power dissipated while executing publicly-available software or instruction sequences under normal system operation at nominal V_{CC_CORE}. Thermal solutions must monitor the temperature of the processor to prevent the processor from exceeding its maximum die temperature.

6.2 Advanced 266 FSB AMD Athlon™ XP Processor Model 8 SYSCLK and SYSCLK# AC Characteristics

Table 3 shows the SYSCLK/SYSCLK# differential clock AC characteristics of this processor.

Table 3. SYSCLK and SYSCLK# AC Characteristics

Symbol	Parameter Description	Minimum	Maximum	Units	Notes
	Clock Frequency	50	133	MHz	1
	Duty Cycle	30%	70%		
t_1	Period	7.5		ns	2, 3
t_2	High Time	1.05		ns	
t_3	Low Time	1.05		ns	
t_4	Fall Time		2	ns	
t_5	Rise Time		2	ns	
	Period Stability		± 300	ps	

Notes:

1. The AMD Athlon™ system bus operates at twice this clock frequency.
2. Circuitry driving the AMD Athlon system bus clock inputs must exhibit a suitably low closed-loop jitter bandwidth to allow the PLL to track the jitter. The -20dB attenuation point, as measured into a 20- or 30-pF load must be less than 500 kHz.
3. Circuitry driving the AMD Athlon system bus clock inputs may purposely alter the AMD Athlon system bus clock frequency (spread spectrum clock generators). In no cases can the AMD Athlon system bus period violate the minimum specification above. AMD Athlon system bus clock inputs can vary from 100% of the specified frequency to 99% of the specified frequency at a maximum rate of 100 kHz.

Figure 8 shows a sample waveform of the SYSCLK signal.

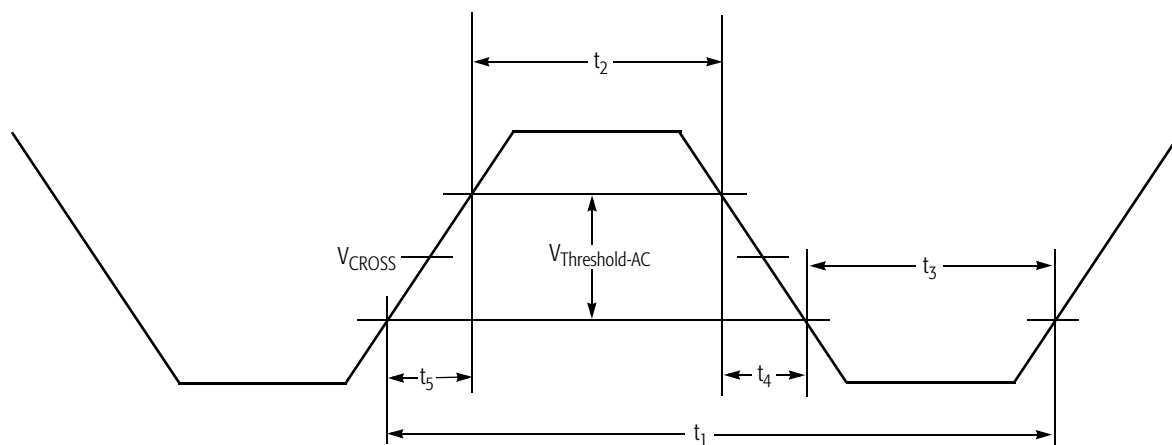

Figure 8. SYSCLK Waveform

6.3 Advanced 266 FSB AMD Athlon™ System Bus AC Characteristics

The AC characteristics for the AMD Athlon system bus of this processor are shown in Table 4. The parameters are grouped based on the source or destination of the signals involved.

Table 4. AMD Athlon™ System Bus AC Characteristics

Group	Symbol	Parameter	Min	Max	Units	Notes
All Signals	T_{RISE}	Output Rise Slew Rate	1	3	V/ns	1
	T_{FALL}	Output Fall Slew Rate	1	3	V/ns	1
Forward Clocks	$T_{SKEW-SAMEEDGE}$	Output skew with respect to the same clock edge	–	385	ps	2
	$T_{SKEW-DIFFEDGE}$	Output skew with respect to a different clock edge	–	770	ps	2
	T_{SU}	Input Data Setup Time	300		ps	3
	T_{HD}	Input Data Hold Time	300		ps	3
	C_{IN}	Capacitance on input Clocks	4	25	pF	
	C_{OUT}	Capacitance on output Clocks	4	12	pF	
Sync	T_{VAL}	RSTCLK to Output Valid	250	2000	ps	4, 5
	T_{SU}	Setup to RSTCLK	500		ps	4, 6
	T_{HD}	Hold from RSTCLK	1000		ps	4, 6

Notes:

- Rise and fall time ranges are guidelines over which the I/O has been characterized.
- $T_{SKEW-SAMEEDGE}$ is the maximum skew within a clock forwarded group between any two signals or between any signal and its forward clock, as measured at the package, with respect to the same clock edge.
 $T_{SKEW-DIFFEDGE}$ is the maximum skew within a clock forwarded group between any two signals or between any signal and its forward clock, as measured at the package, with respect to different clock edges.
- Input SU and HD times are with respect to the appropriate Clock Forward Group input clock.
- The synchronous signals include PROCRDY, CONNECT, and CLKFWRDST.
- T_{VAL} is RSTCLK rising edge to output valid for PROCRDY. Test Load is 25 pF.
- T_{SU} is setup of CONNECT/CLKFWRDST to rising edge of RSTCLK. T_{HD} is hold of CONNECT/CLKFWRDST from rising edge of RSTCLK.



et4U.com

DataShee

DataSheet4U.com

7 Advanced 333 Front-Side Bus AMD Athlon™ XP Processor Model 8 Specifications

This chapter describes the electrical specifications that are unique to the advanced 333 front-side bus (FSB) AMD Athlon™ XP processor model 8.

7.1 Electrical and Thermal Specifications for the Advanced 333 FSB AMD Athlon™ XP Processor Model 8

Table 5 shows the electrical and thermal specifications for this processor in the C0 working state and the S1 Stop Grant state.

Table 5. Electrical and Thermal Specifications

Frequency in MHz (Model Number)	V _{CC_CORE} (Core Voltage)	I _{CC} (Processor Current)				Thermal Power ⁵		Maximum Die Temperature
		Working State C0		Stop Grant S1 ^{1, 2, 3, 4}		Maximum	Typical	
		Maximum	Typical	Maximum	Typical			
2083 (2600+)	1.65 V	41.4 A	37.6 A	8.9 A	5.9 A	68.3 W	62.0 W	85°C
2167 (2700+)								

Notes:

1. See Figure 3, "AMD Athlon™ XP Processor Model 8 Power Management States" on page 9.
2. The maximum Stop Grant currents are absolute worst case currents for parts that may yield from the worst case corner of the process and are not representative of the typical Stop Grant current that is currently about one-third of the maximum specified current.
3. These currents occur when the AMD Athlon™ system bus is disconnected and has a low power ratio of 1/8 for Stop Grant disconnect and a low power ratio of 1/8 Halt disconnect applied to the core clock grid of the processor as dictated by a value of 2003_1223h programmed into the Clock Control (CLK_Ctl) MSR. For more information, refer to the AMD Athlon™ and AMD Duron™ Processors BIOS, Software, and Debug Developers Guide, order# 21656.
4. The Stop Grant current consumption is characterized at 50°C and not tested.
5. Thermal design power represents the maximum sustained power dissipated while executing publicly-available software or instruction sequences under normal system operation at nominal V_{CC_CORE}. Thermal solutions must monitor the temperature of the processor to prevent the processor from exceeding its maximum die temperature.

7.2 Advanced 333 FSB AMD Athlon™ XP Processor Model 8 SYSCLK and SYSCLK# AC Characteristics

Table 6 shows the SYSCLK/SYSCLK# differential clock AC characteristics of this processor.

Table 6. SYSCLK and SYSCLK# AC Characteristics

Symbol	Parameter Description	Minimum	Maximum	Units	Notes
	Clock Frequency	50	166	MHz	1
	Duty Cycle	30%	70%		
t_1	Period	6		ns	2, 3
t_2	High Time	1.0		ns	
t_3	Low Time	1.0		ns	
t_4	Fall Time		2	ns	
t_5	Rise Time		2	ns	
	Period Stability		± 300	ps	

Notes:

1. The AMD Athlon™ system bus operates at twice this clock frequency.
2. Circuitry driving the AMD Athlon system bus clock inputs must exhibit a suitably low closed-loop jitter bandwidth to allow the PLL to track the jitter. The -20dB attenuation point, as measured into a 20- or 30-pF load must be less than 500 kHz.
3. Circuitry driving the AMD Athlon system bus clock inputs may purposely alter the AMD Athlon system bus clock frequency (spread spectrum clock generators). In no cases can the AMD Athlon system bus period violate the minimum specification above. AMD Athlon system bus clock inputs can vary from 100% of the specified frequency to 99% of the specified frequency at a maximum rate of 100 kHz.

Figure 9 shows a sample waveform of the SYSCLK signal.

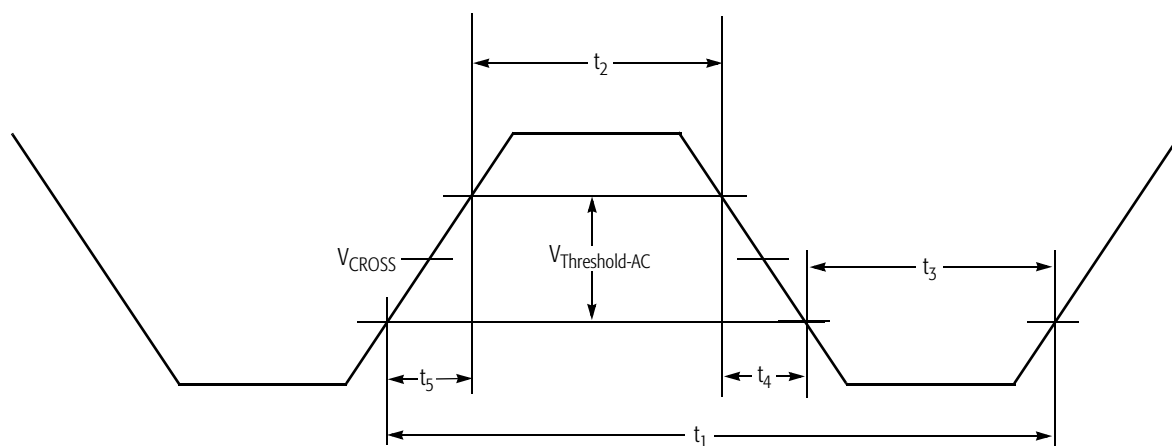

Figure 9. SYSCLK Waveform

7.3 Advanced 333 FSB AMD Athlon™ System Bus AC Characteristics

The AC characteristics of the AMD Athlon system bus of this processor are shown in Table 7. The parameters are grouped based on the source or destination of the signals involved.

Table 7. AMD Athlon™ System Bus AC Characteristics

Group	Symbol	Parameter	Min	Max	Units	Notes
All Signals	T_{RISE}	Output Rise Slew Rate	1	3	V/ns	1
	T_{FALL}	Output Fall Slew Rate	1	3	V/ns	1
Forward Clocks	$T_{SKEW-DIFFEDGE}$	Output skew with respect to a different clock edge	–	770	ps	2
	T_{SU}	Input Data Setup Time	300		ps	3
	T_{HD}	Input Data Hold Time	300		ps	3
	C_{IN}	Capacitance on input Clocks	4	25	pF	
	C_{OUT}	Capacitance on output Clocks	4	12	pF	
Sync	T_{VAL}	RSTCLK to Output Valid	800	2000	ps	4, 5
	T_{SU}	Setup to RSTCLK	500		ps	4, 6
	T_{HD}	Hold from RSTCLK	500		ps	4, 6

Notes:

1. Rise and fall time ranges are guidelines over which the I/O has been characterized.
2. $T_{SKEW-DIFFEDGE}$ is the maximum skew within a clock forwarded group between any two signals or between any signal and its forward clock, as measured at the package, with respect to different clock edges.
3. Input SU and HD times are with respect to the appropriate Clock Forward Group input clock.
4. The synchronous signals include PROC RDY, CONNECT, and CLK FWD RST.
5. T_{VAL} is RSTCLK rising edge to output valid for PROC RDY. Test Load is 25 pF.
6. T_{SU} is setup of CONNECT/CLK FWD RST to rising edge of RSTCLK. T_{HD} is hold of CONNECT/CLK FWD RST from rising edge of RSTCLK.



et4U.com

DataShee

DataSheet4U.com

8 Electrical Data

This chapter describes the electrical characteristics that apply to all desktop AMD Athlon™ XP processors model 8.

8.1 Conventions

The conventions used in this chapter are as follows:

- Current specified as being sourced by the processor is *negative*.
- Current specified as being sunk by the processor is *positive*.

8.2 Interface Signal Groupings

The electrical data in this chapter is presented separately for each signal group.

Table 8 defines each group and the signals contained in each group.

Table 8. Interface Signal Groupings

Signal Group	Signals	Notes
AMD Athlon™ System Bus	SADDIN[14:2]#, SADDOUT[14:2]#, SADDINCLK#, SADDOUTCLK#, SFILLVAL#, SDATAINVAL#, SDATAOUTVAL#, SDATA[63:0]#, SDATAINCLK[3:0]#, SDATAOUTCLK[3:0]#, CLKFWRST, PROCRDY, CONNECT	See “Advanced 266 FSB AMD Athlon™ System Bus AC Characteristics” on page 25, “Advanced 333 FSB AMD Athlon™ System Bus AC Characteristics” on page 29, “AMD Athlon™ System Bus DC Characteristics” on page 36, and “CLKFWRST Pin” on page 73.
APIC	PICD[1:0]#, PICCLK	See “APIC Pins AC and DC Characteristics” on page 44, and “APIC Pins, PICCLK, PICD[1:0]#” on page 73.
Frequency	FID[3:0], FSB_Sense[1:0]	See “Frequency Identification (FID[3:0])” on page 33, “FID[3:0] Pins” on page 75, and “FSB_Sense[1:0] Pins” on page 76.
JTAG	TMS, TCK, TRST#, TDI, TDO	See “General AC and DC Characteristics” on page 39.

Table 8. Interface Signal Groupings (continued)

Signal Group	Signals	Notes
Power	VID[4:0], VCCA, V _{CC_CORE} , COREFB, COREFB#	See "Voltage Identification (VID[4:0])" on page 33, "VID[4:0] Pins" on page 78, "VCCA AC and DC Characteristics" on page 33, "V _{CC_CORE} Characteristics" on page 34, "VCCA Pin" on page 78, and "COREFB and COREFB# Pins" on page 74.
Southbridge	RESET#, INTR, NMI, SMI#, INIT#, A20M#, FERR, IGNNE#, STPCLK#, FLUSH#	See "General AC and DC Characteristics" on page 39, "INTR Pin" on page 76, "NMI Pin" on page 77, "SMI# Pin" on page 78, "INIT# Pin" on page 76, "A20M# Pin" on page 73, "FERR Pin" on page 74, "IGNNE# Pin" on page 76, "STPCLK# Pin" on page 79, and "FLUSH# Pin" on page 77.
System Clocks	SYCLK, SYCLK# (Tied to CLKIN/CLKIN# and RSTCLK/RSTCLK#), PLLBYPASSCLK#, PLLBYPASSCLK	See "Advanced 266 FSB AMD Athlon™ XP Processor Model 8 SYCLK and SYCLK# AC Characteristics" on page 24, "Advanced 333 FSB AMD Athlon™ XP Processor Model 8 SYCLK and SYCLK# AC Characteristics" on page 28, Table 14, "SYCLK and SYCLK# DC Characteristics," on page 37, "SYCLK and SYCLK#" on page 78, and "PLL Bypass and Test Pins" on page 77.
Test	PLLBYPASS#, PLLTEST#, PLLMON1, PLLMON2, SCANCLK1, SCANCLK2, SCANSHIFTEN, SCANINTEVAL, ANALOG	See "General AC and DC Characteristics" on page 39, "PLL Bypass and Test Pins" on page 77, "Scan Pins" on page 78, "Analog Pin" on page 73.
Thermal	THERMDA, THERMDC	Table 17, "Thermal Diode Electrical Characteristics," on page 42, and "THERMDA and THERMDC Pins" on page 78.
Miscellaneous	DBREQ#, DBRDY, PWROK	See "General AC and DC Characteristics" on page 39, "DBRDY and DBREQ# Pins" on page 74, "PWROK Pin" on page 77.

8.3 Voltage Identification (VID[4:0])

Table 9 shows the VID[4:0] DC Characteristics. For more information on VID[4:0] DC Characteristics, see “VID[4:0] Pins” on page 78.

Table 9. VID[4:0] DC Characteristics

Parameter	Description	Min	Max
I _{OL}	Output Current Low	6 mA	
V _{OH}	Output High Voltage	–	5.25 V *
Note: * The VID pins are either open circuit or pulled to ground. It is recommended that these pins are not pulled above 5.25 V, which is 5.0 V + 5%.			

8.4 Frequency Identification (FID[3:0])

Table 10 shows the FID[3:0] DC characteristics. For more information, see “FID[3:0] Pins” on page 75.

Table 10. FID[3:0] DC Characteristics

Parameter	Description	Min	Max
I _{OL}	Output Current Low	6 mA	
V _{OH}	Output High Voltage	–	2.625 V *
Note: * The FID pins must not be pulled above this voltage by an external pullup resistor.			

8.5 VCCA AC and DC Characteristics

Table 11 shows the AC and DC characteristics for VCCA. For more information, see “VCCA Pin” on page 78.

Table 11. VCCA AC and DC Characteristics

Symbol	Parameter	Min	Nominal	Max	Units	Notes
V _{VCCA}	VCCA Pin Voltage	2.25	2.5	2.75	V	1
I _{VCCA}	VCCA Pin Current	0		50	mA/GHz	2
Notes: 1. Minimum and Maximum voltages are absolute. No transients below minimum nor above maximum voltages are permitted. 2. Measured at 2.5 V.						

8.6 Decoupling

See the *AMD Athlon™ Processor-Based Motherboard Design Guide*, order# 24363, or contact your local AMD office for information about the decoupling required on the motherboard for use with the AMD Athlon™ XP processor model 8.

8.7 V_{CC_CORE} Characteristics

Table 12 shows the AC and DC characteristics for V_{CC_CORE}. See Figure 10 on page 35 for a graphical representation of the V_{CC_CORE} waveform.

Table 12. V_{CC_CORE} AC and DC Characteristics

Symbol	Parameter	Limit in Working State	Units
V _{CC_CORE_DC_MAX}	Maximum static voltage above V _{CC_CORE_NOM} *	50	mV
V _{CC_CORE_DC_MIN}	Maximum static voltage below V _{CC_CORE_NOM} *	-50	mV
V _{CC_CORE_AC_MAX}	Maximum excursion above V _{CC_CORE_NOM} *	150	mV
V _{CC_CORE_AC_MIN}	Maximum excursion below V _{CC_CORE_NOM} *	-100	mV
t _{MAX_AC}	Maximum excursion time for AC transients	10	μs
t _{MIN_AC}	Negative excursion time for AC transients	5	μs
Note: * All voltage measurements are taken differentially at the COREFB/COREFB# pins.			

Figure 10 shows the processor core voltage (V_{CC_CORE}) waveform response to perturbation. The t_{min_AC} (negative AC transient excursion time) and t_{max_AC} (positive AC transient excursion time) represent the maximum allowable time below or above the DC tolerance thresholds.

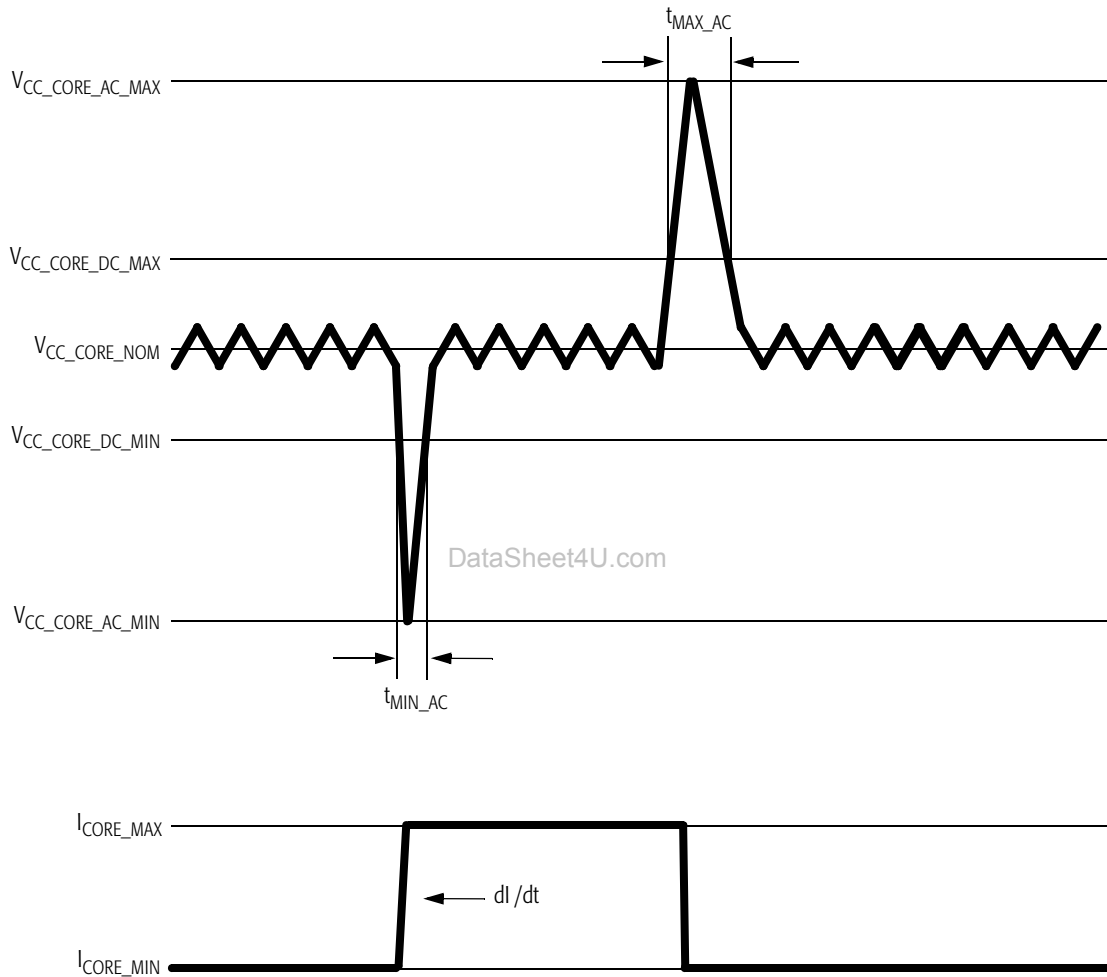

Figure 10. V_{CC_CORE} Voltage Waveform

8.8 Absolute Ratings

The AMD Athlon XP processor model 8 should not be subjected to conditions exceeding the absolute ratings, as such conditions can adversely affect long-term reliability or result in functional damage.

Table 13 lists the maximum absolute ratings of operation for the AMD Athlon XP processor model 8.

Table 13. Absolute Ratings

Parameter	Description	Min	Max
V _{CC_CORE}	AMD Athlon™ XP processor model 8 core supply	–0.5 V	V _{CC_CORE} Max + 0.5 V
V _{CCA}	AMD Athlon XP processor model 8 PLL supply	–0.5 V	V _{CCA} Max + 0.5 V
V _{PIN}	Voltage on any signal pin	–0.5 V	V _{CC_CORE} Max + 0.5 V
T _{STORAGE}	Storage temperature of processor	–40°C	100°C

8.9 SYSCLK and SYSCLK# DC Characteristics

Table 14 shows the DC characteristics of the SYSCLK and SYSCLK# differential clocks. The SYSCLK signal represents CLKIN and RSTCLK tied together while the SYSCLK# signal represents CLKIN# and RSTCLK# tied together. For information about SYSCLK and SYSCLK#, see “SYSCLK and SYSCLK#” on page 79 and Table 24, “Pin Name Abbreviations,” on page 58.

Table 14. SYSCLK and SYSCLK# DC Characteristics

Symbol	Description	Min	Max	Units
$V_{\text{Threshold-DC}}$	Crossing before transition is detected (DC)	400		mV
$V_{\text{Threshold-AC}}$	Crossing before transition is detected (AC)	450		mV
$I_{\text{LEAK_P}}$	Leakage current through P-channel pullup to $V_{\text{CC_CORE}}$	-1		mA
$I_{\text{LEAK_N}}$	Leakage current through N-channel pulldown to VSS (Ground)		1	mA
V_{CROSS}	Differential signal crossover		$V_{\text{CC_CORE}}/2 \pm 100$	mV
C_{PIN}	Capacitance *	4	25 *	pF

Note:
 * The following processor inputs have twice the listed capacitance because they connect to two input pads—SYSCLK and SYSCLK#. SYSCLK connects to CLKIN/RSTCLK. SYSCLK# connects to CLKIN#/RSTCLK#.

Figure 11 shows the DC characteristics of the SYSCLK and SYSCLK# signals.

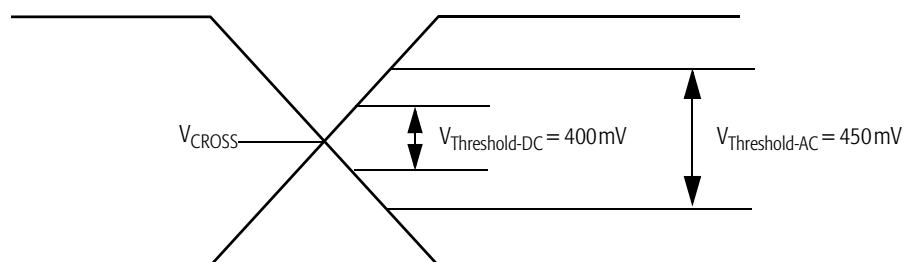

Figure 11. SYSCLK and SYSCLK# Differential Clock Signals

8.10 AMD Athlon™ System Bus DC Characteristics

Table 15 shows the DC characteristics of the AMD Athlon system bus used by the AMD Athlon XP processor model 8.

Table 15. AMD Athlon™ System Bus DC Characteristics

Symbol	Parameter	Condition	Min	Max	Units	Notes
V_{REF}	DC Input Reference Voltage		$(0.5 \times V_{CC_CORE})$ -50	$(0.5 \times V_{CC_CORE})$ +50	mV	1
$I_{VREF_LEAK_P}$	V_{REF} Tristate Leakage Pullup	$V_{IN} = V_{REF}$ Nominal	-100		μ A	
$I_{VREF_LEAK_N}$	V_{REF} Tristate Leakage Pulldown	$V_{IN} = V_{REF}$ Nominal		100	μ A	
V_{IH}	Input High Voltage		$V_{REF} + 200$	$V_{CC_CORE} + 500$	mV	
V_{IL}	Input Low Voltage		-500	$V_{REF} - 200$	mV	
I_{LEAK_P}	Tristate Leakage Pullup	$V_{IN} = V_{SS}$ (Ground)	-1		mA	
I_{LEAK_N}	Tristate Leakage Pulldown	$V_{IN} = V_{CC_CORE}$ Nominal		1	mA	
C_{IN}	Input Pin Capacitance		4	7	pF	
R_{ON}	Output Resistance		$0.90 \times R_{setN,P}$	$1.1 \times R_{setN,P}$	Ω	2
R_{setP}	Impedance Set Point, P Channel		40	70	Ω	2
R_{setN}	Impedance Set Point, N Channel		40	70	Ω	2

Notes:

- V_{REF} is nominally set to 50% of V_{CC_CORE} with actual values that are specific to motherboard design implementation. V_{REF} must be created with a sufficiently accurate DC source and a sufficiently quiet AC response to adhere to the ± 50 mV specification listed above.
- Measured at $V_{CC_CORE} / 2$.

8.11 General AC and DC Characteristics

Table 16 shows the AMD Athlon XP processor model 8 AC and DC characteristics of the Southbridge, JTAG, test, and miscellaneous pins.

Table 16. General AC and DC Characteristics

Symbol	Parameter Description	Condition	Min	Max	Units	Notes
V _{IH}	Input High Voltage		(V _{CC_CORE} /2) + 200 mV	V _{CC_CORE} + 300 mV	V	1, 2
V _{IL}	Input Low Voltage		-300	350	mV	1, 2
V _{OH}	Output High Voltage		V _{CC_CORE} - 400	V _{CC_CORE} + 300	mV	
V _{OL}	Output Low Voltage		-300	400	mV	
I _{LEAK_P}	Tristate Leakage Pullup	V _{IN} = VSS (Ground)	-1		mA	
I _{LEAK_N}	Tristate Leakage Pulldown	V _{IN} = V _{CC_CORE} Nominal		600	μA	
I _{OH}	Output High Current			-6	mA	3
I _{OL}	Output Low Current		6		mA	3
T _{SU}	Sync Input Setup Time		2.0		ns	4, 5
T _{HD}	Sync Input Hold Time		0.0		ps	4, 5
T _{DELAY}	Output Delay with respect to RSTCLK		0.0	6.1	ns	5

Notes:

1. Characterized across DC supply voltage range.
2. Values specified at nominal V_{CC_CORE}. Scale parameters between V_{CC_CORE} minimum and V_{CC_CORE} maximum.
3. I_{OL} and I_{OH} are measured at V_{OL} maximum and V_{OH} minimum, respectively.
4. Synchronous inputs/outputs are specified with respect to RSTCLK and RSTCK# at the pins.
5. These are aggregate numbers.
6. Edge rates indicate the range over which inputs were characterized.
7. In asynchronous operation, the signal must persist for this time to enable capture.
8. This value assumes RSTCLK period is 10 ns ⇒ TBIT = 2*FRST.
9. The approximate value for standard case in normal mode operation.
10. This value is dependent on RSTCLK frequency, divisors, Low Power mode, and core frequency.
11. Reassertions of the signal within this time are not guaranteed to be seen by the core.
12. This value assumes that the skew between RSTCLK and K7CLKOUT is much less than one phase.
13. This value assumes RSTCLK and K7CLKOUT are running at the same frequency, though the processor is capable of other configurations.
14. Time to valid is for any open-drain pins. See requirements 7 and 8 in the "Power-Up Timing Requirements" chapter for more information.

Table 16. General AC and DC Characteristics (continued)

Symbol	Parameter Description	Condition	Min	Max	Units	Notes
T _{BIT}	Input Time to Acquire		20.0		ns	7, 8
T _{RPT}	Input Time to Reacquire		40.0		ns	9–13
T _{RISE}	Signal Rise Time		1.0	3.0	V/ns	6
T _{FALL}	Signal Fall Time		1.0	3.0	V/ns	6
C _{PIN}	Pin Capacitance		4	12	pF	
T _{VALID}	Time to data valid			100	ns	14

Notes:

1. Characterized across DC supply voltage range.
2. Values specified at nominal V_{CC_CORE}. Scale parameters between V_{CC_CORE} minimum and V_{CC_CORE} maximum.
3. I_{OL} and I_{OH} are measured at V_{OL} maximum and V_{OH} minimum, respectively.
4. Synchronous inputs/outputs are specified with respect to RSTCLK and RSTCK# at the pins.
5. These are aggregate numbers.
6. Edge rates indicate the range over which inputs were characterized.
7. In asynchronous operation, the signal must persist for this time to enable capture.
8. This value assumes RSTCLK period is 10 ns ⇒ T_{BIT} = 2*f_{RST}.
9. The approximate value for standard case in normal mode operation.
10. This value is dependent on RSTCLK frequency, divisors, Low Power mode, and core frequency.
11. Reassertions of the signal within this time are not guaranteed to be seen by the core.
12. This value assumes that the skew between RSTCLK and K7CLKOUT is much less than one phase.
13. This value assumes RSTCLK and K7CLKOUT are running at the same frequency, though the processor is capable of other configurations.
14. Time to valid is for any open-drain pins. See requirements 7 and 8 in the "Power-Up Timing Requirements" chapter for more information.

8.12 Open-Drain Test Circuit

Figure 12 is a test circuit that may be used on automated test equipment (ATE) to test for validity on open drain pins.

Refer to Table 16, “General AC and DC Characteristics,” on page 39 for timing requirements.

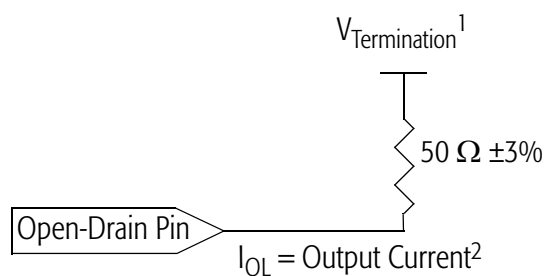

Notes:

1. $V_{Termination} = 1.2\text{ V}$ for VID and FID pins
 $V_{Termination} = 1.0\text{ V}$ for APIC pins
2. $I_{OL} = -6\text{ mA}$ for VID and FID pins
 $I_{OL} = -9\text{ mA}$ for APIC pins

Figure 12. General ATE Open-Drain Test Circuit

8.13 Thermal Diode Characteristics

The AMD Athlon XP processor model 8 provides a diode that can be used in conjunction with an external temperature sensor to determine the die temperature of the processor. The diode anode (THERMDA) and cathode (THERMDC) are available as pins on the processor, as described in “THERMDA and THERMDC Pins” on page 78.

For information about thermal design for the AMD Athlon XP processor model 8, including layout and airflow considerations, see the *AMD Processor Thermal, Mechanical, and Chassis Cooling Design Guide*, order# 23794, and the cooling guidelines on <http://www.amd.com>.

Thermal Diode Electrical Characteristics

Table 17 shows the AMD Athlon XP processor model 8 characteristics of the on-die thermal diode. For information about calculations for the ideal diode equation and temperature offset correction, see Appendix A, "Thermal Diode Calculations," on page 77.

Table 17. Thermal Diode Electrical Characteristics

Symbol	Parameter Description	Min	Nom	Max	Units	Notes
I	Sourcing current	5		300	μA	1
n_f , lumped	Lumped ideality factor	1.00000	1.00374	1.00900		2, 3, 4
n_f , actual	Actual ideality factor		1.00261			3, 4
R_T	Series Resistance		0.93		Ω	3, 4

Notes:

1. The sourcing current should always be used in forward bias only.
2. Characterized at 95°C with a forward bias current pair of 10 μA and 100 μA. AMD recommends using a minimum of two sourcing currents to accurately measure the temperature of the thermal diode.
3. Not 100% tested. Specified by design and limited characterization.
4. The lumped ideality factor adds the effect of the series resistance term to the actual ideality factor. The series resistance term indicates the resistance from the pins of the processor to the on-die thermal diode. The value of the lumped ideality factor depends on the sourcing current pair used.

Thermal Protection Characterization

The following section describes parameters relating to thermal protection. The implementation of thermal control circuitry to control processor temperature is left to the manufacturer to determine how to implement.

Thermal limits in motherboard design are necessary to protect the processor from thermal damage. T_{SHUTDOWN} is the temperature for thermal protection circuitry to initiate shutdown of the processor. $T_{\text{SD_DELAY}}$ is the maximum time allowed from the detection of the over-temperature condition to processor shutdown to prevent thermal damage to the processor.

Systems that do not implement thermal protection circuitry or that do not react within the time specified by $T_{\text{SD_DELAY}}$ can cause thermal damage to the processor during the unlikely events of fan failure or powering up the processor without a heat-sink. The processor relies on thermal circuitry on the motherboard to turn off the regulated core voltage to the processor in response to a thermal shutdown event.

Thermal protection circuitry reference designs and thermal solution guidelines are found in the following documents:

- *AMD Athlon™ Processor-Based Motherboard Design Guide*, order# 24363
- *AMD Thermal, Mechanical, and Chassis Cooling Design Guide*, order# 23794

See <http://www.amd.com> for more information about thermal solutions.

Table 18 on page 44 shows the T_{SHUTDOWN} and $T_{\text{SD_DELAY}}$ specifications for circuitry in motherboard design necessary for thermal protection of the processor.

Table 18. Guidelines for Platform Thermal Protection of the Processor

Symbol	Parameter Description	Max	Units	Notes
T _{SHUTDOWN}	Thermal diode shutdown temperature for processor protection	125	°C	1, 2, 3
T _{SD_DELAY}	Maximum allowed time from T _{SHUTDOWN} detection to processor shutdown	500	ms	1, 3

Notes:

1. The thermal diode is not 100% tested, it is specified by design and limited characterization.
2. The thermal diode is capable of responding to thermal events of 40°C/s or faster.
3. The AMD Athlon™ XP processor model 8 provides a thermal diode for measuring die temperature of the processor. The processor relies on thermal circuitry on the motherboard to turn off the regulated core voltage to the processor in response to a thermal shutdown event. Refer to AMD Athlon™ Processor-Based Motherboard Design Guide, order# 24363, for thermal protection circuitry designs.

8.14 APIC Pins AC and DC Characteristics

Table 19 shows the AMD Athlon XP processor model 8 AC and DC characteristics of the APIC pins.

Table 19. APIC Pin AC and DC Characteristics

Symbol	Parameter Description	Condition	Min	Max	Units	Notes
V _{IH}	Input High Voltage		1.7	2.625	V	1, 2
V _{IL}	Input Low Voltage		-300	700	mV	1
V _{OH}	Output High Voltage			2.625	V	2
V _{OL}	Output Low Voltage		-300	400	mV	
I _{LEAK_P}	Tristate Leakage Pullup	V _{IN} = VSS (Ground)	-1		mA	
I _{LEAK_N}	Tristate Leakage Pulldown	V _{IN} = 2.5 V		1	mA	
I _{OL}	Output Low Current	V _{OL} Max	9		mA	
T _{RISE}	Signal Rise Time		1.0	3.0	V/ns	3
T _{FALL}	Signal Fall Time		1.0	3.0	V/ns	3
T _{SU}	Setup Time		1		ns	
T _{HD}	Hold Time		1		ns	
C _{PIN}	Pin Capacitance		4	12	pF	

Notes:

1. Characterized across DC supply voltage range.
2. The 2.625-V value is equal to 2.5 V plus a maximum of five percent.
3. Edge rates indicate the range for characterizing the inputs.

9 Signal and Power-Up Requirements

The AMD Athlon™ XP processor model 8 is designed to provide functional operation if the voltage and temperature parameters are within the limits of normal operating ranges.

9.1 Power-Up Requirements

Signal Sequence and Timing Description

Figure 13 shows the relationship between key signals in the system during a power-up sequence. This figure details the requirements of the processor.

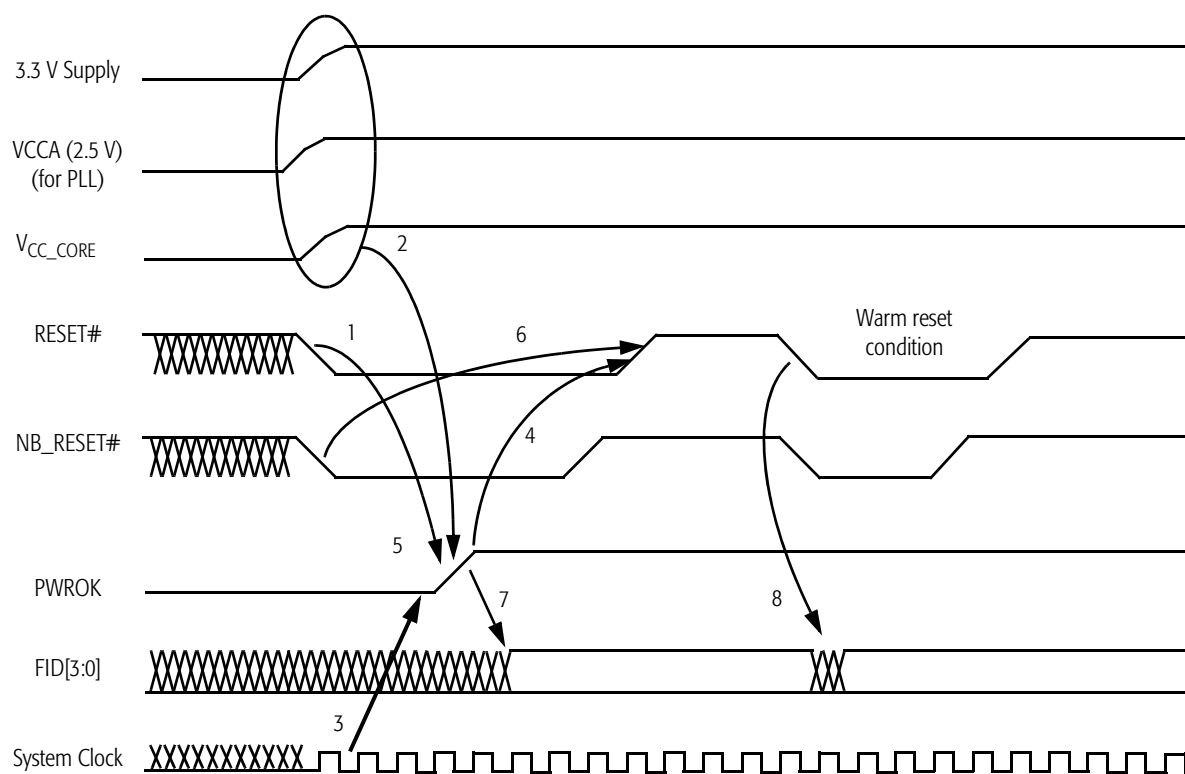

Figure 13. Signal Relationship Requirements During Power-Up Sequence

Notes: 1. Figure 13 represents several signals generically by using names not necessarily consistent with any pin lists or schematics.

2. Requirements 1–8 in Figure 13 are described in “Power-Up Timing Requirements” on page 46.

Power-Up Timing Requirements. The signal timing requirements are as follows:

1. RESET# must be asserted before PWROK is asserted.

The AMD Athlon XP processor model 8 does not set the correct clock multiplier if PWROK is asserted prior to a RESET# assertion. It is recommended that RESET# be asserted at least **10 nanoseconds** prior to the assertion of PWROK.

In practice, a Southbridge asserts RESET# milliseconds before PWROK is asserted.

2. All motherboard voltage planes must be within specification before PWROK is asserted.

PWROK is an output of the voltage regulation circuit on the motherboard. PWROK indicates that V_{CC_CORE} and all other voltage planes in the system are within specification.

The motherboard is required to delay PWROK assertion for a minimum of three milliseconds from the 3.3 V supply being within specification. This delay ensures that the system clock (SYSCLK/SYSCLK#) is operating within specification when PWROK is asserted.

The processor core voltage, V_{CC_CORE} , must be within specification as dictated by the VID[4:0] pins driven by the processor before PWROK is asserted. Before PWROK assertion, the AMD Athlon processor is clocked by a ring oscillator.

The processor PLL is powered by VCCA. The processor PLL does not lock if VCCA is not high enough for the processor logic to switch for some period before PWROK is asserted. VCCA must be within specification at least five microseconds before PWROK is asserted.

In practice VCCA, V_{CC_CORE} , and all other voltage planes must be within specification for several milliseconds before PWROK is asserted.

After PWROK is asserted, the processor PLL locks to its operational frequency.

3. The system clock (SYSCLK/SYSCLK#) must be running before PWROK is asserted.

When PWROK is asserted, the processor switches from driving the internal processor clock grid from the ring oscillator to driving from the PLL. The reference system

clock must be valid at this time. The system clocks are designed to be running after 3.3 V has been within specification for three milliseconds.

4. PWROK assertion to deassertion of RESET#

The duration of RESET# assertion during cold boots is intended to satisfy the time it takes for the PLL to lock with a less than 1 ns phase error. The processor PLL begins to run after PWROK is asserted and the internal clock grid is switched from the ring oscillator to the PLL. The PLL lock time may take from hundreds of nanoseconds to tens of microseconds. It is recommended that the minimum time between PWROK assertion to the deassertion of RESET# be at least **1.0 milliseconds**. Southbridges enforce a delay of 1.5 to 2.0 milliseconds between PWRGD (Southbridge version of PWROK) assertion and NB_RESET# deassertion.

5. PWROK must be monotonic and meet the timing requirements as defined in Table 16, “General AC and DC Characteristics,” on page 39. The processor should not switch between the ring oscillator and the PLL after the initial assertion of PWROK.

6. NB_RESET# must be asserted (causing CONNECT to also assert) before RESET# is deasserted. In practice all Southbridges enforce this requirement.

If NB_RESET# does not assert until after RESET# has deasserted, the processor misinterprets the CONNECT assertion (due to NB_RESET# being asserted) as the beginning of the SIP transfer. There must be sufficient overlap in the resets to ensure that CONNECT is sampled asserted by the processor before RESET# is deasserted.

7. The FID[3:0] signals are valid within 100 ns after PWROK is asserted. The chipset must not sample the FID[3:0] signals until they become valid. Refer to the *AMD Athlon™ Processor-Based Motherboard Design Guide*, order# 24363, for the specific implementation and additional circuitry required.

8. The FID[3:0] signals become valid within 100 ns after RESET# is asserted. Refer to the *AMD Athlon™ Processor-Based Motherboard Design Guide*, order# 24363, for the specific implementation and additional circuitry required.

Clock Multiplier Selection (FID[3:0])

The chipset samples the FID[3:0] signals in a chipset-specific manner from the processor and uses this information to determine the correct serial initialization packet (SIP). The chipset then sends the SIP information to the processor for configuration of the AMD Athlon system bus for the clock multiplier that determines the processor frequency indicated by the FID[3:0] code. The SIP is sent to the processor using the SIP protocol. This protocol uses the PROCRDY, CONNECT, and CLKFWDRST signals, that are synchronous to SYCLK.

For more information about FID[3:0], see “FID[3:0] Pins” on page 75.

Serial Initialization Packet (SIP) Protocol. Refer to *AMD Athlon™ System Bus Specification*, order# 21902 for details of the SIP protocol.

9.2 Processor Warm Reset Requirements

Northbridge Reset Pins

RESET# cannot be asserted to the processor without also being asserted to the Northbridge. RESET# to the Northbridge is the same as PCI RESET#. The minimum assertion for PCI RESET# is one millisecond. Southbridges enforce a minimum assertion of RESET# for the processor, Northbridge, and PCI of 1.5 to 2.0 milliseconds.

10 Mechanical Data

The AMD Athlon™ XP processor model 8 connects to the motherboard through a Pin Grid Array (PGA) socket named Socket A. This processor utilizes the organic pin grid array (OPGA) package type described in this chapter. For more information, see the *AMD Athlon™ Processor-Based Motherboard Design Guide*, order# 24363.

10.1 Die Loading

The processor die on the OPGA package is exposed at the top of the package. This feature facilitates heat transfer from the die to an approved heat sink. Any heat sink design should avoid loads on corners and edges of die. The OPGA package has compliant pads that serve to bring surfaces in planar contact. Tool-assisted zero insertion force sockets should be designed so that no load is placed on the substrate of the package.

Table 20 shows the mechanical loading specifications for the processor die. It is critical that the mechanical loading of the heat sink does not exceed the limits shown in Table 20.

Table 20. Mechanical Loading

Location	Dynamic (MAX)	Static (MAX)	Units	Note
Die Surface	100	30	lbf	1
Die Edge	10	10	lbf	2
Notes:				
1. Load specified for coplanar contact to die surface.				
2. Load defined for a surface at no more than a two-degree angle of inclination to die surface.				

10.2 Part Number 27291 OPGA Package Dimensions for AMD Athlon™ XP Processors Model 8 with a CPUID of 680

For AMD Athlon XP processors model 8 with a CPUID of 680, Table 21 shows the 27291 OPGA package dimensions in millimeters assigned to the letters and symbols used in the 27291 package diagram, Figure 14 on page 52.

Table 21. Part Number 27291 OPGA Package Dimensions for AMD Athlon™ XP Processors Model 8 with a CPUID of 680

Letter or Symbol	Minimum Dimension ¹	Maximum Dimension ¹	Letter or Symbol	Minimum Dimension ¹	Maximum Dimension ¹
D/E	49.27	49.78	E9	1.66	1.96
D1/E1	45.72 BSC		G/H	–	4.50
D2	7.31 REF		A	1.942 REF	
D3	3.30	3.60	A1	1.00	1.20
D4	10.78	11.33	A2	0.80	0.88
D5	10.78	11.33	A3	0.116	–
D6	8.13	8.68	A4	–	1.90
D7	12.33	12.88	φP	–	6.60
D8	3.05	3.35	φb	0.43	0.50
D9	12.71	13.26	φb1	1.40 REF	
E2	11.06 REF		S	1.435	2.375
E3	2.35	2.65	L	3.05	3.31
E4	7.87	8.42	M	37	
E5	7.87	8.42	N	453	
E6	10.73	11.28	e	1.27 BSC	
E7	10.73	11.28	e1	2.54 BSC	
E8	13.28	13.83	Mass ²	11.0 g REF	
Note:					
1. Dimensions are given in millimeters.					
2. The mass consists of the completed package, including processor, surface mounted parts, and pins.					

10.3 Part Number 27291 OPGA Package Dimensions for AMD Athlon™ XP Processors Model 8 with a CPUID of 681

For AMD Athlon XP processors model 8 with a CPUID of 681, Table 22 shows the 27291 OPGA package dimensions in millimeters assigned to the letters and symbols used in the 27291 package diagram, Figure 14 on page 52.

Table 22. Part Number 27291 OPGA Package Dimensions for AMD Athlon™ XP Processors Model 8 with a CPUID of 681

Letter or Symbol	Minimum Dimension ¹	Maximum Dimension ¹	Letter or Symbol	Minimum Dimension ¹	Maximum Dimension ¹
D/E	49.27	49.78	E9	1.66	1.96
D1/E1	45.72 BSC		G/H	–	4.50
D2	7.47 REF		A	1.942 REF	
D3	3.30	3.60	A1	1.00	1.20
D4	10.78	11.33	A2	0.80	0.88
D5	10.78	11.33	A3	0.116	–
D6	8.13	8.68	A4	–	1.90
D7	12.33	12.88	φP	–	6.60
D8	3.05	3.35	φb	0.43	0.50
D9	12.71	13.26	φb1	1.40 REF	
E2	11.33 REF		S	1.435	2.375
E3	2.35	2.65	L	3.05	3.31
E4	7.87	8.42	M	37	
E5	7.87	8.42	N	453	
E6	10.73	11.28	e	1.27 BSC	
E7	10.73	11.28	e1	2.54 BSC	
E8	13.28	13.83	Mass ²	11.0 g REF	
Note:					
1. Dimensions are given in millimeters.					
2. The mass consists of the completed package, including processor, surface mounted parts, and pins.					

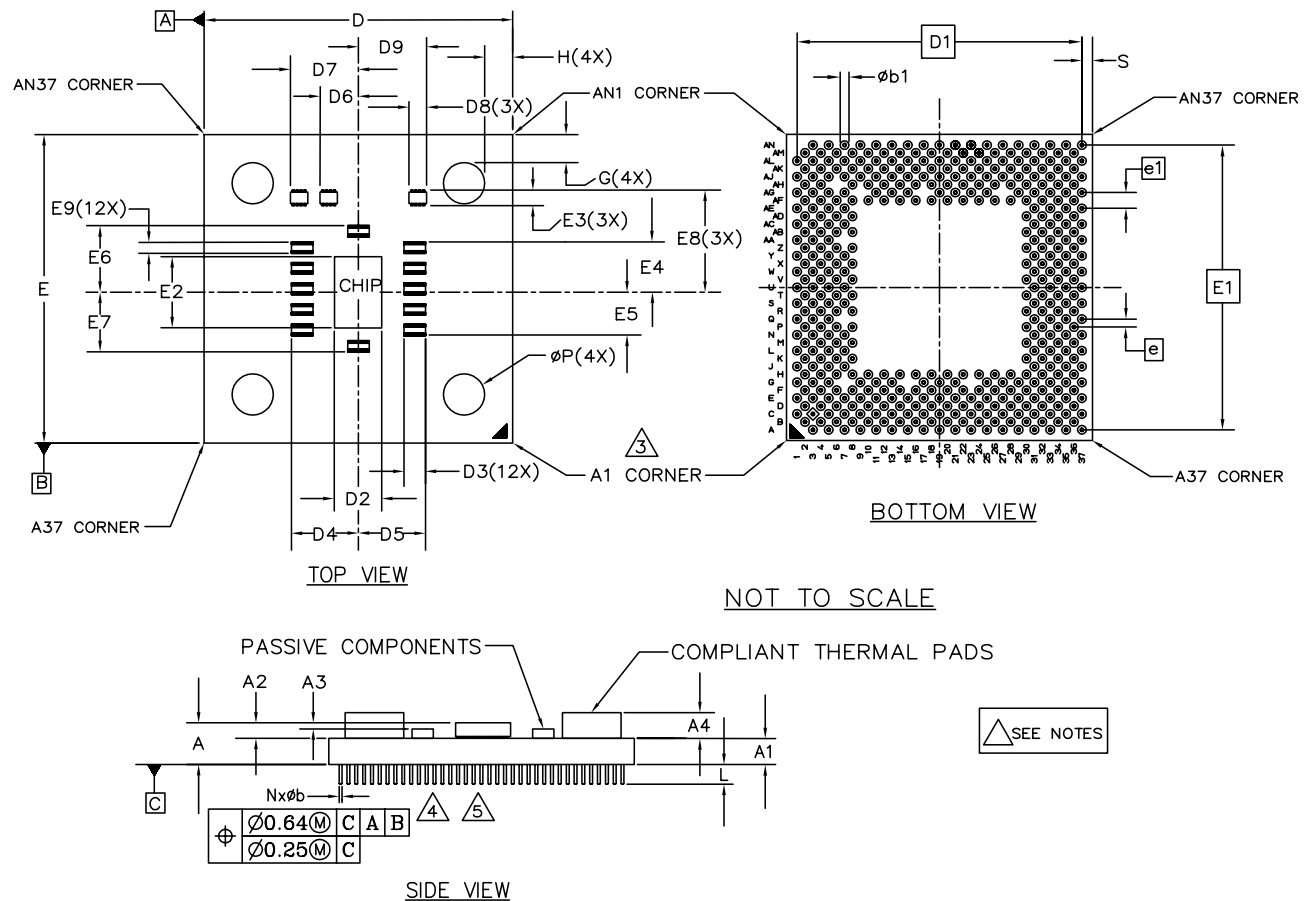

GENERAL NOTES:

- All dimensions are specified in millimeter (mm).
- Dimensioning and tolerancing per ASME-Y14.5M-1994.
- This corner is marked with a triangle on both sides of the package to identify the pin A1 corner for orientation purposes.
- Pin tips should have radius.
- Symbol "M" determines pin matrix size and "N" is number of pins.
- For staggered pin configuration, pins on the same row are on a 2.54 mm grid. Adjacent rows offset by 1.27 mm.

Figure 14. AMD Athlon™ XP Processor Model 8 Part Number 27291 OPGA Package

10.4 Part Number 27648 OPGA Package Dimensions for AMD Athlon™ XP Processors Model 8 with a CPUID of 681

For AMD Athlon XP processors model 8 with a CPUID of 681, Table 23 shows the part number 27648 OPGA package dimensions in millimeters assigned to the letters and symbols used in the 27648 package diagram, Figure 15 on page 54.

Table 23. Part Number 27648 OPGA Package Dimensions for AMD Athlon™ XP Processors Model 8 with a CPUID of 681

Letter or Symbol	Minimum Dimension ¹	Maximum Dimension ¹	Letter or Symbol	Minimum Dimension ¹	Maximum Dimension ¹
D/E	49.27	49.78	G/H	–	4.50
D1/E1	45.72 BSC		A	1.917 REF	
D2	7.47 REF		A1	0.977	1.177
D3	3.30	3.60	A2	0.80	0.88
D4	10.78	11.33	A3	0.116	–
D5	10.78	11.33	A4	–	1.90
D6	8.13	8.68	φP	–	6.60
D7	12.33	12.88	φb	0.43	0.50
D8	3.05	3.35	φb1	1.40 REF	
D9	12.71	13.26	S	1.435	2.375
E2	11.33 REF		L	3.05	3.31
E3	2.35	2.65	M	37	
E4	7.87	8.42	N	453	
E5	7.87	8.42	e	1.27 BSC	
E6	10.73	11.28	e1	2.54 BSC	
E8	13.28	13.83	Mass ²	11.0 g REF	
E9	1.66	1.96			
Note:					
1. Dimensions are given in millimeters.					
2. The mass consists of the completed package, including processor, surface mounted parts, and pins.					

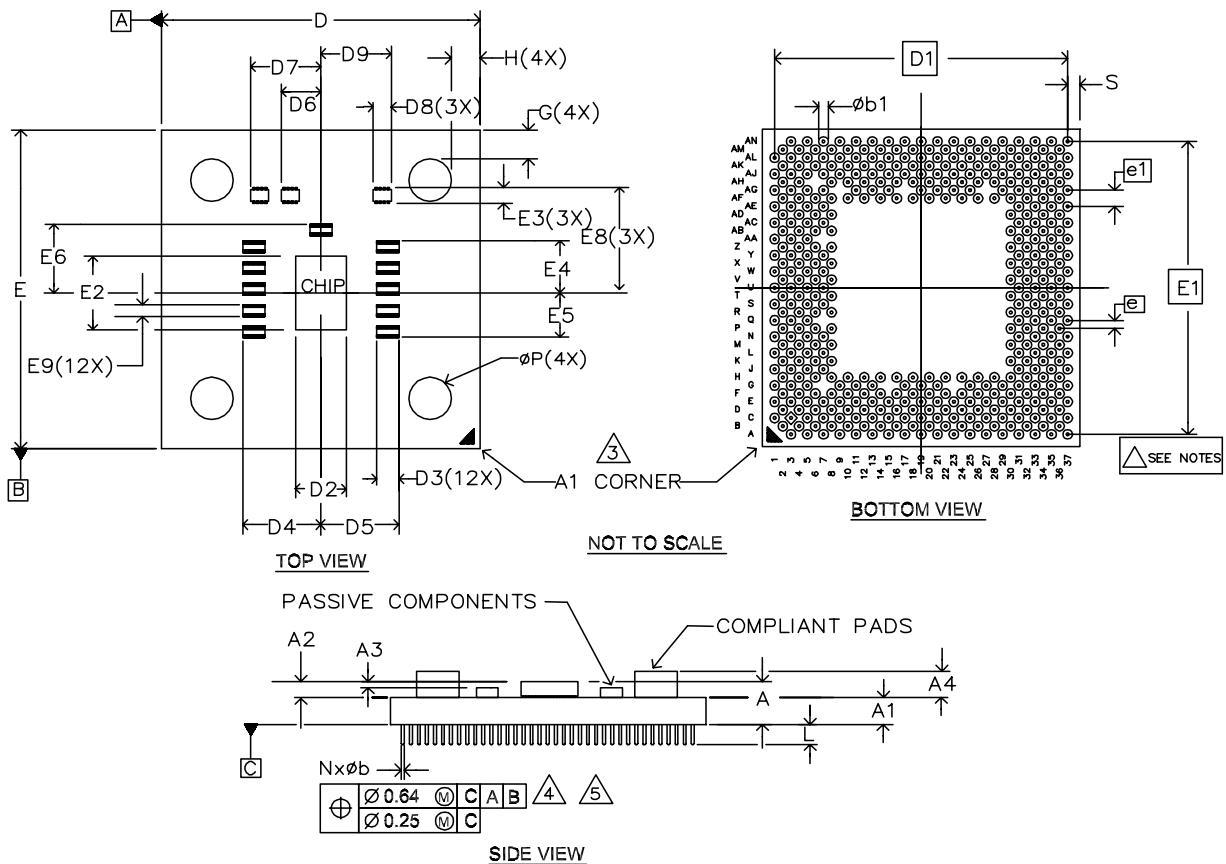

GENERAL NOTES

1. All dimensions are specified in millimeters (mm).
2. Dimensioning and tolerancing per ASME-Y14.5M-1994.
3. This corner is marked with a triangle on both sides of the package identifies pin A1 corner and can be used for handling and orientation purposes.
4. Pin tips should have radius.
5. Symbol "M" determines pin matrix size and "N" is number of pins.
6. "x" in front of package variation denotes non-qualified package per AMD 01-002.3.
7. The following features are not shown on drawings:
 - a) Marking on die, label on package
 - b) Laser elements
 - c) Die and passive fiducials
8. The die is centered on the package.

Figure 15. AMD Athlon™ XP Processor Model 8 Part Number 27648 OPGA Package

11 Pin Descriptions

This chapter includes pin diagrams of the organic pin grid array (OPGA) for the AMD Athlon™ XP processor model 8, a listing of pin name abbreviations, and a cross-referenced listing of pin locations to signal names.

11.1 Pin Diagram and Pin Name Abbreviations

Figure 16 on page 56 shows the staggered pin grid array (PGA) for the AMD Athlon™ XP processor model 8. Because some of the pin names are too long to fit in the grid, they are abbreviated. Figure 17 on page 57 shows the bottomside view of the array. Table 24 on page 58 lists all the pins in alphabetical order by pin name, along with the abbreviation where necessary.

	1	2	3	4	5	6	7	8	9	10	11	12	13	14	15	16	17	18	19	20	21	22	23	24	25	26	27	28	29	30	31	32	33	34	35	36	37						
A			SA0P12	SA0H5	SA0H8	VSS	SA0H9	SA0H7	SA0F55	SA0M1	SA0F53	SA0F63	SA0F62	SA0F61	SA0F62	SA0F61	SA0F62	SA0F61	SA0F62	SA0F61	SA0F62	SA0F61	SA0F62	SA0F61	SA0F62	SA0F61	SA0F62	SA0F61	SA0F62	SA0F61	SA0F62	SA0F61	SA0F62	SA0F61	SA0F62	SA0F61	SA0F62	SA0F61	SA0F62				
B		VSS		VCC	VSS	VSS		VCC		VSS	VCC	VSS	VCC	VSS	VCC	VSS	VCC	VSS	VCC	VSS	VCC	VSS	VCC	VSS	VCC	VSS	VCC	VSS	VCC	VSS	VCC	VSS	VCC	VSS	VCC	VSS	VCC	VSS	VCC				
C	SA0P7	SA0H9	SA0H9	SA0H8	SA0H8	SA0H2	SA0H2	SA0H6	SA0F54	SA0C63	SA0C63	SA0C63	SA0H60	SA0F59	SA0F56	SA0F57	SA0F57	SA0F58	SA0F59	SA0F56	SA0F57	SA0F58	SA0F59	SA0F56	SA0F57	SA0F58	SA0F59	SA0F56	SA0F57	SA0F58	SA0F59	SA0F56	SA0F57	SA0F58	SA0F59	SA0F56	SA0F57	SA0F58	SA0F59	SA0F56	SA0F57	SA0F58	SA0F59
D		VCC	VCC	VCC	VCC	VSS	VSS	VCC	SA0F52	SA0C63	SA0C63	SA0C63	SA0H48	SA0F59	SA0F56	SA0F57	SA0F57	SA0F58	SA0F59	SA0F56	SA0F57	SA0F58	SA0F59	SA0F56	SA0F57	SA0F58	SA0F59	SA0F56	SA0F57	SA0F58	SA0F59	SA0F56	SA0F57	SA0F58	SA0F59	SA0F56	SA0F57	SA0F58	SA0F59	SA0F56	SA0F57	SA0F58	SA0F59
E	SA0P11		SA0C6F	SA0H4	SA0H4	VSS	SA0H6		SA0F52	SA0C63	SA0C63	SA0C63	SA0H48	SA0F59	SA0F56	SA0F57	SA0F57	SA0F58	SA0F59	SA0F56	SA0F57	SA0F58	SA0F59	SA0F56	SA0F57	SA0F58	SA0F59	SA0F56	SA0F57	SA0F58	SA0F59	SA0F56	SA0F57	SA0F58	SA0F59	SA0F56	SA0F57	SA0F58	SA0F59	SA0F56	SA0F57	SA0F58	SA0F59
F		VSS		VSS	VSS	VSS		VCC		VSS	VCC	VSS	VCC	VSS	VCC	VSS	VCC	VSS	VCC	VSS	VCC	VSS	VCC	VSS	VCC	VSS	VCC	VSS	VCC	VSS	VCC	VSS	VCC	VSS	VCC	VSS	VCC	VSS	VCC	VSS	VCC		
G	SA0P10		SA0H14	SA0P13	SA0P13	VCC	SA0H14	KEY	KEY	SA0H14	SA0H14	SA0H14	SA0H14	SA0H14	SA0H14	SA0H14	SA0H14	SA0H14	SA0H14	SA0H14	SA0H14	SA0H14	SA0H14	SA0H14	SA0H14	SA0H14	SA0H14	SA0H14	SA0H14	SA0H14	SA0H14	SA0H14	SA0H14	SA0H14	SA0H14	SA0H14	SA0H14	SA0H14	SA0H14	SA0H14	SA0H14		
H		VCC	VCC	VCC	VCC	VCC	VCC	VCC	VCC	VCC	VCC	VCC	VCC	VCC	VCC	VCC	VCC	VCC	VCC	VCC	VCC	VCC	VCC	VCC	VCC	VCC	VCC	VCC	VCC	VCC	VCC	VCC	VCC	VCC	VCC	VCC	VCC	VCC	VCC	VCC			
J	SA0P0		SA0H1		SA0H1	VID[4]	VID[4]	VID[4]																																			
K		VSS		VSS	VSS	VSS	VSS	VSS	VSS	VSS	VSS	VSS	VSS	VSS	VSS	VSS	VSS	VSS	VSS	VSS	VSS	VSS	VSS	VSS	VSS	VSS	VSS	VSS	VSS	VSS	VSS	VSS	VSS	VSS	VSS	VSS	VSS	VSS	VSS	VSS			
L	VID[0]		VID[1]		VID[2]	VID[3]	VID[3]	VID[3]																																			
M		VCC		VCC	VCC	VCC	VCC	VCC																																			
N	PKCLK		PKCH0		PKCH1	PKCH1	KEY	KEY																																			
P		VSS		VSS	VSS	VSS	VSS	VSS	VSS	VSS	VSS	VSS	VSS	VSS	VSS	VSS	VSS	VSS	VSS	VSS	VSS	VSS	VSS	VSS	VSS	VSS	VSS	VSS	VSS	VSS	VSS	VSS	VSS	VSS	VSS	VSS	VSS	VSS	VSS				
Q	TKC		TMS		SC0SN	SC0SN	KEY	KEY																																			
R		VCC		VCC	VCC	VCC	VCC	VCC	VCC	VCC	VCC	VCC	VCC	VCC	VCC	VCC	VCC	VCC	VCC	VCC	VCC	VCC	VCC	VCC	VCC	VCC	VCC	VCC	VCC	VCC	VCC	VCC	VCC	VCC	VCC	VCC	VCC	VCC					
S	SC0CK1		SC0SN		SC0CK2	TH0A	TH0A	TH0A																																			
T		VSS		VSS	VSS	VSS	VSS	VSS	VSS	VSS	VSS	VSS	VSS	VSS	VSS	VSS	VSS	VSS	VSS	VSS	VSS	VSS	VSS	VSS	VSS	VSS	VSS	VSS	VSS	VSS	VSS	VSS	VSS	VSS	VSS	VSS	VSS	VSS					
U	TDI		TR0S#		TD0	TH0C	TH0C	TH0C																																			
V		VCC		VCC	VCC	VCC	VCC	VCC	VCC	VCC	VCC	VCC	VCC	VCC	VCC	VCC	VCC	VCC	VCC	VCC	VCC	VCC	VCC	VCC	VCC	VCC	VCC	VCC	VCC	VCC	VCC	VCC	VCC	VCC	VCC	VCC	VCC	VCC					
W	FID[0]		FID[1]		WRE0_5		NC	NC																																			
X		VSS		VSS	VSS	VSS	VSS	VSS	VSS	VSS	VSS	VSS	VSS	VSS	VSS	VSS	VSS	VSS	VSS	VSS	VSS	VSS	VSS	VSS	VSS	VSS	VSS	VSS	VSS	VSS	VSS	VSS	VSS	VSS	VSS	VSS	VSS	VSS					
Y	FID[2]		FID[3]		NC	KEY	KEY	KEY																																			
Z		VCC		VCC	VCC	VCC	VCC	VCC	VCC	VCC	VCC	VCC	VCC	VCC	VCC	VCC	VCC	VCC	VCC	VCC	VCC	VCC	VCC	VCC	VCC	VCC	VCC	VCC	VCC	VCC	VCC	VCC	VCC	VCC	VCC	VCC	VCC						
AA	DBRDY		DBREQ#		NC	KEY	KEY	KEY																																			
AB		VSS		VSS	VSS	VSS	VSS	VSS	VSS	VSS	VSS	VSS	VSS	VSS	VSS	VSS	VSS	VSS	VSS	VSS	VSS	VSS	VSS	VSS	VSS	VSS	VSS	VSS	VSS	VSS	VSS	VSS	VSS	VSS	VSS	VSS	VSS						
AC	STPC#		PLT0S#		ZH	NC	NC	NC																																			
AD		VCC		VCC	VCC	VCC	VCC	VCC	VCC	VCC	VCC	VCC	VCC	VCC	VCC	VCC	VCC	VCC	VCC	VCC	VCC	VCC	VCC	VCC	VCC	VCC	VCC	VCC	VCC	VCC	VCC	VCC	VCC	VCC	VCC	VCC	VCC						
AE	AZ0W#		PWR0K		ZP	NC	NC	NC																																			
AF		VSS		VSS	VSS	VSS	VSS	VSS	VSS	VSS	VSS	VSS	VSS	VSS	VSS	VSS	VSS	VSS	VSS	VSS	VSS	VSS	VSS	VSS	VSS	VSS	VSS	VSS	VSS	VSS	VSS	VSS	VSS	VSS	VSS	VSS	VSS						
AG	FERR		RESET#		NC	KEY	KEY	KEY	KEY	KEY	KEY	KEY	KEY	KEY	KEY	KEY	KEY	KEY	KEY	KEY	KEY	KEY	KEY	KEY	KEY	KEY	KEY	KEY	KEY	KEY	KEY	KEY	KEY	KEY	KEY	KEY	KEY						
AH		VCC		VCC	VCC	VCC	VCC	VCC	VCC	VCC	VCC	VCC	VCC	VCC	VCC	VCC	VCC	VCC	VCC	VCC	VCC	VCC	VCC	VCC	VCC	VCC	VCC	VCC	VCC	VCC	VCC	VCC	VCC	VCC	VCC	VCC	VCC						
AJ	IG0W#		INT#		VCC	CPH	NC	NC	NC	NC	NC	NC	NC	NC	NC	NC	NC	NC	NC	NC	NC	NC	NC	NC	NC	NC	NC	NC	NC	NC	NC	NC	NC	NC	NC	NC	NC						
AK		VSS		VSS	VSS	VSS	VSS	VSS	VSS	VSS	VSS	VSS	VSS	VSS	VSS	VSS	VSS	VSS	VSS	VSS	VSS	VSS	VSS	VSS	VSS	VSS	VSS	VSS	VSS	VSS	VSS	VSS	VSS	VSS	VSS	VSS	VSS						
AL	INTR		FLUSH#		VCC	VCC	NC	NC	NC	NC	NC	NC	NC	NC	NC	NC	NC	NC	NC	NC	NC	NC	NC	NC	NC	NC	NC	NC	NC	NC	NC	NC	NC	NC	NC	NC	NC						
AM		VCC		VCC	VSS	VSS	VSS	VSS	VSS	VSS	VSS	VSS	VSS	VSS	VSS	VSS	VSS	VSS	VSS	VSS	VSS	VSS	VSS	VSS	VSS	VSS	VSS	VSS	VSS	VSS	VSS	VSS	VSS	VSS	VSS	VSS	VSS						
AN			NMI		SM#	NC	NC	NC	NC	NC	NC	NC	NC	NC	NC	NC	NC	NC	NC	NC	NC	NC	NC	NC	NC	NC	NC	NC	NC	NC	NC	NC	NC	NC	NC	NC	NC						

AMD Athlon™ XP Processor Model 8
Topside View

Figure 16. AMD Athlon™ XP Processor Model 8 Pin Diagram – Topside View

	A	B	C	D	E	F	G	H	J	K	L	M	N	P	Q	R	S	T	U	V	W	X	Y	Z	AA	AB	AC	AD	AE	AF	AG	AH	AJ	AK	AL	AM	AN								
1			SAOP7	SAOP11	SAOP11	SAOP10	SAOP10		SAOP0		VID[0]		PICCLK		TCK		SCLOCK		TDI		FID[0]		FID[2]		DBRDDY		STPCE		AZDN#		FERR		IGNR#		IGNR				1						
2			VSS	VCC	VSS	VCC	VSS	VCC	VSS	VCC		VCC	VSS	VCC	VSS	VCC	VSS	VCC		VCC		VSS		VCC		VSS		VCC		RESE#		IMF#		FLUSH#		VCC				2					
3	SAOP12	SAOP9	SAOP9	SAOP9	SAOP9	SAOP4	SAOP4		SAOP1		VID[1]		PICDPO		TMS		SCORW		TRST#		FID[1]		FID[3]		DBREQ#		PUSIF#		PMBOK		RESE#		IMF#		FLUSH#		VSS				3				
4			VCC	VCC	VSS	VCC	VSS	VCC	VSS	VCC		VCC	VSS	VCC	VSS	VCC	VSS	VCC		VCC		VSS		VCC		VSS		VCC		VSS		VSS		VSS		VSS		VSS				4			
5	SAOP5	SAOP8	SAOP8	SAOP8	SAOP8	SAOP4	SAOP4		IC		VID[2]		PICDPI		SCORW		SCORW		TDO		VREF_5		NC		IC		VSS		VCC		IC		AMD		VCC		VCC		VSS				5		
6	SAOP3	SAOP2	SAOP2	SAOP2	SAOP6	SAOP6	SAOP6		VCC		VID[3]		KEY		KEY		THDA		THOC		VCC		KEY		KEY		KEY		VCC		KEY		KEY		KEY		KEY		VSS				6		
7			VCC	VCC	VCC	VCC	VCC		VID[4]												VCC		KEY		KEY		KEY		VCC		KEY		KEY		KEY		KEY		VCC				7		
8			VCC	VCC	VCC	VCC	VCC		IC				VCC	VSS	VCC	VSS	VCC	VSS	VCC		VCC		VSS		VSS		VSS		VCC		IC		IC		IC		IC		IC				8		
9	SOHP55	SOHP54	SOHP54	SOHP52	SOHP52		KEY																								KEY		KEY		KEY		KEY		KEY		KEY				9
10			VSS	VSS	VSS	VSS		IC																							VCC		VCC		VCC		VCC		VCC		VCC				10
11	SOHP1	SOHP3	SOHP3	SOHP3	SOHP5	SOHP5		IC																							VCC		VCC		VCC		VCC		VCC		VCC				11
12			VCC	VCC	VCC	VCC		IC																							VCC		VCC		VCC		VCC		VCC		VCC				12
13	SOHP3	IC	IC	SOHP9	SOHP9	SOHP9		IC																							VSS		VSS		VSS		VSS		VSS		VSS				13
14			VSS	VSS	VSS	VSS		IC																							VCC		VCC		VCC		VCC		VCC		VCC				14
15	SOHP3	SOHP3	SOHP3	SOHP3	SOHP3	SOHP3		KEY																							VCC		VCC		VCC		VCC		VCC		VCC				15
16			VCC	VCC	VCC	VCC		IC																							VCC		VCC		VCC		VCC		VCC		VCC				16
17	SOHP2	SOHP0	SOHP0	SOHP0	SOHP4	SOHP4		KEY																							VSS		VSS		VSS		VSS		VSS		VSS				17
18			VSS	VSS	VSS	VSS		IC																							VCC		VCC		VCC		VCC		VCC		VCC				18
19	IC	IC	SOHP9	SOHP8	SOHP8	SOHP8		IC																							VSS		VSS		VSS		VSS		VSS		VSS				19
20			VCC	VCC	VCC	VCC		IC																							VCC		VCC		VCC		VCC		VCC		VCC				20
21	SOHP7	SOHP6	SOHP6	SOHP6	SOHP6	SOHP6		IC																							VSS		VSS		VSS		VSS		VSS		VSS				21
22			VSS	VSS	VSS	VSS		IC																							VCC		VCC		VCC		VCC		VCC		VCC				22
23	SOHP9	SOHP7	SOHP7	SOHP7	SOHP4	SOHP4		KEY																							VCC		VCC		VCC		VCC		VCC		VCC				23
24			VCC	VCC	VCC	VCC		IC																							VSS		VSS		VSS		VSS		VSS		VSS				24
25	SOHP5	SOHP4	SOHP4	SOHP4	IC	IC		KEY																							VCC		VCC		VCC		VCC		VCC		VCC				25
26			VSS	VSS	VSS	VSS		IC																							VCC		VCC		VCC		VCC		VCC		VCC				26
27	SOHP4	SOHP8	SOHP8	SOHP8	SOHP2	SOHP2		IC																							VSS		VSS		VSS		VSS		VSS		VSS				27
28			VCC	VCC	VCC	VCC		IC																							VSS		VSS		VSS		VSS		VSS		VSS				28
29	SOHP4	SOHP4	SOHP4	SOHP4	SOHP3	SOHP3		IC																							VCC		VCC		VCC		VCC		VCC		VCC				29
30			VSS	VSS	VSS	VSS		IC																							VCC		VCC		VCC		VCC		VCC		VCC				30
31	IC	IC	SOHP3	SOHP2	SOHP2	SOHP2		IC																							VSS		VSS		VSS		VSS		VSS		VSS				31
32			VCC	VCC	VCC	VCC		IC																							VCC		VCC		VCC		VCC		VCC		VCC				32
33	SOHP2	SOHP2	SOHP2	SOHP2	IC	SOHP20		IC																							VSS		VSS		VSS		VSS		VSS		VSS				33
34			VSS	VSS	VSS	VSS		IC																							VCC		VCC		VCC		VCC		VCC		VCC				34
35	SOHP0	SOHP1	SOHP1	SOHP1	SOHP3	SOHP3		IC																							VSS		VSS		VSS		VSS		VSS		VSS				35
36			VCC	VCC	VCC	VCC		IC																							VSS		VSS		VSS		VSS		VSS		VSS				36
37	SOHP0	SOHP0	SOHP0	SOHP2	SOHP2	SOHP2		IC																							VCC		VCC		VCC		VCC		VCC		VCC				37

**AMD Athlon™ XP Processor
Model 8
Bottomside View**

Figure 17. AMD Athlon™ XP Processor Model 8 Pin Diagram – Bottomside View

Table 24. Pin Name Abbreviations

Abbreviation	Full Name	Pin	Abbreviation	Full Name	Pin
	A20M#	AE1		KEY	AA7
	AMD	AH6		KEY	AG7
ANLOG	ANALOG	AJ13		KEY	AG9
CLKFR	CLKFWRST	AJ21		KEY	AG15
	CLKIN	AN17		KEY	AG17
	CLKIN#	AL17		KEY	AG27
CNNCT	CONNECT	AL23		KEY	AG29
	COREFB	AG11		NC	A19
	COREFB#	AG13		NC	A31
CPR#	CPU_PRESENCE#	AK6		NC	C13
	DBRDY	AA1		NC	E25
	DBREQ#	AA3		NC	E33
	FERR	AG1		NC	F8
	FID[0]	W1		NC	F30
	FID[1]	W3		NC	G11
	FID[2]	Y1		NC	G13
	FID[3]	Y3		NC	G19
	FLUSH#	AL3		NC	G21
FSB0	FSB_Sense[0]	AG31		NC	G27
FSB1	FSB_Sense[1]	AH30		NC	G29
	IGNNE#	AJ1		NC	G31
	INIT#	AJ3		NC	H6
	INTR	AL1		NC	H8
K7CO	K7CLKOUT	AL21		NC	H10
K7CO#	K7CLKOUT#	AN21		NC	H28
	KEY	G7		NC	H30
	KEY	G9		NC	H32
	KEY	G15		NC	J5
	KEY	G17		NC	J31
	KEY	G23		NC	K8
	KEY	G25		NC	K30
	KEY	N7		NC	L31
	KEY	Q7		NC	L35
	KEY	Y7		NC	N31

Table 24. Pin Name Abbreviations (continued)

Abbreviation	Full Name	Pin	Abbreviation	Full Name	Pin
	NC	Q31		NC	AJ19
	NC	S31		NC	AJ27
	NC	U31		NC	AK8
	NC	U37		NC	AL7
	NC	W7		NC	AL9
	NC	W31		NC	AL11
	NC	Y5		NC	AL25
	NC	Y31		NC	AL27
	NC	Y33		NC	AM8
	NC	AA5		NC	AN7
	NC	AA31		NC	AN9
	NC	AC7		NC	AN11
	NC	AC31		NC	AN25
	NC	AD8		NC	AN27
	NC	AD30		NMI	AN3
	NC	AE7		PICCLK	N1
	NC	AE31	PICD#0	PICD[0]#	N3
	NC	AF6	PICD#1	PICD[1]#	N5
	NC	AF8	PLBYP#	PLLBYPASS#	AJ25
	NC	AF10	PLBYC	PLLBYPASSCLK	AN15
	NC	AF28	PLBYC#	PLLBYPASSCLK#	AL15
	NC	AF30	PLMN1	PLLMON1	AN13
	NC	AF32	PLMN2	PLLMON2	AL13
	NC	AG5	PLTST#	PLLTEST#	AC3
	NC	AG19	PRCRDY	PROCREADY	AN23
	NC	AG21		PWROK	AE3
	NC	AG23		RESET#	AG3
	NC	AG25	RCLK	RSTCLK	AN19
	NC	AH8	RCLK#	RSTCLK#	AL19
	NC	AJ7	SAI#0	SADDIN[0]#	AJ29
	NC	AJ9	SAI#1	SADDIN[1]#	AL29
	NC	AJ11	SAI#2	SADDIN[2]#	AG33
	NC	AJ15	SAI#3	SADDIN[3]#	AJ37
	NC	AJ17	SAI#4	SADDIN[4]#	AL35

Table 24. Pin Name Abbreviations (continued)

Abbreviation	Full Name	Pin	Abbreviation	Full Name	Pin
SAI#5	SADDIN[5]#	AE33	SD#3	SDATA[3]#	Y35
SAI#6	SADDIN[6]#	AJ35	SD#4	SDATA[4]#	U35
SAI#7	SADDIN[7]#	AG37	SD#5	SDATA[5]#	U33
SAI#8	SADDIN[8]#	AL33	SD#6	SDATA[6]#	S37
SAI#9	SADDIN[9]#	AN37	SD#7	SDATA[7]#	S33
SAI#10	SADDIN[10]#	AL37	SD#8	SDATA[8]#	AA33
SAI#11	SADDIN[11]#	AG35	SD#9	SDATA[9]#	AE37
SAI#12	SADDIN[12]#	AN29	SD#10	SDATA[10]#	AC33
SAI#13	SADDIN[13]#	AN35	SD#11	SDATA[11]#	AC37
SAI#14	SADDIN[14]#	AN31	SD#12	SDATA[12]#	Y37
SAIC#	SADDINCLK#	AJ33	SD#13	SDATA[13]#	AA37
SAO#0	SADDOUT[0]#	J1	SD#14	SDATA[14]#	AC35
SAO#1	SADDOUT[1]#	J3	SD#15	SDATA[15]#	S35
SAO#2	SADDOUT[2]#	C7	SD#16	SDATA[16]#	Q37
SAO#3	SADDOUT[3]#	A7	SD#17	SDATA[17]#	Q35
SAO#4	SADDOUT[4]#	E5	SD#18	SDATA[18]#	N37
SAO#5	SADDOUT[5]#	A5	SD#19	SDATA[19]#	J33
SAO#6	SADDOUT[6]#	E7	SD#20	SDATA[20]#	G33
SAO#7	SADDOUT[7]#	C1	SD#21	SDATA[21]#	G37
SAO#8	SADDOUT[8]#	C5	SD#22	SDATA[22]#	E37
SAO#9	SADDOUT[9]#	C3	SD#23	SDATA[23]#	G35
SAO#10	SADDOUT[10]#	G1	SD#24	SDATA[24]#	Q33
SAO#11	SADDOUT[11]#	E1	SD#25	SDATA[25]#	N33
SAO#12	SADDOUT[12]#	A3	SD#26	SDATA[26]#	L33
SAO#13	SADDOUT[13]#	G5	SD#27	SDATA[27]#	N35
SAO#14	SADDOUT[14]#	G3	SD#28	SDATA[28]#	L37
SAOC#	SADDOUTCLK#	E3	SD#29	SDATA[29]#	J37
SCNCK1	SCANCLK1	S1	SD#30	SDATA[30]#	A37
SCNCK2	SCANCLK2	S5	SD#31	SDATA[31]#	E35
SCNINV	SCANINTEVAL	S3	SD#32	SDATA[32]#	E31
SCNSN	SCANSHIFTEN	Q5	SD#33	SDATA[33]#	E29
SD#0	SDATA[0]#	AA35	SD#34	SDATA[34]#	A27
SD#1	SDATA[1]#	W37	SD#35	SDATA[35]#	A25
SD#2	SDATA[2]#	W35	SD#36	SDATA[36]#	E21

Table 24. Pin Name Abbreviations (continued)

Abbreviation	Full Name	Pin	Abbreviation	Full Name	Pin
SD#37	SDATA[37]#	C23	SDOC#2	SDATAOUTCLK[2]#	A33
SD#38	SDATA[38]#	C27	SDOC#3	SDATAOUTCLK[3]#	C11
SD#39	SDATA[39]#	A23	SDOV#	SDATAOUTVALID#	AL31
SD#40	SDATA[40]#	A35	SFILLV#	SFILLVALID#	AJ31
SD#41	SDATA[41]#	C35		SMI#	AN5
SD#42	SDATA[42]#	C33	STPC#	STPCLK#	AC1
SD#43	SDATA[43]#	C31		TCK	Q1
SD#44	SDATA[44]#	A29		TDI	U1
SD#45	SDATA[45]#	C29		TDO	U5
SD#46	SDATA[46]#	E23	THDA	THERMDA	S7
SD#47	SDATA[47]#	C25	THDC	THERMDC	U7
SD#48	SDATA[48]#	E17		TMS	Q3
SD#49	SDATA[49]#	E13		TRST#	U3
SD#50	SDATA[50]#	E11	VCC	V _{CC_CORE}	B4
SD#51	SDATA[51]#	C15	VCC	V _{CC_CORE}	B8
SD#52	SDATA[52]#	E9	VCC	V _{CC_CORE}	B12
SD#53	SDATA[53]#	A13	VCC	V _{CC_CORE}	B16
SD#54	SDATA[54]#	C9	VCC	V _{CC_CORE}	B20
SD#55	SDATA[55]#	A9	VCC	V _{CC_CORE}	B24
SD#56	SDATA[56]#	C21	VCC	V _{CC_CORE}	B28
SD#57	SDATA[57]#	A21	VCC	V _{CC_CORE}	B32
SD#58	SDATA[58]#	E19	VCC	V _{CC_CORE}	B36
SD#59	SDATA[59]#	C19	VCC	V _{CC_CORE}	D2
SD#60	SDATA[60]#	C17	VCC	V _{CC_CORE}	D4
SD#61	SDATA[61]#	A11	VCC	V _{CC_CORE}	D8
SD#62	SDATA[62]#	A17	VCC	V _{CC_CORE}	D12
SD#63	SDATA[63]#	A15	VCC	V _{CC_CORE}	D16
SDIC#0	SDATAINCLK[0]#	W33	VCC	V _{CC_CORE}	D20
SDIC#1	SDATAINCLK[1]#	J35	VCC	V _{CC_CORE}	D24
SDIC#2	SDATAINCLK[2]#	E27	VCC	V _{CC_CORE}	D28
SDIC#3	SDATAINCLK[3]#	E15	VCC	V _{CC_CORE}	D32
SDINV#	SDATAINVALID#	AN33	VCC	V _{CC_CORE}	F12
SDOC#0	SDATAOUTCLK[0]#	AE35	VCC	V _{CC_CORE}	F16
SDOC#1	SDATAOUTCLK[1]#	C37	VCC	V _{CC_CORE}	F20

Table 24. Pin Name Abbreviations (continued)

Abbreviation	Full Name	Pin	Abbreviation	Full Name	Pin
VCC	V _{CC_CORE}	F24	VCC	V _{CC_CORE}	X30
VCC	V _{CC_CORE}	F28	VCC	V _{CC_CORE}	X32
VCC	V _{CC_CORE}	F32	VCC	V _{CC_CORE}	X34
VCC	V _{CC_CORE}	F34	VCC	V _{CC_CORE}	X36
VCC	V _{CC_CORE}	F36	VCC	V _{CC_CORE}	Z2
VCC	V _{CC_CORE}	H2	VCC	V _{CC_CORE}	Z4
VCC	V _{CC_CORE}	H4	VCC	V _{CC_CORE}	Z6
VCC	V _{CC_CORE}	H12	VCC	V _{CC_CORE}	Z8
VCC	V _{CC_CORE}	H16	VCC	V _{CC_CORE}	AB30
VCC	V _{CC_CORE}	H20	VCC	V _{CC_CORE}	AB32
VCC	V _{CC_CORE}	H24	VCC	V _{CC_CORE}	AB34
VCC	V _{CC_CORE}	K32	VCC	V _{CC_CORE}	AB36
VCC	V _{CC_CORE}	K34	VCC	V _{CC_CORE}	AD2
VCC	V _{CC_CORE}	K36	VCC	V _{CC_CORE}	AD4
VCC	V _{CC_CORE}	M2	VCC	V _{CC_CORE}	AD6
VCC	V _{CC_CORE}	M4	VCC	V _{CC_CORE}	AF14
VCC	V _{CC_CORE}	M6	VCC	V _{CC_CORE}	AF18
VCC	V _{CC_CORE}	M8	VCC	V _{CC_CORE}	AF22
VCC	V _{CC_CORE}	P30	VCC	V _{CC_CORE}	AF26
VCC	V _{CC_CORE}	P32	VCC	V _{CC_CORE}	AF34
VCC	V _{CC_CORE}	P34	VCC	V _{CC_CORE}	AF36
VCC	V _{CC_CORE}	P36	VCC	V _{CC_CORE}	AH2
VCC	V _{CC_CORE}	R2	VCC	V _{CC_CORE}	AH4
VCC	V _{CC_CORE}	R4	VCC	V _{CC_CORE}	AH10
VCC	V _{CC_CORE}	R6	VCC	V _{CC_CORE}	AH14
VCC	V _{CC_CORE}	R8	VCC	V _{CC_CORE}	AH18
VCC	V _{CC_CORE}	T30	VCC	V _{CC_CORE}	AH22
VCC	V _{CC_CORE}	T32	VCC	V _{CC_CORE}	AH26
VCC	V _{CC_CORE}	T34	VCC	V _{CC_CORE}	AK10
VCC	V _{CC_CORE}	T36	VCC	V _{CC_CORE}	AK14
VCC	V _{CC_CORE}	V2	VCC	V _{CC_CORE}	AK18
VCC	V _{CC_CORE}	V4	VCC	V _{CC_CORE}	AK22
VCC	V _{CC_CORE}	V6	VCC	V _{CC_CORE}	AK26
VCC	V _{CC_CORE}	V8	VCC	V _{CC_CORE}	AK30

Table 24. Pin Name Abbreviations (continued)

Abbreviation	Full Name	Pin	Abbreviation	Full Name	Pin
VCC	V _{CC_CORE}	AK34	VSS		D22
VCC	V _{CC_CORE}	AK36	VSS		D26
VCC	V _{CC_CORE}	AJ5	VSS		D30
VCC	V _{CC_CORE}	AL5	VSS		D34
VCC	V _{CC_CORE}	AM2	VSS		D36
VCC	V _{CC_CORE}	AM10	VSS		F2
VCC	V _{CC_CORE}	AM14	VSS		F4
VCC	V _{CC_CORE}	AM18	VSS		F6
VCC	V _{CC_CORE}	AM22	VSS		F10
VCC	V _{CC_CORE}	AM26	VSS		F14
VCC	V _{CC_CORE}	AM22	VSS		F18
VCC	V _{CC_CORE}	AM26	VSS		F22
VCC	V _{CC_CORE}	AM30	VSS		F26
VCC	V _{CC_CORE}	AM34	VSS		H14
	VCCA	AJ23	VSS		H18
	VID[0]	L1	VSS		H22
	VID[1]	L3	VSS		H26
	VID[2]	L5	VSS		H34
	VID[3]	L7	VSS		H36
	VID[4]	J7	VSS		K2
VREF_S	VREF_SYS	W5	VSS		K4
	VSS	B2	VSS		K6
	VSS	B6	VSS		M30
	VSS	B10	VSS		M32
	VSS	B14	VSS		M34
	VSS	B18	VSS		M36
	VSS	B22	VSS		P2
	VSS	B26	VSS		P4
	VSS	B30	VSS		P6
	VSS	B34	VSS		P8
	VSS	D6	VSS		R30
	VSS	D10	VSS		R32
	VSS	D14	VSS		R34
	VSS	D18	VSS		R36

Table 24. Pin Name Abbreviations (continued)

Abbreviation	Full Name	Pin
	VSS	T2
	VSS	T4
	VSS	T6
	VSS	T8
	VSS	V30
	VSS	V32
	VSS	V34
	VSS	V36
	VSS	X2
	VSS	X4
	VSS	X6
	VSS	X8
	VSS	Z30
	VSS	Z32
	VSS	Z34
	VSS	Z36
	VSS	AB2
	VSS	AB8
	VSS	AB4
	VSS	AB6
	VSS	AD32
	VSS	AD34
	VSS	AD36
	VSS	AF2
	VSS	AF4
	VSS	AF12
	VSS	AF16
	VSS	AH12
	VSS	AH16
	VSS	AH20
	VSS	AH24
	VSS	AH28
	VSS	AH32
	VSS	AH34

Table 24. Pin Name Abbreviations (continued)

Abbreviation	Full Name	Pin
	VSS	AH36
	VSS	AK2
	VSS	AK4
	VSS	AK12
	VSS	AK16
	VSS	AK20
	VSS	AK24
	VSS	AK28
	VSS	AK32
	VSS	AM4
	VSS	AM6
	VSS	AM12
	VSS	AM16
	VSS	AM20
	VSS	AM24
	VSS	AM28
	VSS	AM32
	VSS	AM36
	ZN	AC5
	ZP	AE5

11.2 Pin List

Table 25 on page 66 cross-references Socket A pin location to signal name.

The “L” (Level) column shows the electrical specification for this pin. “P” indicates a push-pull mode driven by a single source. “O” indicates open-drain mode that allows devices to share the pin.

Note: *The AMD Athlon processor supports push-pull drivers. For more information, see “Push-Pull (PP) Drivers” on page 6.*

The “P” (Port) column indicates if this signal is an input (I), output (O), or bidirectional (B) signal. The “R” (Reference) column indicates if this signal should be referenced to VSS (G) or V_{CC_CORE} (P) planes for the purpose of signal routing with respect to the current return paths.

Table 25. Cross-Reference by Pin Location

Pin	Name	Description	L	P	R	Pin	Name	Description	L	P	R
A1	No Pin	page 78	-	-	-	B24	V _{CC_CORE}		-	-	-
A3	SADDOUT[12]#		P	O	G	B26	VSS		-	-	-
A5	SADDOUT[5]#		P	O	G	B28	V _{CC_CORE}		-	-	-
A7	SADDOUT[3]#		P	O	G	B30	VSS		-	-	-
A9	SDATA[55]#		P	B	P	B32	V _{CC_CORE}		-	-	-
A11	SDATA[61]#		P	B	P	B34	VSS		-	-	-
A13	SDATA[53]#		P	B	G	B36	V _{CC_CORE}		-	-	-
A15	SDATA[63]#		P	B	G	C1	SADDOUT[7]#		P	O	G
A17	SDATA[62]#		P	B	G	C3	SADDOUT[9]#		P	O	G
A19	NC Pin	page 78	-	-	-	C5	SADDOUT[8]#		P	O	G
A21	SDATA[57]#		P	B	G	C7	SADDOUT[2]#		P	O	G
A23	SDATA[39]#		P	B	G	C9	SDATA[54]#		P	B	P
A25	SDATA[35]#		P	B	P	C11	SDATAOUTCLK[3]#		P	O	G
A27	SDATA[34]#		P	B	P	C13	NC Pin	page 78	-	-	-
A29	SDATA[44]#		P	B	G	C15	SDATA[51]#		P	B	P
A31	NC Pin	page 78	-	-	-	C17	SDATA[60]#		P	B	G
A33	SDATAOUTCLK[2]#		P	O	P	C19	SDATA[59]#		P	B	G
A35	SDATA[40]#		P	B	G	C21	SDATA[56]#		P	B	G
A37	SDATA[30]#		P	B	P	C23	SDATA[37]#		P	B	P
B2	VSS		-	-	-	C25	SDATA[47]#		P	B	G
B4	V _{CC_CORE}		-	-	-	C27	SDATA[38]#		P	B	G
B6	VSS		-	-	-	C29	SDATA[45]#		P	B	G
B8	V _{CC_CORE}		-	-	-	C31	SDATA[43]#		P	B	G
B10	VSS		-	-	-	C33	SDATA[42]#		P	B	G
B12	V _{CC_CORE}		-	-	-	C35	SDATA[41]#		P	B	G
B14	VSS		-	-	-	C37	SDATAOUTCLK[1]#		P	O	G
B16	V _{CC_CORE}		-	-	-	D2	V _{CC_CORE}		-	-	-
B18	VSS		-	-	-	D4	V _{CC_CORE}		-	-	-
B20	V _{CC_CORE}		-	-	-	D6	VSS		-	-	-
B22	VSS		-	-	-	D8	V _{CC_CORE}		-	-	-

Table 25. Cross-Reference by Pin Location (continued)

Pin	Name	Description	L	P	R	Pin	Name	Description	L	P	R
D10	VSS		-	-	-	E33	NC Pin	page 78	-	-	-
D12	V _{CC_CORE}		-	-	-	E35	SDATA[31]#		P	B	P
D14	VSS		-	-	-	E37	SDATA[22]#		P	B	G
D16	V _{CC_CORE}		-	-	-	F2	VSS		-	-	-
D18	VSS		-	-	-	F4	VSS		-	-	-
D20	V _{CC_CORE}		-	-	-	F6	VSS		-	-	-
D22	VSS		-	-	-	F8	NC Pin	page 78	-	-	-
D24	V _{CC_CORE}		-	-	-	F10	VSS		-	-	-
D26	VSS		-	-	-	F12	V _{CC_CORE}		-	-	-
D28	V _{CC_CORE}		-	-	-	F14	VSS		-	-	-
D30	VSS		-	-	-	F16	V _{CC_CORE}		-	-	-
D32	V _{CC_CORE}		-	-	-	F18	VSS		-	-	-
D34	VSS		-	-	-	F20	V _{CC_CORE}		-	-	-
D36	VSS		-	-	-	F22	VSS		-	-	-
E1	SADDOUT[11]#		P	O	P	F24	V _{CC_CORE}		-	-	-
E3	SADDOUTCLK#		P	O	G	F26	VSS		-	-	-
E5	SADDOUT[4]#		P	O	P	F28	V _{CC_CORE}		-	-	-
E7	SADDOUT[6]#		P	O	G	F30	NC Pin	page 78	-	-	-
E9	SDATA[52]#		P	B	P	F32	V _{CC_CORE}		-	-	-
E11	SDATA[50]#		P	B	P	F34	V _{CC_CORE}		-	-	-
E13	SDATA[49]#		P	B	G	F36	V _{CC_CORE}		-	-	-
E15	SDATAINCLK[3]#		P	I	G	G1	SADDOUT[10]#		P	O	P
E17	SDATA[48]#		P	B	P	G3	SADDOUT[14]#		P	O	G
E19	SDATA[58]#		P	B	G	G5	SADDOUT[13]#		P	O	G
E21	SDATA[36]#		P	B	P	G7	Key Pin	page 78	-	-	-
E23	SDATA[46]#		P	B	P	G9	Key Pin	page 78	-	-	-
E25	NC Pin	page 78	-	-	-	G11	NC Pin	page 78	-	-	-
E27	SDATAINCLK[2]#		P	I	G	G13	NC Pin	page 78	-	-	-
E29	SDATA[33]#		P	B	P	G15	Key Pin	page 78	-	-	-
E31	SDATA[32]#		P	B	P	G17	Key Pin	page 78	-	-	-

Table 25. Cross-Reference by Pin Location (continued)

Pin	Name	Description	L	P	R	Pin	Name	Description	L	P	R
G19	NC Pin	page 78	-	-	-	J5	NC Pin	page 78	-	-	-
G21	NC Pin	page 78	-	-	-	J7	VID[4]	page 79	O	O	-
G23	Key Pin	page 78	-	-	-	J31	NC Pin	page 78	-	-	-
G25	Key Pin	page 78	-	-	-	J33	SDATA[19]#		P	B	G
G27	NC Pin	page 78	-	-	-	J35	SDATAINCLK[1]#		P	I	P
G29	NC Pin	page 78	-	-	-	J37	SDATA[29]#		P	B	P
G31	NC Pin	page 78	-	-	-	K2	VSS		-	-	-
G33	SDATA[20]#		P	B	G	K4	VSS		-	-	-
G35	SDATA[23]#		P	B	G	K6	VSS		-	-	-
G37	SDATA[21]#		P	B	G	K8	NC Pin	page 78	-	-	-
H2	V _{CC_CORE}		-	-	-	K30	NC Pin	page 78	-	-	-
H4	V _{CC_CORE}		-	-	-	K32	V _{CC_CORE}		-	-	-
H6	NC Pin	page 78	-	-	-	K34	V _{CC_CORE}		-	-	-
H8	NC Pin	page 78	-	-	-	K36	V _{CC_CORE}		-	-	-
H10	NC Pin	page 78	-	-	-	L1	VID[0]	page 79	O	O	-
H12	V _{CC_CORE}		-	-	-	L3	VID[1]	page 79	O	O	-
H14	VSS		-	-	-	L5	VID[2]	page 79	O	O	-
H16	V _{CC_CORE}		-	-	-	L7	VID[3]	page 79	O	O	-
H18	VSS		-	-	-	L31	NC Pin	page 78	-	-	-
H20	V _{CC_CORE}		-	-	-	L33	SDATA[26]#		P	B	P
H22	VSS		-	-	-	L35	NC Pin	page 78	-	-	-
H24	V _{CC_CORE}		-	-	-	L37	SDATA[28]#		P	B	P
H26	VSS		-	-	-	M2	V _{CC_CORE}		-	-	-
H28	NC Pin	page 78	-	-	-	M4	V _{CC_CORE}		-	-	-
H30	NC Pin	page 78	-	-	-	M6	V _{CC_CORE}		-	-	-
H32	NC Pin	page 78	-	-	-	M8	V _{CC_CORE}		-	-	-
H34	VSS		-	-	-	M30	VSS		-	-	-
H36	VSS		-	-	-	M32	VSS		-	-	-
J1	SADDOUT[0]#	page 79	P	O	-	M34	VSS		-	-	-
J3	SADDOUT[1]#	page 79	P	O	-	M36	VSS		-	-	-

Table 25. Cross-Reference by Pin Location (continued)

Pin	Name	Description	L	P	R	Pin	Name	Description	L	P	R
N1	PICCLK	page 74	O	I	-	R34	VSS		-	-	-
N3	PICD#[0]	page 74	O	B	-	R36	VSS		-	-	-
N5	PICD#[1]	page 74	O	B	-	S1	SCANCLK1	page 79	P	I	-
N7	Key Pin	page 78	-	-	-	S3	SCANINTEVAL	page 79	P	I	-
N31	NC Pin	page 78	-	-	-	S5	SCANCLK2	page 79	P	I	-
N33	SDATA[25]#		P	B	P	S7	THERMDA	page 79	-	-	-
N35	SDATA[27]#		P	B	P	S31	NC Pin	page 78	-	-	-
N37	SDATA[18]#		P	B	G	S33	SDATA[7]#		P	B	G
P2	VSS		-	-	-	S35	SDATA[15]#		P	B	P
P4	VSS		-	-	-	S37	SDATA[6]#		P	B	G
P6	VSS		-	-	-	T2	VSS		-	-	-
P8	VSS		-	-	-	T4	VSS		-	-	-
P30	V _{CC_CORE}		-	-	-	T6	VSS		-	-	-
P32	V _{CC_CORE}		-	-	-	T8	VSS		-	-	-
P34	V _{CC_CORE}		-	-	-	T30	V _{CC_CORE}		-	-	-
P36	V _{CC_CORE}		-	-	-	T32	V _{CC_CORE}		-	-	-
Q1	TCK	page 77	P	I	-	T34	V _{CC_CORE}		-	-	-
Q3	TMS	page 77	P	I	-	T36	V _{CC_CORE}		-	-	-
Q5	SCANSHIFTEN	page 79	P	I	-	U1	TDI	page 77	P	I	-
Q7	Key Pin	page 78	-	-	-	U3	TRST#	page 77	P	I	-
Q31	NC Pin	page 78	-	-	-	U5	TDO	page 77	P	O	-
Q33	SDATA[24]#		P	B	P	U7	THERMDC	page 79	-	-	-
Q35	SDATA[17]#		P	B	G	U31	NC Pin	page 78	-	-	-
Q37	SDATA[16]#		P	B	G	U33	SDATA[5]#		P	B	G
R2	V _{CC_CORE}		-	-	-	U35	SDATA[4]#		P	B	G
R4	V _{CC_CORE}		-	-	-	U37	NC Pin	page 78	-	-	-
R6	V _{CC_CORE}		-	-	-	V2	V _{CC_CORE}		-	-	-
R8	V _{CC_CORE}		-	-	-	V4	V _{CC_CORE}		-	-	-
R30	VSS		-	-	-	V6	V _{CC_CORE}		-	-	-
R32	VSS		-	-	-	V8	V _{CC_CORE}		-	-	-

Table 25. Cross-Reference by Pin Location (continued)

Pin	Name	Description	L	P	R	Pin	Name	Description	L	P	R
V30	VSS		-	-	-	Z6	V _{CC_CORE}		-	-	-
V32	VSS		-	-	-	Z8	V _{CC_CORE}		-	-	-
V34	VSS		-	-	-	Z30	VSS		-	-	-
V36	VSS		-	-	-	Z32	VSS		-	-	-
W1	FID[0]	page 76	O	O	-	Z34	VSS		-	-	-
W3	FID[1]	page 76	O	O	-	Z36	VSS		-	-	-
W5	VREFSYS	page 80	P	-	-	AA1	DBRDY	page 75	P	O	-
W7	NC Pin	page 78	-	-	-	AA3	DBREQ#	page 75	P	I	-
W31	NC Pin	page 78	-	-	-	AA5	NC		-	-	-
W33	SDATAINCLK[0]#		P	I	G	AA7	Key Pin	page 78	-	-	-
W35	SDATA[2]#		P	B	G	AA31	NC Pin	page 78	-	-	-
W37	SDATA[1]#		P	B	P	AA33	SDATA[8]#		P	B	P
X2	VSS		-	-	-	AA35	SDATA[0]#		P	B	G
X4	VSS		-	-	-	AA37	SDATA[13]#		P	B	G
X6	VSS		-	-	-	AB2	VSS		-	-	-
X8	VSS		-	-	-	AB4	VSS		-	-	-
X30	V _{CC_CORE}		-	-	-	AB6	VSS		-	-	-
X32	V _{CC_CORE}		-	-	-	AB8	VSS		-	-	-
X34	V _{CC_CORE}		-	-	-	AB30	V _{CC_CORE}		-	-	-
X36	V _{CC_CORE}		-	-	-	AB32	V _{CC_CORE}		-	-	-
Y1	FID[2]	page 76	O	O	-	AB34	V _{CC_CORE}		-	-	-
Y3	FID[3]	page 76	O	O	-	AB36	V _{CC_CORE}		-	-	-
Y5	NC Pin	page 78	-	-	-	AC1	STPCLK#	page 79	P	I	-
Y7	Key Pin	page 78	-	-	-	AC3	PLLTEST#	page 78	P	I	-
Y31	NC Pin	page 78	-	-	-	AC5	ZN	page 80	P	-	-
Y33	NC Pin	page 78	-	-	-	AC7	NC		-	-	-
Y35	SDATA[3]#		P	B	G	AC31	NC Pin	page 78	-	-	-
Y37	SDATA[12]#		P	B	P	AC33	SDATA[10]#		P	B	P
Z2	V _{CC_CORE}		-	-	-	AC35	SDATA[14]#		P	B	G
Z4	V _{CC_CORE}		-	-	-	AC37	SDATA[11]#		P	B	G

Table 25. Cross-Reference by Pin Location (continued)

Pin	Name	Description	L	P	R	Pin	Name	Description	L	P	R
AD2	V _{CC_CORE}		-	-	-	AF30	NC Pin	page 78	-	-	-
AD4	V _{CC_CORE}		-	-	-	AF32	NC Pin	page 78	-	-	-
AD6	V _{CC_CORE}		-	-	-	AF34	V _{CC_CORE}		-	-	-
AD8	NC Pin	page 78	-	-	-	AF36	V _{CC_CORE}		-	-	-
AD30	NC Pin	page 78	-	-	-	AG1	FERR	page 75	P	O	-
AD32	VSS		-	-	-	AG3	RESET#		-	I	-
AD34	VSS		-	-	-	AG5	NC Pin	page 78	-	-	-
AD36	VSS		-	-	-	AG7	Key Pin	page 78	-	-	-
AE1	A20M#		P	I	-	AG9	Key Pin	page 78	-	-	-
AE3	PWROK		P	I	-	AG11	COREFB	page 75	-	-	-
AE5	ZP	page 80	P	-	-	AG13	COREFB#	page 75	-	-	-
AE7	NC		-	-	-	AG15	Key Pin	page 78	-	-	-
AE31	NC Pin	page 78	-	-	-	AG17	Key Pin	page 78	-	-	-
AE33	SADDIN[5]#		P	I	G	AG19	NC Pin	page 78	-	-	-
AE35	SDATAOUTCLK[0]#		P	O	P	AG21	NC Pin	page 78	-	-	-
AE37	SDATA[9]#		P	B	G	AG23	NC Pin	page 78	-	-	-
AF2	VSS		-	-	-	AG25	NC Pin	page 78	-	-	-
AF4	VSS		-	-	-	AG27	Key Pin	page 78	-	-	-
AF6	NC Pin	page 78	-	-	-	AG29	Key Pin	page 78	-	-	-
AF8	NC Pin	page 78	-	-	-	AG31	FSB_Sense[0]	page 77	-	O	G
AF10	NC Pin	page 78	-	-	-	AG33	SADDIN[2]#		P	I	G
AF12	VSS		-	-	-	AG35	SADDIN[11]#		P	I	G
AF14	V _{CC_CORE}		-	-	-	AG37	SADDIN[7]#		P	I	P
AF16	VSS		-	-	-	AH2	V _{CC_CORE}		-	-	-
AF18	V _{CC_CORE}		-	-	-	AH4	V _{CC_CORE}		-	-	-
AF20	VSS		-	-	-	AH6	AMD Pin	page 74	-	-	-
AF22	V _{CC_CORE}		-	-	-	AH8	NC Pin	page 78	-	-	-
AF24	VSS		-	-	-	AH10	V _{CC_CORE}		-	-	-
AF26	V _{CC_CORE}		-	-	-	AH12	VSS		-	-	-
AF28	NC Pin	page 78	-	-	-	AH14	V _{CC_CORE}		-	-	-

Table 25. Cross-Reference by Pin Location (continued)

Pin	Name	Description	L	P	R	Pin	Name	Description	L	P	R
AH16	VSS		-	-	-	AK2	VSS		-	-	-
AH18	V _{CC_CORE}		-	-	-	AK4	VSS		-	-	-
AH20	VSS		-	-	-	AK6	CPU_PRESENCE#	page 75	-	-	-
AH22	V _{CC_CORE}		-	-	-	AK8	NC Pin	page 78	-	-	-
AH24	VSS		-	-	-	AK10	V _{CC_CORE}		-	-	-
AH26	V _{CC_CORE}		-	-	-	AK12	VSS		-	-	-
AH28	VSS		-	-	-	AK14	V _{CC_CORE}		-	-	-
AH30	FSB_Sense[1]	page 77	-	O	G	AK16	VSS		-	-	-
AH32	VSS		-	-	-	AK18	V _{CC_CORE}		-	-	-
AH34	VSS		-	-	-	AK20	VSS		-	-	-
AH36	VSS		-	-	-	AK22	V _{CC_CORE}		-	-	-
AJ1	IGNNE#	page 77	P	I	-	AK24	VSS		-	-	-
AJ3	INIT#	page 77	P	I	-	AK26	V _{CC_CORE}		-	-	-
AJ5	V _{CC_CORE}		-	-	-	AK28	VSS		-	-	-
AJ7	NC Pin	page 78	-	-	-	AK30	V _{CC_CORE}		-	-	-
AJ9	NC Pin	page 78	-	-	-	AK32	VSS		-	-	-
AJ11	NC Pin	page 78	-	-	-	AK34	V _{CC_CORE}		-	-	-
AJ13	Analog	page 74	-	-	-	AK36	V _{CC_CORE}		-	-	-
AJ15	NC Pin	page 78	-	-	-	AL1	INTR	page 77	P	I	-
AJ17	NC Pin	page 78	-	-	-	AL3	FLUSH#	page 77	P	I	-
AJ19	NC Pin	page 78	-	-	-	AL5	V _{CC_CORE}		-	-	-
AJ21	CLKFWRST	page 74	P	I	P	AL7	NC Pin	page 78	-	-	-
AJ23	VCCA	page 79	-	-	-	AL9	NC Pin	page 78	-	-	-
AJ25	PLLBYPASS#	page 78	P	I	-	AL11	NC Pin	page 78	-	-	-
AJ27	NC Pin	page 78	-	-	-	AL13	PLLMON2	page 78	O	O	-
AJ29	SADDIN[0]#	page 79	P	I	-	AL15	PLLBYPASSCLK#	page 78	P	I	-
AJ31	SFILLVALID#		P	I	G	AL17	CLKIN#	page 74	P	I	P
AJ33	SADDINCLK#		P	I	G	AL19	RSTCLK#	page 74	P	I	P
AJ35	SADDIN[6]#		P	I	P	AL21	K7CLKOUT	page 78	P	O	-
AJ37	SADDIN[3]#		P	I	G	AL23	CONNECT	page 75	P	I	P

Table 25. Cross-Reference by Pin Location

Pin	Name	Description	L	P	R
AL25	NC Pin	page 78	-	-	-
AL27	NC Pin	page 78	-	-	-
AL29	SADDIN[1]#	page 79	P	I	-
AL31	SDATAOUTVALID#		P	O	P
AL33	SADDIN[8]#		P	I	P
AL35	SADDIN[4]#		P	I	G
AL37	SADDIN[10]#		P	I	G
AM2	V _{CC_CORE}		-	-	-
AM4	VSS		-	-	-
AM6	VSS		-	-	-
AM8	NC Pin	page 78	-	-	-
AM10	V _{CC_CORE}		-	-	-
AM12	VSS		-	-	-
AM14	V _{CC_CORE}		-	-	-
AM16	VSS		-	-	-
AM18	V _{CC_CORE}		-	-	-
AM20	VSS		-	-	-
AM22	V _{CC_CORE}		-	-	-
AM24	VSS		-	-	-
AM26	V _{CC_CORE}		-	-	-
AM28	VSS		-	-	-
AM30	V _{CC_CORE}		-	-	-
AM32	VSS		-	-	-
AM34	V _{CC_CORE}		-	-	-
AM36	VSS		-	-	-
AN1	No Pin	page 78	-	-	-
AN3	NMI		P	I	-
AN5	SMI#		P	I	-
AN7	NC Pin	page 78	-	-	-
AN9	NC Pin	page 78	-	-	-

Table 25. Cross-Reference by Pin Location

Pin	Name	Description	L	P	R
AN11	NC Pin	page 78	-	-	-
AN13	PLLMON1	page 78	O	B	-
AN15	PLLBYPASSCLK	page 78	P	I	-
AN17	CLKIN	page 74	P	I	P
AN19	RSTCLK	page 74	P	I	P
AN21	K7CLKOUT#	page 78	P	O	-
AN23	PROCRDY		P	O	P
AN25	NC Pin	page 78	-	-	-
AN27	NC Pin	page 78	-	-	-
AN29	SADDIN[12]#		P	I	G
AN31	SADDIN[14]#		P	I	G
AN33	SDATAINVALID#		P	I	P
AN35	SADDIN[13]#		P	I	G
AN37	SADDIN[9]#		P	I	G

11.3 Detailed Pin Descriptions

The information in this section pertains to Table 25 on page 66.

A20M# Pin

A20M# is an input from the system used to simulate address wrap-around in the 20-bit 8086.

AMD Pin

AMD Socket A processors do not implement a pin at location AH6. All Socket A designs must have a top plate or cover that blocks this pin location. When the cover plate blocks this location, a non-AMD part (e.g., PGA370) does not fit into the socket. However, socket manufacturers are allowed to have a contact loaded in the AH6 position. Therefore, motherboard socket design should account for the possibility that a contact could be loaded in this position.

AMD Athlon™ System Bus Pins

See the *AMD Athlon™ System Bus Specification*, order# 21902 for information about the system bus pins—PROCRDY, PWROK, RESET#, SADDIN[14:2]#, SADDINCLK#, SADDOUT[14:2]#, SADDOUTCLK#, SDATA[63:0]#, SDATAINCLK[3:0]#, SDATAINVALID#, SDATAOUTCLK[3:0]#, SDATAOUTVALID#, SFILLINVALID#.

Analog Pin

Treat this pin as a NC.

APIC Pins, PICCLK, PICD[1:0]#

The Advanced Programmable Interrupt Controller (APIC) is a feature that provides a flexible and expandable means of delivering interrupts in a system using an AMD processor. The pins, PICD[1:0], are the bi-directional message-passing signals used for the APIC and are driven to the Southbridge or a dedicated I/O APIC. The pin, PICCLK, must be driven with a valid clock input.

For more information, see Table 19, “APIC Pin AC and DC Characteristics,” on page 44.

CLKFWRST Pin

CLKFWRST resets clock-forward circuitry for both the system and processor.

CLKIN, RSTCLK (SYSCLK) Pins

Connect CLKIN with RSTCLK and name it SYSCLK. Connect CLKIN# with RSTCLK# and name it SYSCLK#. Length match the clocks from the clock generator to the Northbridge and processor.

See “SYSCLK and SYSCLK#” on page 79 for more information.

CONNECT Pin	CONNECT is an input from the system used for power management and clock-forward initialization at reset.
COREFB and COREFB# Pins	COREFB and COREFB# are outputs to the system that provide processor core voltage feedback to the system.
CPU_PRESENCE# Pin	CPU_PRESENCE# is connected to VSS on the processor package. If pulled-up on the motherboard, CPU_PRESENCE# may be used to detect the presence or absence of a processor in the Socket A-style socket.
DBRDY and DBREQ# Pins	DBRDY and DBREQ# are routed to the debug connector. DBREQ# is tied to V _{CC_CORE} with a pullup resistor.
FERR Pin	FERR is an output to the system that is asserted for any unmasked numerical exception independent of the NE bit in CR0. FERR is a push-pull active High signal that must be inverted and level shifted to an active Low signal. For more information about FERR and FERR#, see the “Required Circuits” chapter of the <i>AMD Athlon™ Processor-Based Motherboard Design Guide</i> , order# 24363.
FID[3:0] Pins	FID[3] (Y3), FID[2] (Y1), FID[1] (W3), and FID[0] (W1) are the 4-bit processor clock-to-SYSCLK ratio. Table 26 on page 76 shows the encodings of the clock multipliers on FID[3:0].

Table 26. FID[3:0] Clock Multiplier Encodings

FID[3:0] ²	Processor Clock to SYSCLK Frequency Ratio
0000	11
0001	11.5
0010	12
0011	≥ 12.5 ¹
0100	5
0101	5.5
0110	6
0111	6.5
1000	7
1001	7.5
1010	8
1011	8.5
1100	9
1101	9.5
1110	10
1111	10.5

Notes:

1. All ratios greater than or equal to 12.5x have the same FID[3:0] code of 0011b, which causes the SIP configuration for all ratios of 12.5x or greater to be the same.
2. BIOS initializes the CLK_Ctl MSR during the POST routine. This CLK_Ctl setting is used with all FID combinations and selects a Halt disconnect divisor and a Stop Grant disconnect divisor. For more information, refer to the AMD Athlon™ and AMD Duron™ Processors BIOS, Software, and Debug Developers Guide, order# 21656.

The FID[3:0] signals are open-drain processor outputs that are pulled High on the motherboard and sampled by the chipset to determine the SIP (Serialization Initialization Packet) that is sent to the processor. The FID[3:0] signals are valid after PWROK is asserted. The FID[3:0] signals must not be sampled until they become valid. See the *AMD Athlon™ System Bus Specification*, order# 21902 for more information about Serialization Initialization Packets and SIP protocol.

The processor FID[3:0] outputs are open-drain and 2.5-V tolerant. To prevent damage to the processor, if these signals are pulled High to above 2.5 V, they must be electrically isolated from the processor. For information about the FID[3:0] isolation circuit, see the *AMD Athlon™ Processor-Based Motherboard Design Guide*, order# 24363.

See “Frequency Identification (FID[3:0])” on page 33 for the DC characteristics for FID[3:0].

FSB_Sense[1:0] Pins

FSB_Sense[1:0] pins are either open circuit (logic level of 1) or are pulled to ground (logic level of 0) on the processor package with a 1 kΩ resistor. In conjunction with a circuit on the motherboard, these pins may be used to automatically detect the front-side bus (FSB) setting of this processor. Proper detection of the FSB setting requires the implementation of a pull-up resistor on the motherboard. Refer to the *AMD Athlon™ Processor-Based Motherboard Design Guide*, order# 24363 and the technical note *FSB_Sense Auto Detection Circuitry for Desktop Processors*, order# TN26673 for more information.

Table 27 is the truth table to determine the FSB of desktop processors.

Table 27. Front-Side Bus Sense Truth Table

FSB_Sense[1]	FSB_Sense[0]	Bus Frequency
1	0	RESERVED
1	1	133 MHz
0	1	166 MHz
0	0	RESERVED

The FSB_Sense[1:0] pins are 3.3-V tolerant.

FLUSH# Pin

FLUSH# must be tied to V_{CC_CORE} with a pullup resistor. If a debug connector is implemented, FLUSH# is routed to the debug connector.

IGNNE# Pin

IGNNE# is an input from the system that tells the processor to ignore numeric errors.

INIT# Pin

INIT# is an input from the system that resets the integer registers without affecting the floating-point registers or the internal caches. Execution starts at 0_FFFF_FFF0h.

INTR Pin

INTR is an input from the system that causes the processor to start an interrupt acknowledge transaction that fetches the 8-bit interrupt vector and starts execution at that location.

JTAG Pins

TCK, TMS, TDI, TRST#, and TDO are the JTAG interface. Connect these pins directly to the motherboard debug connector. Pull TDI, TCK, TMS, and TRST# up to V_{CC_CORE} with pullup resistors.

K7CLKOUT and K7CLKOUT# Pins

K7CLKOUT and K7CLKOUT# are each run for two to three inches and then terminated with a resistor pair: 100 ohms to V_{CC_CORE} and 100 ohms to VSS. The effective termination resistance and voltage are 50 ohms and $V_{CC_CORE}/2$.

Key Pins

These 16 locations are for processor type keying for forwards and backwards compatibility (G7, G9, G15, G17, G23, G25, N7, Q7, Y7, AA7, AG7, AG9, AG15, AG17, AG27, and AG29). Motherboard designers should treat key pins like NC (No Connect) pins. A socket designer has the option of creating a top mold piece that allows PGA key pins only where designated. However, sockets that populate all 16 key pins must be allowed, so the motherboard must always provide for pins at all key pin locations.

See “NC Pins” for more information.

NC Pins

The motherboard should provide a plated hole for an NC pin. The pin hole should not be electrically connected to anything.

NMI Pin

NMI is an input from the system that causes a non-maskable interrupt.

DataSheet4U.com

PGA Orientation Pins

No pin is present at pin locations A1 and AN1. Motherboard designers should not allow for a PGA socket pin at these locations.

For more information, see the *AMD Athlon™ Processor-Based Motherboard Design Guide*, order# 24363.

PLL Bypass and Test Pins

PLLTEST#, PLLBYPASS#, PLLMON1, PLLMON2, PLLBYPASSCLK, and PLLBYPASSCLK# are the PLL bypass and test interface. This interface is tied disabled on the motherboard. All six pin signals are routed to the debug connector. All four processor inputs (PLLTEST#, PLLBYPASS#, PLLMON1, and PLLMON2) are tied to V_{CC_CORE} with pullup resistors.

PWROK Pin

The PWROK input to the processor must not be asserted until all voltage planes in the system are within specification and all system clocks are running within specification.

For more information, Chapter 9, “Signal and Power-Up Requirements” on page 45.

SADDIN[1:0]# and SADDOUT[1:0]# Pins

The AMD Athlon XP processor model 8 does not support SADDIN[1:0]# or SADDOUT[1:0]#. SADDIN[1]# is tied to VCC with pullup resistors, if this bit is not supported by the Northbridge (future models can support SADDIN[1]#). SADDOUT[1:0]# are tied to VCC with pullup resistors if these pins are supported by the Northbridge. For more information, see the *AMD Athlon™ System Bus Specification*, order# 21902.

Scan Pins

SCANSHIFTEN, SCANCLK1, SCANINTEVAL, and SCANCLK2 are the scan interface. This interface is AMD internal and is tied disabled with pulldown resistors to ground on the motherboard.

SMI# Pin

SMI# is an input that causes the processor to enter the system management mode.

STPCLK# Pin

STPCLK# is an input that causes the processor to enter a lower power mode and issue a Stop Grant special cycle.

SYSCLK and SYSCLK#

SYSCLK and SYSCLK# are differential input clock signals provided to the PLL of the processor from a system-clock generator.

See “CLKIN, RSTCLK (SYSCLK) Pins” on page 74 for more information. [DataSheet4U.com](http://www.DataSheet4U.com)

THERMDA and THERMDC Pins

Thermal Diode anode and cathode pins are used to monitor the actual temperature of the processor die, providing more accurate temperature control to the system.

See Table 17, “Thermal Diode Electrical Characteristics,” on page 42 for more information.

VCCA Pin

VCCA is the processor PLL supply. For information about the VCCA pin, see Table 5, “VCCA AC and DC Characteristics,” on page 35 and the *AMD Athlon™ Processor-Based Motherboard Design Guide*, order# 24363.

VID[4:0] Pins

The VID[4:0] (Voltage Identification) outputs are used to dictate the V_{CC_CORE} voltage level. The VID[4:0] pins are strapped to ground or left unconnected on the processor package. The VID[4:0] pins are pulled-up on the motherboard and used by the V_{CC_CORE} DC/DC converter.

The VID codes and corresponding voltage levels are shown in Table 28.

Table 28. VID[4:0] Code to Voltage Definition

VID[4:0]	V _{CC_CORE} (V)	VID[4:0]	V _{CC_CORE} (V)
00000	1.850	10000	1.450
00001	1.825	10001	1.425
00010	1.800	10010	1.400
00011	1.775	10011	1.375
00100	1.750	10100	1.350
00101	1.725	10101	1.325
00111	1.675	10111	1.275
01000	1.650	11000	1.250
01001	1.625	11001	1.225
01010	1.600	11010	1.200
01011	1.575	11011	1.175
01100	1.550	11100	1.150
01101	1.525	11101	1.125
01110	1.500	11110	1.100
01111	1.475	11111	No CPU

For more information, see the “Required Circuits” chapter of the *AMD Athlon™ Processor-Based Motherboard Design Guide*, order# 24363.

VREFSYS Pin

VREFSYS (W5) drives the threshold voltage for the system bus input receivers. The value of VREFSYS is system specific. In addition, to minimize V_{CC_CORE} noise rejection from VREFSYS, include decoupling capacitors. For more information, see the *AMD Athlon™ Processor-Based Motherboard Design Guide*, order# 24363.

ZN and ZP Pins

ZN (AC5) and ZP (AE5) are the push-pull compensation circuit pins. In Push-Pull mode (selected by the SIP parameter SysPushPull asserted), ZN is tied to V_{CC_CORE} with a resistor that has a resistance matching the impedance Z₀ of the transmission line. ZP is tied to VSS with a resistor that has a resistance matching the impedance Z₀ of the transmission line.

12 Ordering Information

This section provides the ordering information for the AMD Athlon™ XP processor model 8.

Standard AMD Athlon™ XP Processor Model 8 Products

AMD standard products are available in several operating ranges. The ordering part numbers (OPN) are formed by a combination of the elements, as shown in Figure 18.

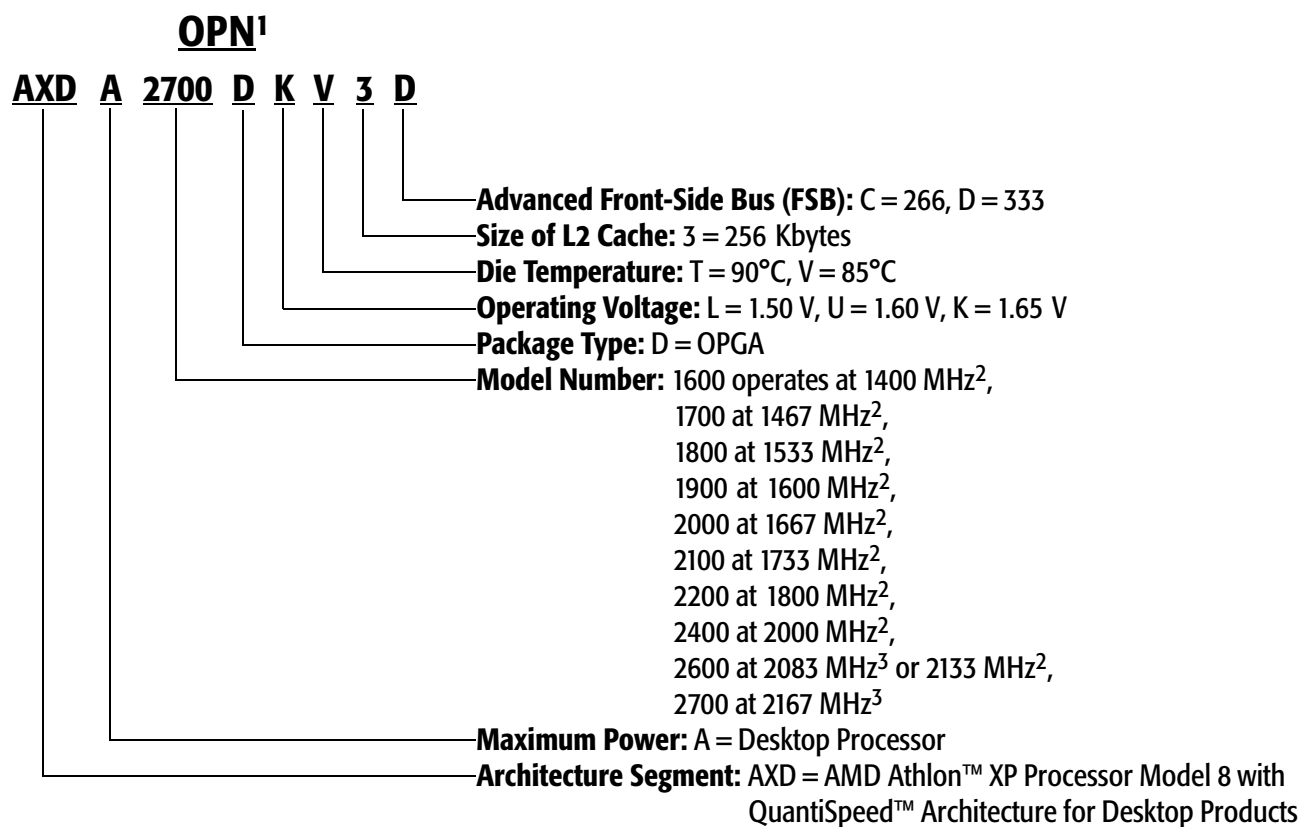

Notes:

1. Spaces are added to the number shown above for viewing clarity only.
2. This processor is available only with a 266 advanced FSB.
3. This processor is available only with a 333 advanced FSB.

Figure 18. OPN Example for the AMD Athlon™ XP Processor Model 8



et4U.com

DataShee

DataSheet4U.com

Appendix A

Thermal Diode Calculations

This section contains information about the calculations for the on-die thermal diode of the AMD Athlon™ XP processor model 8. For electrical information about this thermal diode, see Table 17, “Thermal Diode Electrical Characteristics,” on page 42.

Ideal Diode Equation

The ideal diode equation uses the variables and constants defined in Table 29.

Table 29. Constants and Variables for the Ideal Diode Equation

Equation Symbol	Variable, Constant Description
η_f , lumped	Lumped ideality factor
k	Boltzmann constant
q	Electron charge constant
T	Diode temperature (Kelvin)
V_{BE}	Voltage from base to emitter
I_C	Collector current
I_S	Saturation current

Equation (1) shows the ideal diode calculation.

$$V_{BE} = n_{f,lumped} \cdot \frac{k}{q} \cdot T \cdot \ln\left(\frac{I_C}{I_S}\right) \quad (1)$$

Sourcing two currents and using Equation (1) derives the difference in the base-to-emitter voltage that leads to finding the diode temperature as shown in Equation (2). The use of dual sourcing currents allows the measurement of the thermal diode temperature to be more accurate and less susceptible to die and process revisions. Temperature sensors that utilize series resistance cancellation can use more than two sourcing currents and are suitable to be used with the AMD thermal diode. Equation (2) is the formula for calculating the temperature of a thermal diode.

$$T = \frac{V_{BE,high} - V_{BE,low}}{n_{f,lumped} \cdot \frac{k}{q} \cdot \ln\left(\frac{I_{high}}{I_{low}}\right)} \quad (2)$$

Temperature Offset Correction

A temperature offset may be required to correct the value measured by a temperature sensor. An offset is necessary if a difference exists between the lumped ideality factor of the processor and the ideality factor assumed by the temperature sensor. The lumped ideality factor can be calculated using the equations in this section to find the temperature offset that should be used with the temperature sensor.

Table 30 shows the constants and variables used to calculate the temperature offset correction.

Table 30. Constants and Variables Used in Temperature Offset Equations

Equation Symbol	Variable, Constant Description
$n_{f, actual}$	Actual ideality factor
$n_{f, lumped}$	Lumped ideality factor
$n_{f, TS}$	Ideality factor assumed by temperature sensor
I_{high}	High sourcing current
I_{low}	Low sourcing current
$T_{die, spec}$	Die temperature specification
T_{offset}	Temperature offset

The formulas in Equation (3) and Equation (4) can be used to calculate the temperature offset for temperature sensors that do not employ series resistance cancellation. The result is added to the value measured by the temperature sensor. Contact the vendor of the temperature sensor being used for the value of $n_{f,TS}$. Refer to the document, *On-Die Thermal Diode Characterization*, order# 25443, for further details.

Equation (3) shows the equation for calculating the lumped ideality factor ($n_{f,lumped}$) in sensors that do not employ series resistance cancellation.

$$n_{f,lumped} = n_{f,actual} + \frac{R_T \cdot (I_{high} - I_{low})}{\frac{k}{q}(T_{die,spec} + 273.15) \cdot \ln\left(\frac{I_{high}}{I_{low}}\right)} \quad (3)$$

Equation (4) shows the equation for calculating temperature offset (T_{offset}) in sensors that do not employ series resistance cancellation.

$$T_{offset} = (T_{die,spec} + 273.15) \cdot \left(1 - \frac{n_{f,lumped}}{n_{f,TS}}\right) \quad (4)$$

Equation (5) is the temperature offset for temperature sensors that utilize series resistance cancellation. Add the result to the value measured by the temperature sensor. Note that the value of $n_{f,TS}$ in Equation (5) may not equal the value used in Equation (4).

$$T_{offset} = (T_{die,spec} + 273.15) \cdot \left(1 - \frac{n_{f,actual}}{n_{f,TS}}\right) \quad (5)$$



et4U.com

DataShee

DataSheet4U.com

Appendix B

Conventions and Abbreviations

This section contains information about the conventions and abbreviations used in this document.

Signals and Bits

DataSheet4U.com

- **Active-Low Signals**—Signal names containing a pound sign, such as SFILL#, indicate active-Low signals. They are asserted in their Low-voltage state and negated in their High-voltage state. When used in this context, High and Low are written with an initial upper case letter.
- **Signal Ranges**—In a range of signals, the highest and lowest signal numbers are contained in brackets and separated by a colon (for example, D[63:0]).
- **Reserved Bits and Signals**—Signals or bus bits marked *reserved* must be driven inactive or left unconnected, as indicated in the signal descriptions. These bits and signals are reserved by AMD for future implementations. When software reads registers with reserved bits, the reserved bits must be masked. When software writes such registers, it must first read the register and change only the non-reserved bits before writing back to the register.
- **Three-State**—In timing diagrams, signal ranges that are high impedance are shown as a straight horizontal line half-way between the high and low levels.

- Invalid and Don't-Care—In timing diagrams, signal ranges that are invalid or don't-care are filled with a screen pattern.

Data Terminology

The following list defines data terminology:

- Quantities
 - A *word* is two bytes (16 bits)
 - A *doubleword* is four bytes (32 bits)
 - A *quadword* is eight bytes (64 bits)
- Addressing—Memory is addressed as a series of bytes on eight-byte (64-bit) boundaries in which each byte can be separately enabled.
- Abbreviations—The following notation is used for bits and bytes:
 - Kilo (K, as in 4-Kbyte page)
 - Mega (M, as in 4 Mbits/sec)
 - Giga (G, as in 4 Gbytes of memory space)
 See Table 31 on page 89 for more abbreviations.
- Little-Endian Convention—The byte with the address *xx...xx00* is in the least-significant byte position (little end). In byte diagrams, bit positions are numbered from right to left—the little end is on the right and the big end is on the left. Data structure diagrams in memory show low addresses at the bottom and high addresses at the top. When data items are aligned, bit notation on a 64-bit data bus maps directly to bit notation in 64-bit-wide memory. Because byte addresses increase from right to left, strings appear in reverse order when illustrated.
- Bit Ranges—In text, bit ranges are shown with a dash (for example, bits 9–1). When accompanied by a signal or bus name, the highest and lowest bit numbers are contained in brackets and separated by a colon (for example, AD[31:0]).
- Bit Values—Bits can either be set to 1 or cleared to 0.
- Hexadecimal and Binary Numbers—Unless the context makes interpretation clear, hexadecimal numbers are followed by an h and binary numbers are followed by a b.

Abbreviations and Acronyms

Table 31 contains the definitions of abbreviations used in this document.

Table 31. Abbreviations

Abbreviation	Meaning
A	Ampere
F	Farad
G	Giga-
Gbit	Gigabit
Gbyte	Gigabyte
GHz	Gigahertz
H	Henry
h	Hexadecimal
K	Kilo-
Kbyte	Kilobyte
lbf	Foot-pound
M	Mega-
Mbit	Megabit
Mbyte	Megabyte
MHz	Megahertz
m	Milli-
ms	Millisecond
mW	Milliwatt
μ	Micro-
μA	Microampere
μF	Microfarad
μH	Microhenry
μs	Microsecond
μV	Microvolt
n	nano-
nA	nanoampere
nF	nanofarad
nH	nanohenry
ns	nanosecond
ohm	Ohm

Table 31. Abbreviations (continued)

Abbreviation	Meaning
p	pico-
pA	picoampere
pF	picofarad
pH	picohenry
ps	picosecond
s	Second
V	Volt
W	Watt

Table 32 contains the definitions of acronyms used in this document.

Table 32. Acronyms

Abbreviation	Meaning
ACPI	Advanced Configuration and Power Interface
AGP	Accelerated Graphics Port
APCI	AGP Peripheral Component Interconnect
API	Application Programming Interface
APIC	Advanced Programmable Interrupt Controller
BIOS	Basic Input/Output System
BIST	Built-In Self-Test
BIU	Bus Interface Unit
CPGA	Ceramic Pin Grid Array
DDR	Double-Data Rate
DIMM	Dual Inline Memory Module
DMA	Direct Memory Access
DRAM	Direct Random Access Memory
DSP	Digital Signal Processing
EIDE	Enhanced Integrated Device Electronics
EISA	Extended Industry Standard Architecture
EPROM	Enhanced Programmable Read Only Memory
FIFO	First In, First Out
GART	Graphics Address Remapping Table
HSTL	High-Speed Transistor Logic

Table 32. Acronyms (continued)

Abbreviation	Meaning
IDE	Integrated Device Electronics
ISA	Industry Standard Architecture
IPC	Instructions Per Cycle
JEDEC	Joint Electron Device Engineering Council
JTAG	Joint Test Action Group
LAN	Large Area Network
LRU	Least-Recently Used
LVTTTL	Low Voltage Transistor Transistor Logic
MSB	Most Significant Bit
MTRR	Memory Type and Range Registers
MUX	Multiplexer
NMI	Non-Maskable Interrupt
OD	Open-Drain
OPGA	Organic Pin Grid Array
PA	Physical Address
PBGA	Plastic Ball Grid Array
PCI	Peripheral Component Interconnect
PDE	Page Directory Entry
PDT	Page Directory Table
PGA	Pin Grid Array
PLL	Phase Locked Loop
PMSM	Power Management State Machine
POS	Power-On Suspend
POST	Power-On Self-Test
PP	Push-Pull
RAM	Random Access Memory
ROM	Read Only Memory
RXA	Read Acknowledge Queue
SCSI	Small Computer System Interface
SDI	System DRAM Interface
SDRAM	Synchronous Direct Random Access Memory
SIMD	Single Instruction Multiple Data
SIP	Serial Initialization Packet
SMBus	System Management Bus

Table 32. Acronyms (continued)

Abbreviation	Meaning
SPD	Serial Presence Detect
SRAM	Synchronous Random Access Memory
SROM	Serial Read Only Memory
TLB	Translation Lookaside Buffer
TOM	Top of Memory
TTL	Transistor Transistor Logic
VAS	Virtual Address Space
VPA	Virtual Page Address
VGA	Video Graphics Adapter
USB	Universal Serial Bus
ZDB	Zero Delay Buffer

Related Publications

These documents provide helpful information about the AMD Athlon™ XP processor model 8, and can be found with other related documents at the AMD Web site, <http://www.amd.com>.

- *AMD Athlon™ Processor x86 Code Optimization Guide*, order# 22007
- *AMD Processor Recognition Application Note*, order# 20734
- *Methodologies for Measuring Temperature on AMD Athlon™ and AMD Duron™ Processors*, order# 24228
- *AMD Thermal, Mechanical, and Chassis Cooling Design Guide*, order# 23794
- *Builders Guide for Desktop/Tower Systems*, order# 26003

Other Web sites of interest include the following:

- JEDEC home page—www.jedec.org
- IEEE home page—www.computer.org
- AGP Forum—www.agpforum.or



et4U.com

DataSheet4U.com