

## CDx4HCT4075 Triple 3-Input OR Gates

### 1 Features

- LSTTL input logic compatible
  - $V_{IL(max)} = 0.8\text{ V}$ ,  $V_{IH(min)} = 2\text{ V}$
- CMOS input logic compatible
  - $I_I \leq 1\ \mu\text{A}$  at  $V_{OL}$ ,  $V_{OH}$
- Buffered inputs
- 4.5 V to 5.5 V operation
- Wide operating temperature range:  $-55^\circ\text{C}$  to  $+125^\circ\text{C}$
- Supports fanout up to 10 LSTTL loads
- Significant power reduction compared to LSTTL logic ICs

### 2 Applications

- [User fewer inputs to monitor error signals](#)
- [Combine active-low enable signals](#)

### 3 Description

This device contains three independent 3-input OR gates. Each gate performs the Boolean function  $Y = A + B + C$  in positive logic.

#### Device Information<sup>(1)</sup>

PART NUMBER	PACKAGE	BODY SIZE (NOM)
CD74HCT4075E	PDIP (14)	19.30 mm × 6.40 mm
CD54HCT4075F	CDIP (14)	21.30 mm × 7.60 mm

- (1) For all available packages, see the orderable addendum at the end of the data sheet.

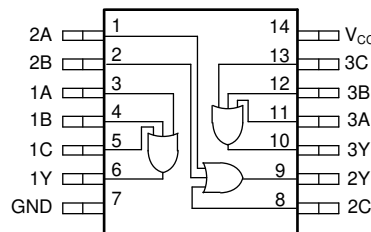

**Functional pinout**



## Table of Contents

<b>1 Features</b> .....	1	8.3 Feature Description.....	8
<b>2 Applications</b> .....	1	8.4 Device Functional Modes.....	9
<b>3 Description</b> .....	1	<b>9 Application and Implementation</b> .....	10
<b>4 Revision History</b> .....	2	9.1 Application Information.....	10
<b>5 Pin Configuration and Functions</b> .....	3	9.2 Typical Application.....	10
Pin Functions.....	3	<b>10 Power Supply Recommendations</b> .....	12
<b>6 Specifications</b> .....	4	<b>11 Layout</b> .....	13
6.1 Absolute Maximum Ratings.....	4	11.1 Layout Guidelines.....	13
6.2 Recommended Operating Conditions.....	4	11.2 Layout Example.....	13
6.3 Thermal Information.....	4	<b>12 Device and Documentation Support</b> .....	14
6.4 Electrical Characteristics.....	5	12.1 Documentation Support.....	14
6.5 Switching Characteristics.....	5	12.2 Support Resources.....	14
6.6 Operating Characteristics.....	5	12.3 Trademarks.....	14
6.7 Typical Characteristics.....	5	12.4 Electrostatic Discharge Caution.....	14
<b>7 Parameter Measurement Information</b> .....	7	12.5 Glossary.....	14
<b>8 Detailed Description</b> .....	8	<b>13 Mechanical, Packaging, and Orderable Information</b> .....	14
8.1 Overview.....	8		
8.2 Functional Block Diagram.....	8		

## 4 Revision History

DATE	REVISION	NOTES
June 2020	*	Initial release. Moved the HCT devices from the SCHS210 to a standalone data sheet.

## 5 Pin Configuration and Functions

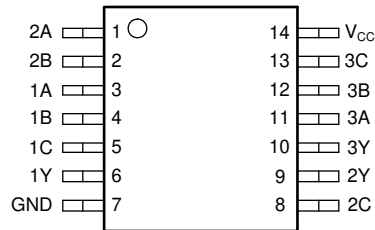

Figure 5-1. N or J Package 14-Pin PDIP or CDIP Top View

## Pin Functions

PIN		I/O	DESCRIPTION
NAME	NO.		
2A	1	Input	Channel 2, Input A
2B	2	Input	Channel 2, Input B
1A	3	Input	Channel 1, Input A
1B	4	Input	Channel 1, Input B
1C	5	Input	Channel 1, Input C
1Y	6	Output	Channel 1, Output Y
GND	7	—	Ground
2C	8	Input	Channel 2, Input C
2Y	9	Output	Channel 2, Output Y
3Y	10	Output	Channel 3, Output Y
3A	11	Input	Channel 3, Input A
3B	12	Input	Channel 3, Input B
3C	13	Input	Channel 3, Input C
V <sub>CC</sub>	14	—	Positive Supply

## 6 Specifications

### 6.1 Absolute Maximum Ratings

over operating free-air temperature range (unless otherwise noted)<sup>(1)</sup>

		MIN	MAX	UNIT
V <sub>CC</sub>	Supply voltage	-0.5	7	V
I <sub>IK</sub>	Input clamp current <sup>(2)</sup>	V <sub>I</sub> < -0.5 V or V <sub>I</sub> > V <sub>CC</sub> + 0.5 V		±20 mA
I <sub>OK</sub>	Output clamp current <sup>(2)</sup>	V <sub>O</sub> < -0.5 V or V <sub>O</sub> > V <sub>CC</sub> + 0.5 V		±20 mA
I <sub>O</sub>	Continuous output current	V <sub>O</sub> > -0.5 V or V <sub>O</sub> < V <sub>CC</sub> + 0.5 V		±25 mA
Continuous current through V <sub>CC</sub> or GND				±50 mA
T <sub>J</sub>	Junction temperature <sup>(3)</sup>	Plastic package		150
		Hermetic package or die		175
	Lead temperature (soldering 10s)	SOIC - lead tips only		300
T <sub>stg</sub>	Storage temperature	-65	150	°C

- (1) Stresses beyond those listed under *Absolute Maximum Rating* may cause permanent damage to the device. These are stress ratings only, which do not imply functional operation of the device at these or any other conditions beyond those indicated under *Recommended Operating Condition*. Exposure to absolute-maximum-rated conditions for extended periods may affect device reliability.
- (2) The input and output voltage ratings may be exceeded if the input and output current ratings are observed.
- (3) Guaranteed by design.

### 6.2 Recommended Operating Conditions

over operating free-air temperature range (unless otherwise noted)

		MIN	NOM	MAX	UNIT
V <sub>CC</sub>	Supply voltage	4.5		5.5	V
V <sub>IH</sub>	High-level input voltage	V <sub>CC</sub> = 4.5 V to 5.5 V		2	V
V <sub>IL</sub>	Low-level input voltage	V <sub>CC</sub> = 4.5 V to 5.5 V		0.8	V
V <sub>I</sub>	Input voltage	0		V <sub>CC</sub>	V
V <sub>O</sub>	Output voltage	0		V <sub>CC</sub>	V
t <sub>t</sub>	Input transition time	V <sub>CC</sub> = 4.5 V		500	ns
		V <sub>CC</sub> = 5.5 V		400	
T <sub>A</sub>	Operating free-air temperature	-55		125	°C

### 6.3 Thermal Information

THERMAL METRIC <sup>(1)</sup>		CD74HCT4075	UNIT
		N (PDIP)	
		14 PINS	
R <sub>θJA</sub>	Junction-to-ambient thermal resistance	61.2	°C/W
R <sub>θJC(top)</sub>	Junction-to-case (top) thermal resistance	48.9	°C/W
R <sub>θJB</sub>	Junction-to-board thermal resistance	40.9	°C/W
Ψ <sub>JT</sub>	Junction-to-top characterization parameter	28.6	°C/W
Ψ <sub>JB</sub>	Junction-to-board characterization parameter	40.7	°C/W
R <sub>θJC(bot)</sub>	Junction-to-case (bottom) thermal resistance	N/A	°C/W

- (1) For more information about traditional and new thermal metrics, see the [Semiconductor and IC Package Thermal Metrics](#) application report.

## 6.4 Electrical Characteristics

over operating free-air temperature range; typical values measured at  $T_A = 25^\circ\text{C}$  (unless otherwise noted).

PARAMETER	TEST CONDITIONS	$V_{CC}$	Operating free-air temperature ( $T_A$ )									UNIT		
			25°C			-40°C to 85°C			-55°C to 125°C					
			MIN	TYP	MAX	MIN	TYP	MAX	MIN	TYP	MAX			
$V_{OH}$	High-level output voltage	$V_I = V_{IH}$ or $V_{IL}$	$I_{OH} = -20 \mu\text{A}$	4.5 V	4.4			4.4			4.4			V
			$I_{OH} = -4 \text{ mA}$	4.5 V	3.98			3.84			3.7			
$V_{OL}$	Low-level output voltage	$V_I = V_{IH}$ or $V_{IL}$	$I_{OL} = 20 \mu\text{A}$	4.5 V				0.1			0.1			V
			$I_{OL} = 4 \text{ mA}$	4.5 V				0.26			0.4			
$I_I$	Input leakage current	$V_I = V_{CC}$ and GND	$I_O = 0$	5.5 V	$\pm 0.1$			$\pm 1$			$\pm 1$			$\mu\text{A}$
$I_{CC}$	Supply current	$V_I = V_{CC}$ or GND	$I_O = 0$	5.5 V	2			20			40			$\mu\text{A}$
$\Delta I_{CC}^{(1)}$	Additional Quiescent Device Current Per Input Pin.	$V_I = V_{CC} - 2.1$		4.5 V to 5.5 V	100 360			450			490			$\mu\text{A}$
$C_i$	Input capacitance			5 V	10			10			10			pF

(1) For dual-supply systems theoretical worst case ( $V_I = 2.4 \text{ V}$ ,  $V_{CC} = 5.5 \text{ V}$ ) specification is 1.8 mA.

## 6.5 Switching Characteristics

over operating free-air temperature range; typical values measured at  $T_A = 25^\circ\text{C}$  (unless otherwise noted).

PARAMETER	FROM	TO	TEST CONDITIONS	$V_{CC}$	Operating free-air temperature ( $T_A$ )									UNIT	
					25°C			-40°C to 85°C			-55°C to 125°C				
					MIN	TYP	MAX	MIN	TYP	MAX	MIN	TYP	MAX		
$t_{pd}$	Propagation delay	A or B	Y	$C_L = 50 \text{ pF}$	4.5 V	24			30			36			ns
		A or B	Y	$C_L = 15 \text{ pF}$	5 V	9									
$t_t$	Transition-time		Y	$C_L = 50 \text{ pF}$	4.5 V	15			19			22			ns

## 6.6 Operating Characteristics

over operating free-air temperature range; typical values measured at  $T_A = 25^\circ\text{C}$  (unless otherwise noted).

PARAMETER	TEST CONDITIONS	$V_{CC}$	MIN	TYP	MAX	UNIT
$C_{pd}$	Power dissipation capacitance per gate	No load		28		pF

## 6.7 Typical Characteristics

$T_A = 25^\circ\text{C}$

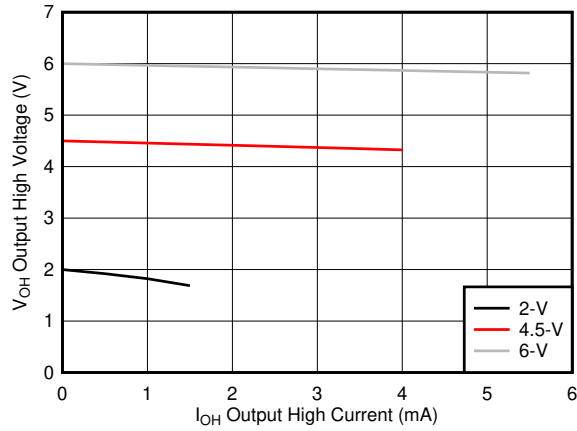

Figure 6-1. Typical output voltage in the high state ( $V_{OH}$ )

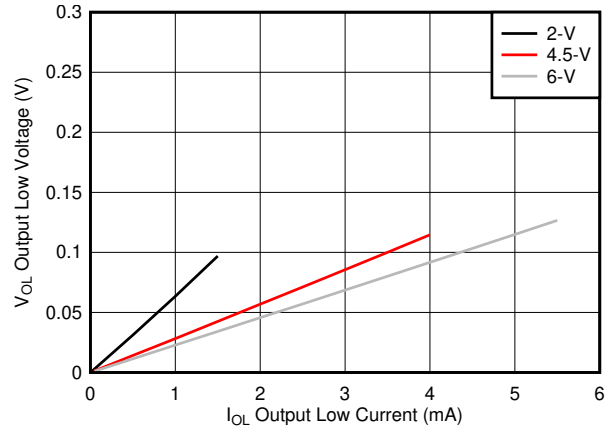

Figure 6-2. Typical output voltage in the low state ( $V_{OL}$ )

## 7 Parameter Measurement Information

- Phase relationships between waveforms were chosen arbitrarily. All input pulses are supplied by generators having the following characteristics:  $PRR \leq 1 \text{ MHz}$ ,  $Z_O = 50 \Omega$ ,  $t_t < 6 \text{ ns}$ .
- The outputs are measured one at a time, with one input transition per measurement.



A.  $C_L = 50 \text{ pF}$  and includes probe and jig capacitance.

**Figure 7-1. Load Circuit**



A.  $t_t$  is the greater of  $t_r$  and  $t_f$ .

**Figure 7-2. Voltage Waveforms Transition Times**



A. The maximum between  $t_{PLH}$  and  $t_{PHL}$  is used for  $t_{pd}$ .

**Figure 7-3. Voltage Waveforms Propagation Delays**

## 8 Detailed Description

### 8.1 Overview

This device contains three independent 3-input OR gates. Each gate performs the Boolean function  $Y = A + B + C$  in positive logic.

### 8.2 Functional Block Diagram

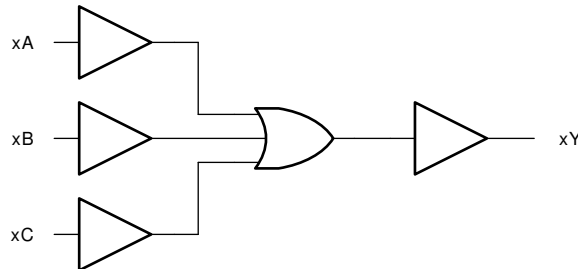

### 8.3 Feature Description

#### 8.3.1 Balanced CMOS Push-Pull Outputs

A balanced output allows the device to sink and source similar currents. The drive capability of this device may create fast edges into light loads so routing and load conditions should be considered to prevent ringing. Additionally, the outputs of this device are capable of driving larger currents than the device can sustain without being damaged. It is important for the output power of the device to be limited to avoid damage due to over-current. The electrical and thermal limits defined in the [Section 6.1](#) must be followed at all times.

The CD74HCT4075 can drive a load with a total capacitance less than or equal to the maximum load listed in the [Section 6.5](#) connected to a high-impedance CMOS input while still meeting all of the datasheet specifications. Larger capacitive loads can be applied, however it is not recommended to exceed the provided load value. If larger capacitive loads are required, it is recommended to add a series resistor between the output and the capacitor to limit output current to the values given in the [Section 6.1](#).

#### 8.3.2 TTL-Compatible CMOS Inputs

TTL-Compatible CMOS inputs are high impedance and are typically modeled as a resistor from the input to ground in parallel with the input capacitance given in the [Section 6.4](#). The worst case resistance is calculated with the maximum input voltage, given in the [Section 6.1](#), and the maximum input leakage current, given in the [Section 6.4](#), using ohm's law ( $R = V \div I$ ).

Signals applied to the inputs need to have fast edge rates, as defined by  $\Delta t/\Delta v$  in the [Section 6.2](#) to avoid excessive current consumption and oscillations. If a slow or noisy input signal is required, a device with a Schmitt-trigger input should be used to condition the input signal prior to the TTL-compatible CMOS input.

TTL-Compatible CMOS inputs have a lower threshold voltage than standard CMOS inputs to allow for compatibility with older bipolar logic devices. See the [Section 6.2](#) for the valid input voltages for the CD74HCT4075.



### 8.3.3 Clamp Diode Structure

The inputs and outputs to this device have both positive and negative clamping diodes as depicted in [Figure 8-1](#).

**CAUTION**

Voltages beyond the values specified in the [Section 6.1](#) table can cause damage to the device. The recommended input and output voltage ratings may be exceeded if the input and output clamp-current ratings are observed.



**Figure 8-1. Electrical Placement of Clamping Diodes for Each Input and Output**

### 8.4 Device Functional Modes

**Table 8-1. Function Table**

INPUTS			OUTPUT
A	B	C	Y
L	L	L	L
H	X	X	H
X	H	X	H
X	X	H	H

## 9 Application and Implementation

### Note

Information in the following applications sections is not part of the TI component specification, and TI does not warrant its accuracy or completeness. TI's customers are responsible for determining suitability of components for their purposes, as well as validating and testing their design implementation to confirm system functionality.

### 9.1 Application Information

In this application, one 3-input OR gates is used to combine overhear signals to control a fan as shown in [Figure 9-1](#). The other two gates can be used for another application in the system, or the inputs can be grounded and the channels left unused.

This device is used to directly control the Enable pin of a fan driver. The fan driver requires only one input signal to be HIGH before being enabled, and should be disabled in the event that all signals go LOW. The 4-input OR gate function combines the four individual overhear signals into a single active-high enable signal.

### 9.2 Typical Application

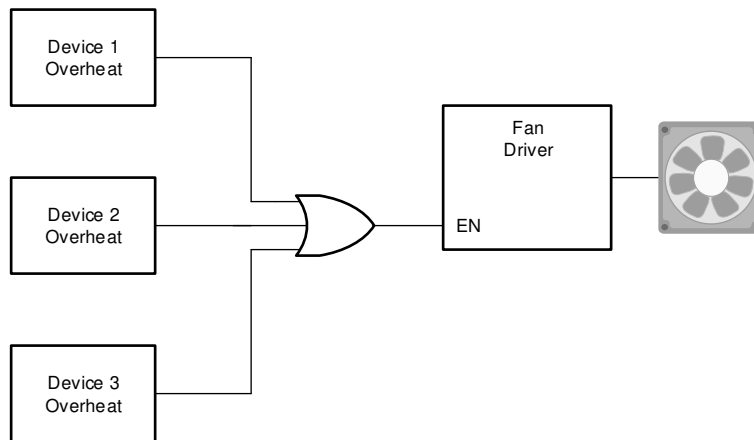

Figure 9-1. Typical application schematic

#### 9.2.1 Design Requirements

##### 9.2.1.1 Power Considerations

Ensure the desired supply voltage is within the range specified in the [Section 6.2](#). The supply voltage sets the device's electrical characteristics as described in the [Section 6.4](#).

The supply must be capable of sourcing current equal to the total current to be sourced by all outputs of the CD74HCT4075 plus the maximum supply current,  $I_{CC}$ , listed in the [Section 6.4](#). The logic device can only source or sink as much current as it is provided at the supply and ground pins, respectively. Be sure not to exceed the maximum total current through GND or  $V_{CC}$  listed in the [Section 6.1](#).

Total power consumption can be calculated using the information provided in [CMOS Power Consumption and  \$C\_{pd}\$  Calculation](#).

Thermal increase can be calculated using the information provided in [Thermal Characteristics of Standard Linear and Logic \(SLL\) Packages and Devices](#).

### CAUTION

The maximum junction temperature,  $T_{J(max)}$  listed in the [Section 6.1](#), is an *additional limitation* to prevent damage to the device. Do not violate any values listed in the [Section 6.1](#). These limits are provided to prevent damage to the device.

#### 9.2.1.2 Input Considerations

Unused inputs must be terminated to either  $V_{CC}$  or ground. These can be directly terminated if the input is completely unused, or they can be connected with a pull-up or pull-down resistor if the input is to be used sometimes, but not always. A pull-up resistor is used for a default state of HIGH, and a pull-down resistor is used for a default state of LOW. The resistor size is limited by drive current of the controller, leakage current into the CD74HCT4075, as specified in the [Section 6.4](#), and the desired input transition rate. A 10-k $\Omega$  resistor value is often used due to these factors.

Refer to the [Section 8.3](#) for additional information regarding the inputs for this device.

#### 9.2.1.3 Output Considerations

The positive supply voltage is used to produce the output HIGH voltage. Drawing current from the output will decrease the output voltage as specified by the  $V_{OH}$  specification in the [Section 6.4](#). Similarly, the ground voltage is used to produce the output LOW voltage. Sinking current into the output will increase the output voltage as specified by the  $V_{OL}$  specification in the [Section 6.4](#).

Unused outputs can be left floating. Do not connect outputs directly to  $V_{CC}$  or ground.

Refer to [Section 8.3](#) for additional information regarding the outputs for this device.

#### 9.2.2 Detailed Design Procedure

1. Add a decoupling capacitor from  $V_{CC}$  to GND. The capacitor needs to be placed physically close to the device and electrically close to both the  $V_{CC}$  and GND pins. An example layout is shown in the [Section 11](#).
2. Ensure the capacitive load at the output is  $\leq 70$  pF. This is not a hard limit, however it will ensure optimal performance. This can be accomplished by providing short, appropriately sized traces from the CD74HCT4075 to the receiving device.
3. Ensure the resistive load at the output is larger than  $(V_{CC} / I_{O(max)}) \Omega$ . This will ensure that the maximum output current from the [Section 6.1](#) is not violated. Most CMOS inputs have a resistive load measured in megaohms; much larger than the minimum calculated above.
4. Thermal issues are rarely a concern for logic gates, however the power consumption and thermal increase can be calculated using the steps provided in the application report, [CMOS Power Consumption and Cpd Calculation](#)

#### 9.2.3 Application Curves

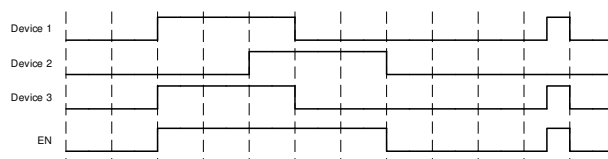

**Figure 9-2. Typical application timing diagram**

## 10 Power Supply Recommendations

The power supply can be any voltage between the minimum and maximum supply voltage rating located in the [Section 6.2](#). Each  $V_{CC}$  terminal should have a bypass capacitor to prevent power disturbance. A 0.1- $\mu\text{F}$  capacitor is recommended for this device. It is acceptable to parallel multiple bypass caps to reject different frequencies of noise. The 0.1- $\mu\text{F}$  and 1- $\mu\text{F}$  capacitors are commonly used in parallel. The bypass capacitor should be installed as close to the power terminal as possible for best results, as shown in [Figure 11-1](#).

## 11 Layout

### 11.1 Layout Guidelines

When using multiple-input and multiple-channel logic devices inputs must not ever be left floating. In many cases, functions or parts of functions of digital logic devices are unused; for example, when only two inputs of a triple-input AND gate are used. Such unused input pins must not be left unconnected because the undefined voltages at the outside connections result in undefined operational states. All unused inputs of digital logic devices must be connected to a logic high or logic low voltage, as defined by the input voltage specifications, to prevent them from floating. The logic level that must be applied to any particular unused input depends on the function of the device. Generally, the inputs are tied to GND or  $V_{CC}$ , whichever makes more sense for the logic function or is more convenient.

### 11.2 Layout Example

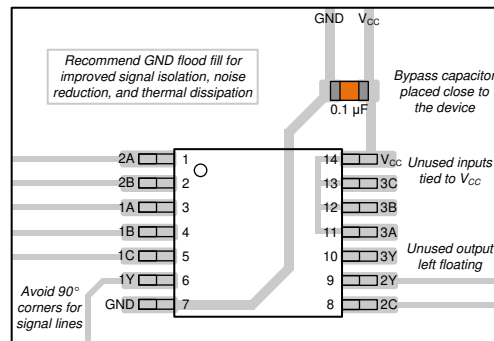

**Figure 11-1. Example layout for the CD74HCT4075**

## 12 Device and Documentation Support

### 12.1 Documentation Support

#### 12.1.1 Related Documentation

For related documentation see the following:

- [HCMOS Design Considerations](#)
- [CMOS Power Consumption and CPD Calculation](#)
- [Designing with Logic](#)

### 12.2 Support Resources

[TI E2E™ support forums](#) are an engineer's go-to source for fast, verified answers and design help — straight from the experts. Search existing answers or ask your own question to get the quick design help you need.

Linked content is provided "AS IS" by the respective contributors. They do not constitute TI specifications and do not necessarily reflect TI's views; see TI's [Terms of Use](#).

### 12.3 Trademarks

TI E2E™ is a trademark of Texas Instruments.  
All trademarks are the property of their respective owners.

### 12.4 Electrostatic Discharge Caution



This integrated circuit can be damaged by ESD. Texas Instruments recommends that all integrated circuits be handled with appropriate precautions. Failure to observe proper handling and installation procedures can cause damage.

ESD damage can range from subtle performance degradation to complete device failure. Precision integrated circuits may be more susceptible to damage because very small parametric changes could cause the device not to meet its published specifications.

### 12.5 Glossary

[TI Glossary](#) This glossary lists and explains terms, acronyms, and definitions.

## 13 Mechanical, Packaging, and Orderable Information

The following pages include mechanical, packaging, and orderable information. This information is the most current data available for the designated devices. This data is subject to change without notice and revision of this document. For browser-based versions of this data sheet, refer to the left-hand navigation.

**PACKAGING INFORMATION**

Orderable Device	Status (1)	Package Type	Package Drawing	Pins	Package Qty	Eco Plan (2)	Lead finish/ Ball material (6)	MSL Peak Temp (3)	Op Temp (°C)	Device Marking (4/5)	Samples
CD54HCT4075F3A	ACTIVE	CDIP	J	14	1	Non-RoHS & Green	SNPB	N / A for Pkg Type	-55 to 125	CD54HCT4075F3A	<a href="#">Samples</a>
CD74HCT4075E	ACTIVE	PDIP	N	14	25	RoHS & Green	NIPDAU	N / A for Pkg Type	-55 to 125	CD74HCT4075E	<a href="#">Samples</a>

(1) The marketing status values are defined as follows:

**ACTIVE:** Product device recommended for new designs.

**LIFEBUY:** TI has announced that the device will be discontinued, and a lifetime-buy period is in effect.

**NRND:** Not recommended for new designs. Device is in production to support existing customers, but TI does not recommend using this part in a new design.

**PREVIEW:** Device has been announced but is not in production. Samples may or may not be available.

**OBSELETE:** TI has discontinued the production of the device.

(2) **RoHS:** TI defines "RoHS" to mean semiconductor products that are compliant with the current EU RoHS requirements for all 10 RoHS substances, including the requirement that RoHS substance do not exceed 0.1% by weight in homogeneous materials. Where designed to be soldered at high temperatures, "RoHS" products are suitable for use in specified lead-free processes. TI may reference these types of products as "Pb-Free".

**RoHS Exempt:** TI defines "RoHS Exempt" to mean products that contain lead but are compliant with EU RoHS pursuant to a specific EU RoHS exemption.

**Green:** TI defines "Green" to mean the content of Chlorine (Cl) and Bromine (Br) based flame retardants meet JS709B low halogen requirements of <=1000ppm threshold. Antimony trioxide based flame retardants must also meet the <=1000ppm threshold requirement.

(3) MSL, Peak Temp. - The Moisture Sensitivity Level rating according to the JEDEC industry standard classifications, and peak solder temperature.

(4) There may be additional marking, which relates to the logo, the lot trace code information, or the environmental category on the device.

(5) Multiple Device Markings will be inside parentheses. Only one Device Marking contained in parentheses and separated by a "-" will appear on a device. If a line is indented then it is a continuation of the previous line and the two combined represent the entire Device Marking for that device.

(6) Lead finish/Ball material - Orderable Devices may have multiple material finish options. Finish options are separated by a vertical ruled line. Lead finish/Ball material values may wrap to two lines if the finish value exceeds the maximum column width.

**Important Information and Disclaimer:**The information provided on this page represents TI's knowledge and belief as of the date that it is provided. TI bases its knowledge and belief on information provided by third parties, and makes no representation or warranty as to the accuracy of such information. Efforts are underway to better integrate information from third parties. TI has taken and continues to take reasonable steps to provide representative and accurate information but may not have conducted destructive testing or chemical analysis on incoming materials and chemicals. TI and TI suppliers consider certain information to be proprietary, and thus CAS numbers and other limited information may not be available for release.

In no event shall TI's liability arising out of such information exceed the total purchase price of the TI part(s) at issue in this document sold by TI to Customer on an annual basis.

**OTHER QUALIFIED VERSIONS OF CD54HCT4075, CD74HCT4075 :**

- Catalog: [CD74HCT4075](#)
- Military: [CD54HCT4075](#)

## NOTE: Qualified Version Definitions:

- Catalog - TI's standard catalog product
- Military - QML certified for Military and Defense Applications



**TUBE**

\*All dimensions are nominal

Device	Package Name	Package Type	Pins	SPQ	L (mm)	W (mm)	T (μm)	B (mm)
CD74HCT4075E	N	PDIP	14	25	506	13.97	11230	4.32
CD74HCT4075E	N	PDIP	14	25	506	13.97	11230	4.32

J 14

**GENERIC PACKAGE VIEW**  
**CDIP - 5.08 mm max height**  
CERAMIC DUAL IN LINE PACKAGE



Images above are just a representation of the package family, actual package may vary.  
Refer to the product data sheet for package details.

4040083-5/G

J0014A



# PACKAGE OUTLINE

CDIP - 5.08 mm max height

CERAMIC DUAL IN LINE PACKAGE



4214771/A 05/2017

**NOTES:**

1. All controlling linear dimensions are in inches. Dimensions in brackets are in millimeters. Any dimension in brackets or parenthesis are for reference only. Dimensioning and tolerancing per ASME Y14.5M.
2. This drawing is subject to change without notice.
3. This package is hermetically sealed with a ceramic lid using glass frit.
4. Index point is provided on cap for terminal identification only and on press ceramic glass frit seal only.
5. Falls within MIL-STD-1835 and GDIP1-T14.

# EXAMPLE BOARD LAYOUT

J0014A

CDIP - 5.08 mm max height

CERAMIC DUAL IN LINE PACKAGE



LAND PATTERN EXAMPLE  
NON-SOLDER MASK DEFINED  
SCALE: 5X



4214771/A 05/2017

N (R-PDIP-T\*\*)

PLASTIC DUAL-IN-LINE PACKAGE

16 PINS SHOWN



- NOTES:
- A. All linear dimensions are in inches (millimeters).
  - B. This drawing is subject to change without notice.
  - Falls within JEDEC MS-001, except 18 and 20 pin minimum body length (Dim A).
  - The 20 pin end lead shoulder width is a vendor option, either half or full width.

## IMPORTANT NOTICE AND DISCLAIMER

TI PROVIDES TECHNICAL AND RELIABILITY DATA (INCLUDING DATA SHEETS), DESIGN RESOURCES (INCLUDING REFERENCE DESIGNS), APPLICATION OR OTHER DESIGN ADVICE, WEB TOOLS, SAFETY INFORMATION, AND OTHER RESOURCES "AS IS" AND WITH ALL FAULTS, AND DISCLAIMS ALL WARRANTIES, EXPRESS AND IMPLIED, INCLUDING WITHOUT LIMITATION ANY IMPLIED WARRANTIES OF MERCHANTABILITY, FITNESS FOR A PARTICULAR PURPOSE OR NON-INFRINGEMENT OF THIRD PARTY INTELLECTUAL PROPERTY RIGHTS.

These resources are intended for skilled developers designing with TI products. You are solely responsible for (1) selecting the appropriate TI products for your application, (2) designing, validating and testing your application, and (3) ensuring your application meets applicable standards, and any other safety, security, regulatory or other requirements.

These resources are subject to change without notice. TI grants you permission to use these resources only for development of an application that uses the TI products described in the resource. Other reproduction and display of these resources is prohibited. No license is granted to any other TI intellectual property right or to any third party intellectual property right. TI disclaims responsibility for, and you will fully indemnify TI and its representatives against, any claims, damages, costs, losses, and liabilities arising out of your use of these resources.

TI's products are provided subject to [TI's Terms of Sale](#) or other applicable terms available either on [ti.com](https://www.ti.com) or provided in conjunction with such TI products. TI's provision of these resources does not expand or otherwise alter TI's applicable warranties or warranty disclaimers for TI products.

TI objects to and rejects any additional or different terms you may have proposed.

Mailing Address: Texas Instruments, Post Office Box 655303, Dallas, Texas 75265  
Copyright © 2023, Texas Instruments Incorporated