

### FEATURES

- 10µs Short Circuit Withstand
- High Thermal Cycling Capability
- Non Punch Through Silicon
- Isolated AISiC Base with AlN Substrates
- Lead Free construction

### APPLICATIONS

- High Reliability Inverters
- Motor Controllers
- Traction Drives

The Powerline range of high power modules includes half bridge, chopper, dual, single and bi-directional switch configurations covering voltages from 1200V to 6500V and currents up to 2400A.

The DIM1600NSM17-A000 is a single switch 1700V, n-channel enhancement mode, insulated gate bipolar transistor (IGBT) module. The IGBT has a wide reverse bias safe operating area (RBSOA) plus 10µs short circuit withstand. This device is optimised for traction drives and other applications requiring high thermal cycling capability.

The module incorporates an electrically isolated base plate and low inductance construction enabling circuit designers to optimise circuit layouts and utilise grounded heat sinks for safety.

### ORDERING INFORMATION

Order As:

### DIM1600NSM17-A000

Note: When ordering, please use the complete part number

### KEY PARAMETERS

$V_{CES}$	<b>1700V</b>
$V_{CE(sat)}$ * (typ)	<b>2.7V</b>
$I_C$ (max)	<b>1600A</b>
$I_{C(PK)}$ (max)	<b>3200A</b>

\* Measured at the power busbars, not the auxiliary terminals

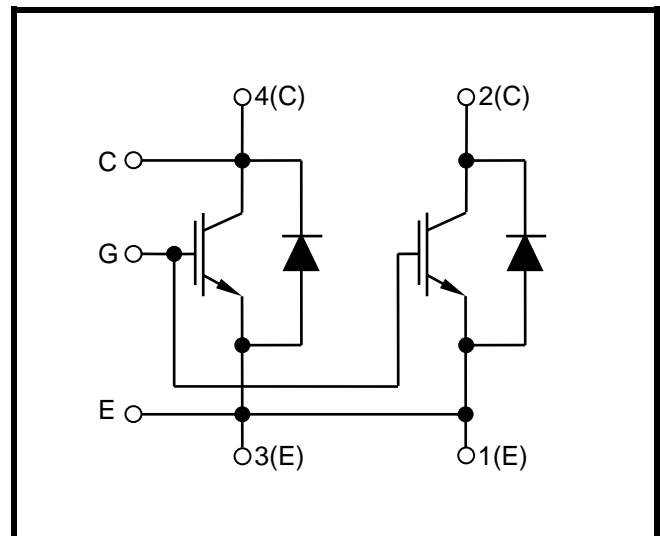

Fig. 1 Circuit configuration



Outline type code: N

(See Fig. 11 for further information)

Fig. 2 Package

**ABSOLUTE MAXIMUM RATINGS**

Stresses above those listed under ‘Absolute Maximum Ratings’ may cause permanent damage to the device. In extreme conditions, as with all semiconductors, this may include potentially hazardous rupture of the package. Appropriate safety precautions should always be followed. Exposure to Absolute Maximum Ratings may affect device reliability.

**T<sub>case</sub> = 25°C unless stated otherwise**

Symbol	Parameter	Test Conditions	Max.	Units
V <sub>CES</sub>	Collector-emitter voltage	V <sub>GE</sub> = 0V	1700	V
V <sub>GES</sub>	Gate-emitter voltage		±20	V
I <sub>C</sub>	Continuous collector current	T <sub>case</sub> = 75°C	1600	A
I <sub>C(PK)</sub>	Peak collector current	1ms, T <sub>case</sub> = 110°C	3200	A
P <sub>max</sub>	Max. transistor power dissipation	T <sub>case</sub> = 25°C, T <sub>j</sub> = 150°C	13890	W
I <sup>2</sup> t	Diode I <sup>2</sup> t value	V <sub>R</sub> = 0, t <sub>p</sub> = 10ms, T <sub>j</sub> = 125°C	480	kA <sup>2</sup> s
V <sub>isol</sub>	Isolation voltage – per module	Commoned terminals to base plate. AC RMS, 1 min, 50Hz	4000	V
Q <sub>PD</sub>	Partial discharge – per module	IEC1287, V <sub>1</sub> = 1800V, V <sub>2</sub> = 1300V, 50Hz RMS	10	pC

**THERMAL AND MECHANICAL RATINGS**

Internal insulation material: AIN  
 Baseplate material: AISiC  
 Creepage distance: 33mm  
 Clearance: 20mm  
 CTI (Comparative Tracking Index): >600

Symbol	Parameter	Test Conditions	Min	Typ.	Max	Units
R <sub>th(j-c)</sub>	Thermal resistance – transistor	Continuous dissipation - junction to case	-	-	9	°C/kW
R <sub>th(j-c)</sub>	Thermal resistance – diode	Continuous dissipation - junction to case	-	-	20	°C/kW
R <sub>th(c-h)</sub>	Thermal resistance – case to heatsink (per module)	Mounting torque 5Nm (with mounting grease)	-	-	8	°C/kW
T <sub>j</sub>	Junction temperature	Transistor	-	-	150	°C
		Diode	-	-	125	°C
T <sub>stg</sub>	Storage temperature range	-	-40	-	125	°C
	Screw torque	Mounting – M6	-	-	5	Nm
		Electrical connections – M4	-	-	2	Nm
		Electrical connections – M8	-	-	10	Nm

**ELECTRICAL CHARACTERISTICS**

$T_{case} = 25^{\circ}C$  unless stated otherwise.

Symbol	Parameter	Test Conditions	Min	Typ	Max	Units
$I_{CES}$	Collector cut-off current	$V_{GE} = 0V, V_{CE} = V_{CES}$			2	mA
		$V_{GE} = 0V, V_{CE} = V_{CES}, T_{case} = 125^{\circ}C$			50	mA
$I_{GES}$	Gate leakage current	$V_{GE} = \pm 20V, V_{CE} = 0V$			8	$\mu A$
$V_{GE(TH)}$	Gate threshold voltage	$I_C = 80mA, V_{GE} = V_{CE}$	4.5	5.5	6.5	V
$V_{CE(sat)}^{\dagger}$	Collector-emitter saturation voltage	$V_{GE} = 15V, I_C = 1600A$		2.7	3.2	V
		$V_{GE} = 15V, I_C = 1600A, T_j = 125^{\circ}C$		3.4	4.0	V
$I_F$	Diode forward current	DC			1600	A
$I_{FM}$	Diode maximum forward current	$t_p = 1ms$			3200	A
$V_F^{\dagger}$	Diode forward voltage	$I_F = 1600A$		2.2	2.5	V
		$I_F = 1600A, T_j = 125^{\circ}C$		2.3	2.6	V
$C_{ies}$	Input capacitance	$V_{CE} = 25V, V_{GE} = 0V, f = 1MHz$		120		nF
$Q_g$	Gate charge	$\pm 15V$		18		$\mu C$
$C_{res}$	Reverse transfer capacitance	$V_{CE} = 25V, V_{GE} = 0V, f = 1MHz$				nF
$L_M$	Module inductance			15		nH
$R_{INT}$	Internal transistor resistance			140		$\mu\Omega$
$SC_{Data}$	Short circuit current, $I_{SC}$	$T_j = 125^{\circ}C, V_{CC} = 1000V$ $t_p \leq 10\mu s, V_{GE} \leq 15V$ $V_{CE(max)} = V_{CES} - L^* \times di/dt$ IEC 60747-9		6400		A

**Note:**

$\dagger$  Measured at the power busbars, not the auxiliary terminals

\* L is the circuit inductance +  $L_M$

**ELECTRICAL CHARACTERISTICS**

**T<sub>case</sub> = 25°C unless stated otherwise**

Symbol	Parameter	Test Conditions	Min	Typ.	Max	Units	
t <sub>d(off)</sub>	Turn-off delay time	I <sub>C</sub> = 1600A V <sub>GE</sub> = ±15V V <sub>CE</sub> = 900V R <sub>G(ON)</sub> = 1.5Ω R <sub>G(OFF)</sub> = 1.5Ω L <sub>S</sub> ~ 100nH		1400		ns	
t <sub>f</sub>	Fall time			200		ns	
E <sub>OFF</sub>	Turn-off energy loss				550		mJ
t <sub>d(on)</sub>	Turn-on delay time				300		ns
t <sub>r</sub>	Rise time				200		ns
E <sub>ON</sub>	Turn-on energy loss				300		mJ
Q <sub>rr</sub>	Diode reverse recovery charge	I <sub>F</sub> = 1600A V <sub>CE</sub> = 900V di <sub>F</sub> /dt = 8000A/μs		400		μC	
I <sub>rr</sub>	Diode reverse recovery current			1000		A	
E <sub>rec</sub>	Diode reverse recovery energy				265		mJ

**T<sub>case</sub> = 125°C unless stated otherwise**

Symbol	Parameter	Test Conditions	Min	Typ.	Max	Units	
t <sub>d(off)</sub>	Turn-off delay time	I <sub>C</sub> = 1600A V <sub>GE</sub> = ±15V V <sub>CE</sub> = 900V R <sub>G(ON)</sub> = 1.5Ω R <sub>G(OFF)</sub> = 1.5Ω L <sub>S</sub> ~ 100nH		1600		ns	
t <sub>f</sub>	Fall time			250		ns	
E <sub>OFF</sub>	Turn-off energy loss				720		mJ
t <sub>d(on)</sub>	Turn-on delay time				400		ns
t <sub>r</sub>	Rise time				250		ns
E <sub>ON</sub>	Turn-on energy loss				600		mJ
Q <sub>rr</sub>	Diode reverse recovery charge	I <sub>F</sub> = 1600A V <sub>CE</sub> = 900V di <sub>F</sub> /dt = 7000A/μs		600		μC	
I <sub>rr</sub>	Diode reverse recovery current			1050		A	
E <sub>rec</sub>	Diode reverse recovery energy				530		mJ

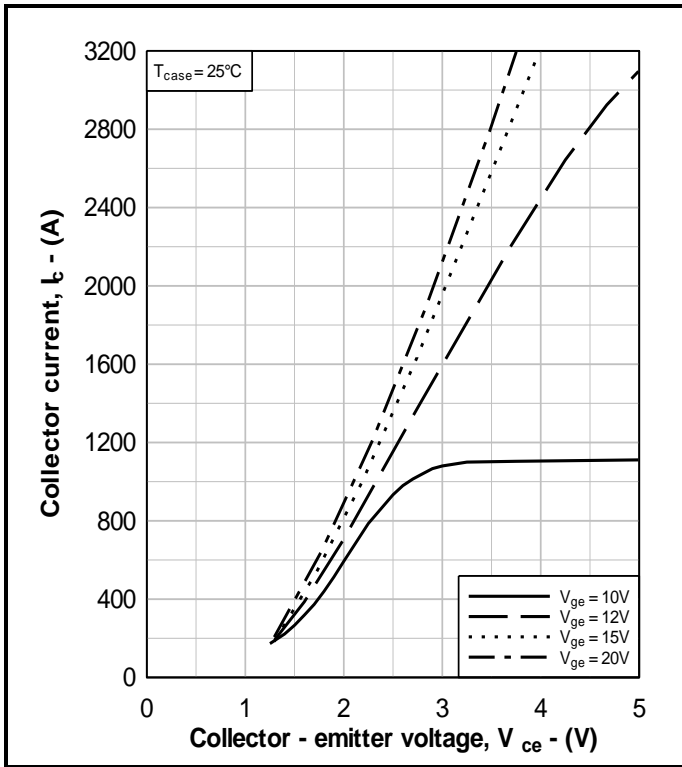

Fig. 3 Typical output characteristics

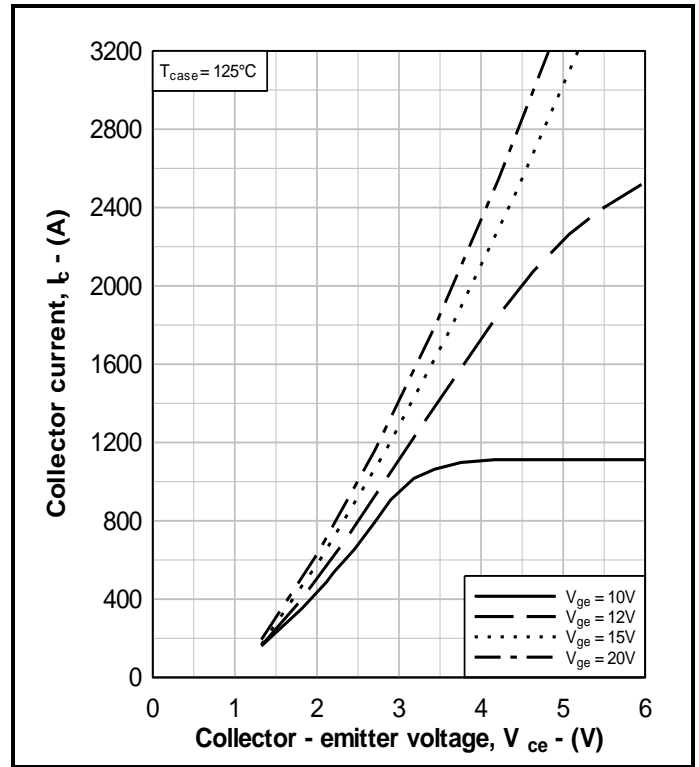

Fig. 4 Typical output characteristics

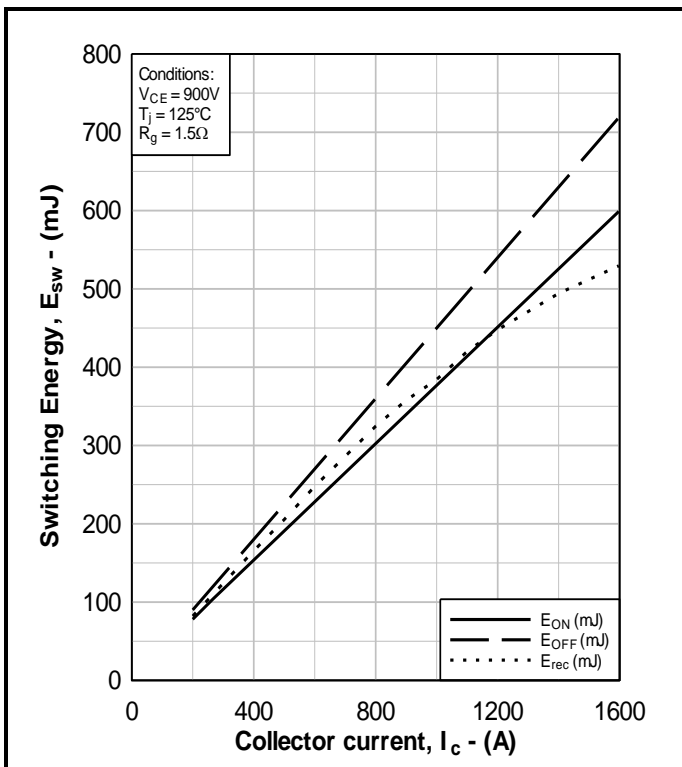

Fig. 5 Typical switching energy vs collector current

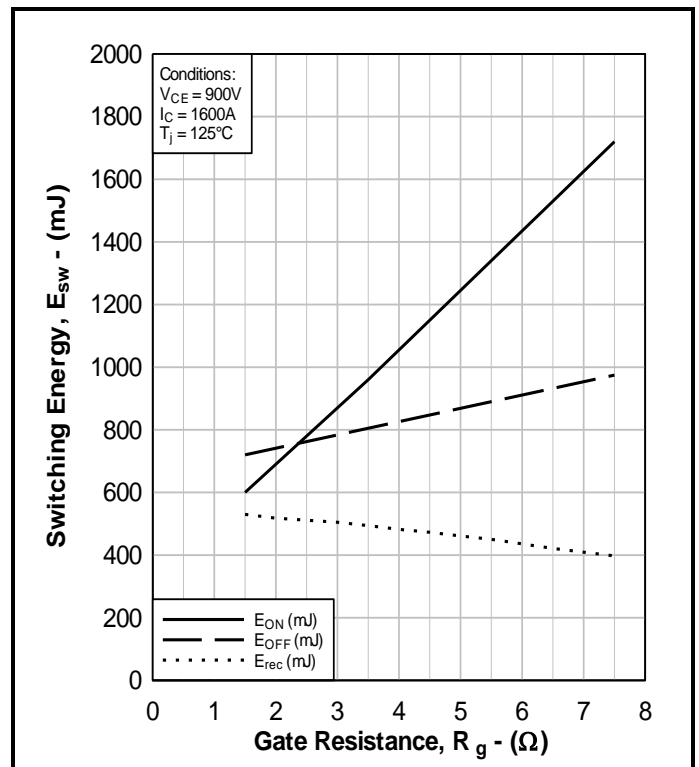

Fig. 6 Typical switching energy vs gate resistance

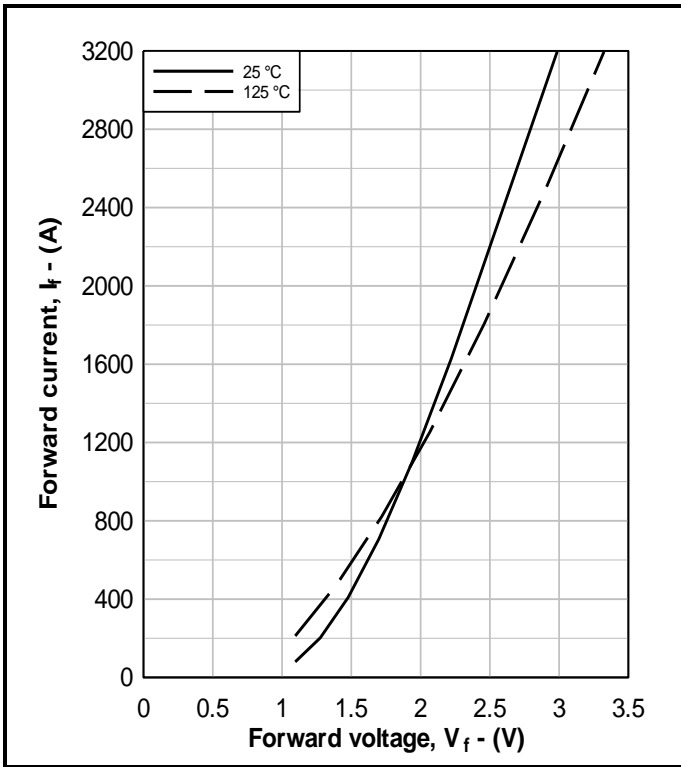

Fig. 7 Diode typical forward characteristics

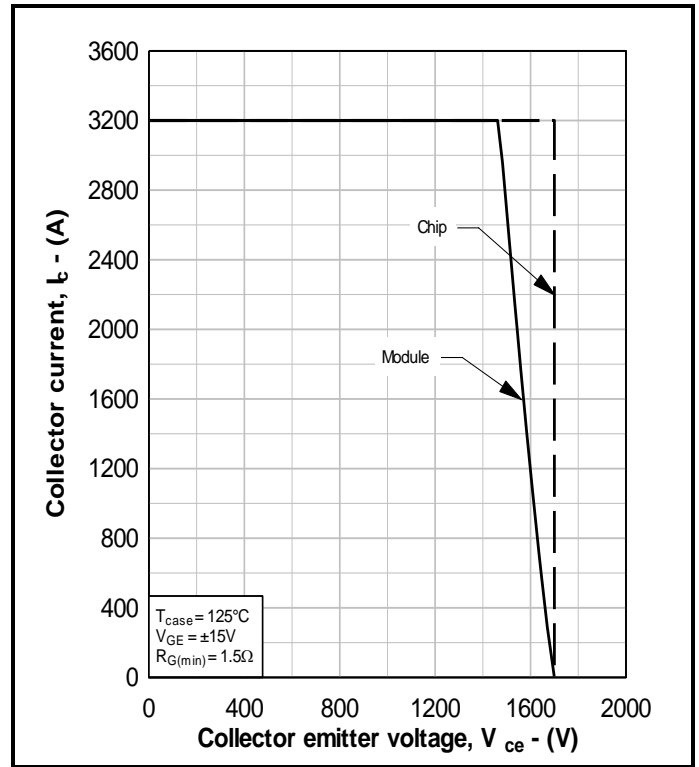

Fig. 8 Reverse bias safe operating area

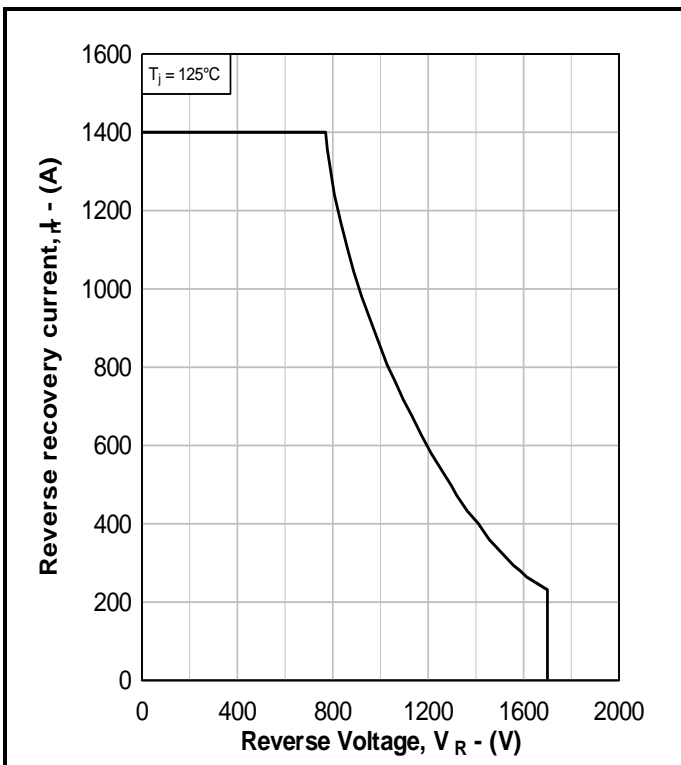

Fig. 9 Diode reverse bias safe operating area

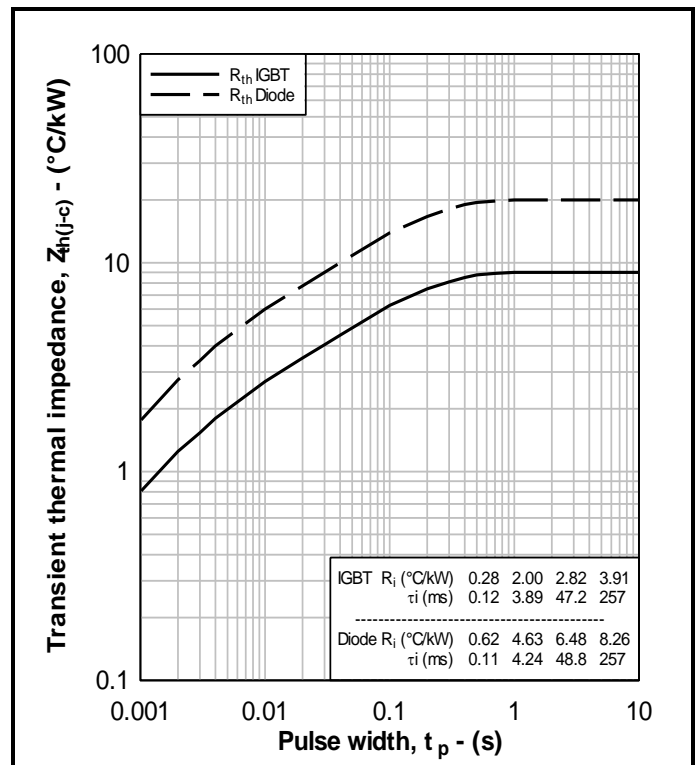
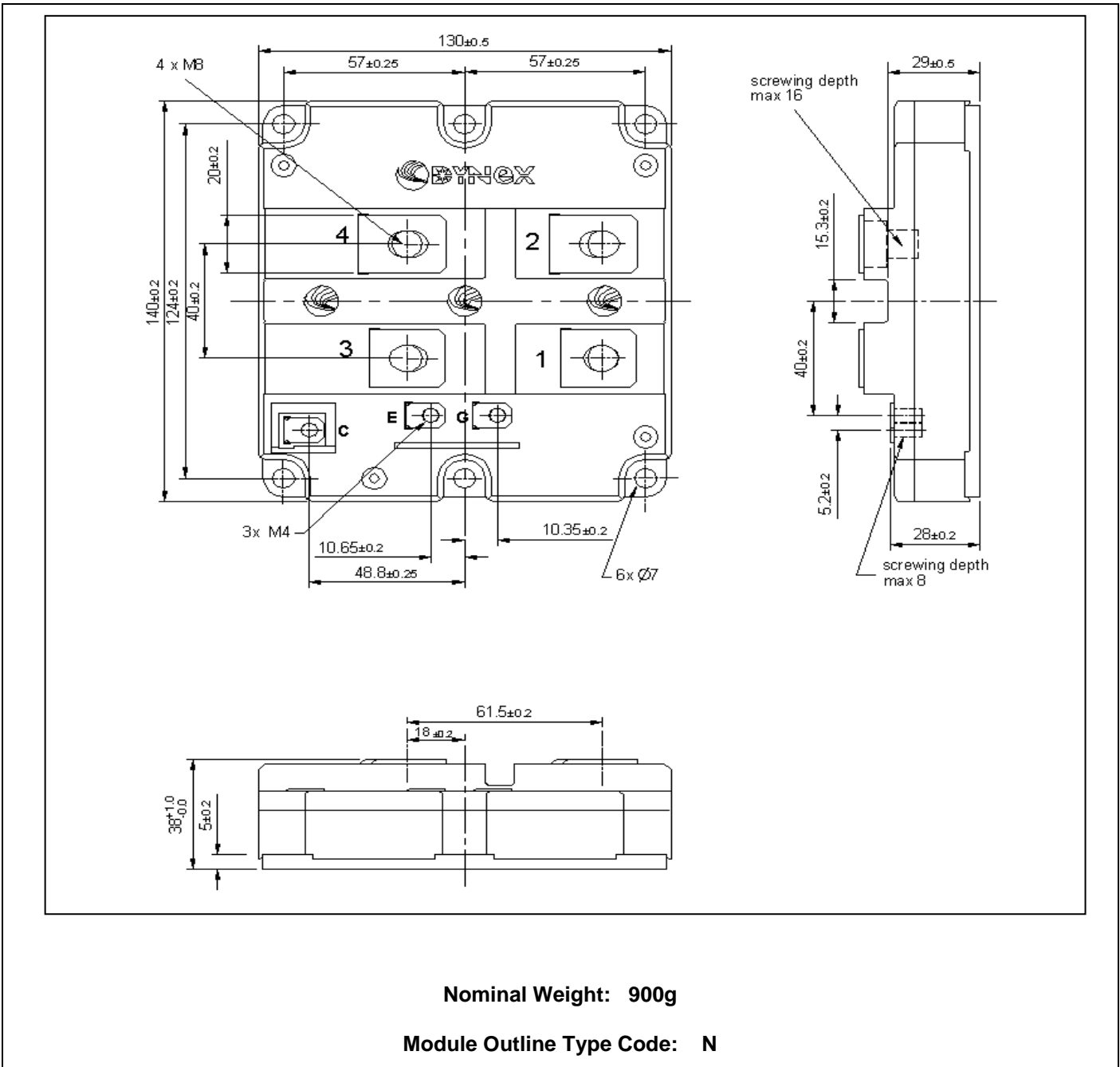

Fig. 10 Transient thermal impedance

**PACKAGE DETAILS**

For further package information, please visit our website or contact Customer Services.  
 All dimensions in mm, unless stated otherwise.  
**DO NOT SCALE.**



**Nominal Weight: 900g**

**Module Outline Type Code: N**

**Fig. 11 Module outline drawing**

**IMPORTANT INFORMATION:**

This publication is provided for information only and not for resale.

The products and information in this publication are intended for use by appropriately trained technical personnel.

Due to the diversity of product applications, the information contained herein is provided as a general guide only and does not constitute any guarantee of suitability for use in a specific application. The user must evaluate the suitability of the product and the completeness of the product data for the application. The user is responsible for product selection and ensuring all safety and any warning requirements are met. Should additional product information be needed please contact Customer Service.

Although we have endeavoured to carefully compile the information in this publication it may contain inaccuracies or typographical errors. The information is provided without any warranty or guarantee of any kind.

This publication is an uncontrolled document and is subject to change without notice. When referring to it please ensure that it is the most up to date version and has not been superseded.

The products are not intended for use in applications where a failure or malfunction may cause loss of life, injury or damage to property. The user must ensure that appropriate safety precautions are taken to prevent or mitigate the consequences of a product failure or malfunction.

The products must not be touched when operating because there is a danger of electrocution or severe burning. Always use protective safety equipment such as appropriate shields for the product and wear safety glasses. Even when disconnected any electric charge remaining in the product must be discharged and allowed to cool before safe handling using protective gloves.

Extended exposure to conditions outside the product ratings may affect reliability leading to premature product failure. Use outside the product ratings is likely to cause permanent damage to the product. In extreme conditions, as with all semiconductors, this may include potentially hazardous rupture, a large current to flow or high voltage arcing, resulting in fire or explosion. Appropriate application design and safety precautions should always be followed to protect persons and property.

**Product Status & Product Ordering:**

We annotate datasheets in the top right hand corner of the front page, to indicate product status if it is not yet fully approved for production. The annotations are as follows:-

- Target Information:** This is the most tentative form of information and represents a very preliminary specification. No actual design work on the product has been started.
- Preliminary Information:** The product design is complete and final characterisation for volume production is in progress. The datasheet represents the product as it is now understood but details may change.
- No Annotation:** The product has been approved for production and unless otherwise notified by Dynex any product ordered will be supplied to the **current version of the data sheet prevailing at the time of our order acknowledgement.**

All products and materials are sold and services provided subject to Dynex's conditions of sale, which are available on request.

Any brand names and product names used in this publication are trademarks, registered trademarks or trade names of their respective owners.

**HEADQUARTERS OPERATIONS**

**DYNEX SEMICONDUCTOR LTD**

Doddington Road, Lincoln, Lincolnshire, LN6 3LF,  
United Kingdom

Fax: +44(0)1522 500550

Tel: +44(0)1522 500500

Web: <http://www.dynexsemi.com>

**CUSTOMER SERVICE**

**DYNEX SEMICONDUCTOR LTD**

Doddington Road, Lincoln, Lincolnshire, LN6 3LF,  
United Kingdom

Tel: +44(0)1522 502753 / 502901

Email: [powersolutions@dynexsemi.com](mailto:powersolutions@dynexsemi.com)