

ORDERING INFORMATION

Part Number	Package
IRF40N03	TO-220

ELECTRICAL CHARACTERISTICS

Unless otherwise specified, $T_J = 25^\circ\text{C}$.

Characteristic		Symbol	IRF40N03			Units
			Min	Typ	Max	
OFF Characteristics						
Drain-to-Source Breakdown Voltage ($V_{GS} = 0\text{ V}$, $I_D = 250\ \mu\text{A}$)		V_{DSS}	30			V
Breakdown Voltage Temperature Coefficient (Reference to 25°C , $I_D = 1\text{ mA}$)		$\Delta V_{DSS}/\Delta T_J$		0.037		$\text{V}/^\circ\text{C}$
Drain-to-Source Leakage Current ($V_{DS} = 30\text{ V}$, $V_{GS} = 0\text{ V}$, $T_J = 25^\circ\text{C}$) ($V_{DS} = 24\text{ V}$, $V_{GS} = 0\text{ V}$, $T_J = 150^\circ\text{C}$)		I_{DSS}			1 25	μA
Gate-to-Source Forward Leakage ($V_{GS} = 20\text{ V}$)		I_{GSS}			100	nA
Gate-to-Source Reverse Leakage ($V_{GS} = -20\text{ V}$)		I_{GSS}			-100	nA
ON Characteristics						
Gate Threshold Voltage ($V_{DS} = V_{GS}$, $I_D = 250\ \mu\text{A}$)		$V_{GS(th)}$	1.0	2.0	3.0	V
Static Drain-to-Source On-Resistance (Note 4) ($V_{GS} = 10\text{ V}$, $I_D = 20\text{ A}$)		$R_{DS(on)}$		14	17	m Ω
Forward Transconductance ($V_{DS} = 10\text{ V}$, $I_D = 20\text{ A}$) (Note 4)		g_{FS}		26		S
Dynamic Characteristics						
Input Capacitance	$(V_{DS} = 25\text{ V}$, $V_{GS} = 0\text{ V}$, $f = 1.0\text{ MHz}$)	C_{iss}		800		pF
Output Capacitance		C_{oss}		380		pF
Reverse Transfer Capacitance		C_{rss}		133		pF
Total Gate Charge ($V_{GS} = 10\text{ V}$)	$(V_{DS} = 24\text{ V}$, $I_D = 20\text{ A}$, $V_{GS} = 5\text{ V}$) (Note 5)	Q_g		17		nC
Gate-to-Source Charge		Q_{gs}		3		nC
Gate-to-Drain ("Miller") Charge		Q_{gd}		10		nC
Resistive Switching Characteristics						
Turn-On Delay Time	$(V_{DS} = 15\text{ V}$, $I_D = 20\text{ A}$, $V_{GS} = 10\text{ V}$, $R_G = 3.3\ \Omega$) (Note 5)	$t_{d(on)}$		7.2		ns
Rise Time		t_{rise}		60		ns
Turn-Off Delay Time		$t_{d(off)}$		22.5		ns
Fall Time		t_{fall}		10		ns
Source-Drain Diode Characteristics						
Continuous Source Current (Body Diode)	Integral pn-diode in MOSFET	I_S			40	A
Pulse Source Current (Body Diode)		I_{SM}			170	A
Diode Forward On-Voltage	$(I_S = 40\text{ A}$, $V_{GS} = 0\text{ V}$)	V_{SD}			1.3	V
Reverse Recovery Time	$(I_F = 40\text{ A}$, $V_{GS} = 0\text{ V}$, $d_i/d_t = 100\text{ A}/\mu\text{s}$)	t_{rr}		55		ns
Reverse Recovery Charge		Q_{rr}		110		nC

Note 1: $T_J = +25^\circ\text{C}$ to 150°C

Note 2: Repetitive rating; pulse width limited by maximum junction temperature.

Note 3: $I_{SD} = 12.0\text{ A}$, $d_i/d_t \leq 100\text{ A}/\mu\text{s}$, $V_{DD} \leq BV_{DSS}$, $T_J = +150^\circ\text{C}$

Note 4: Pulse width $\leq 250\ \mu\text{s}$; duty cycle $\leq 2\%$

Note 5: Essentially independent of operating temperature.

TYPICAL ELECTRICAL CHARACTERISTICS

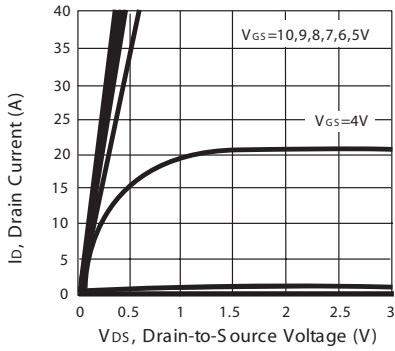

Figure 1. Output Characteristics

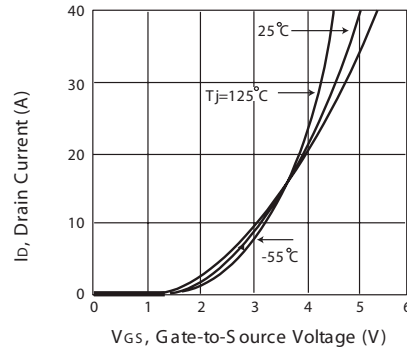

Figure 2. Transfer Characteristics

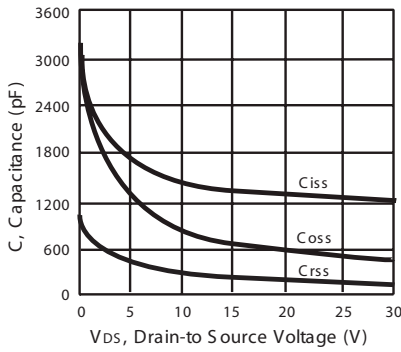

Figure 3. Capacitance

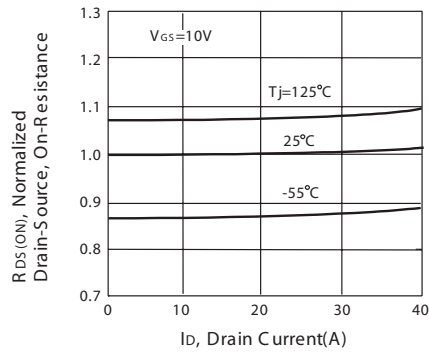

Figure 4. On-Resistance Variation with Drain Current and Temperature

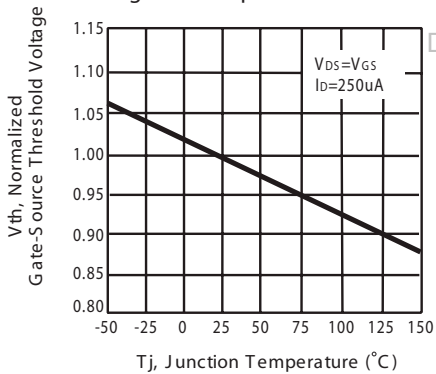

Figure 5. Gate Threshold Variation with Temperature

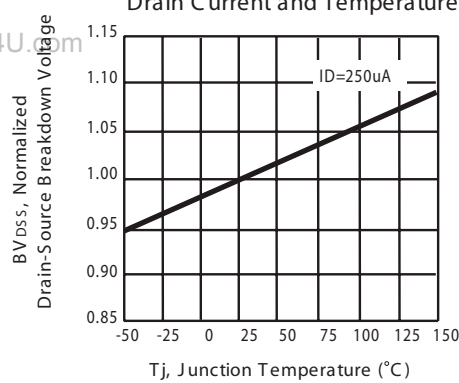

Figure 6. Breakdown Voltage Variation with Temperature

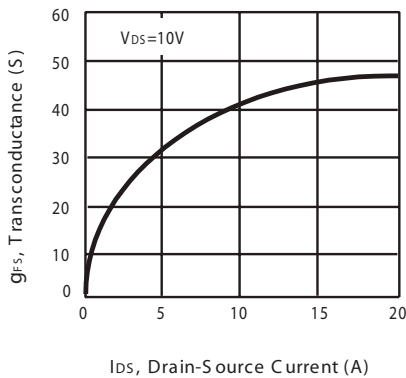

Figure 7. Transconductance Variation with Drain Current

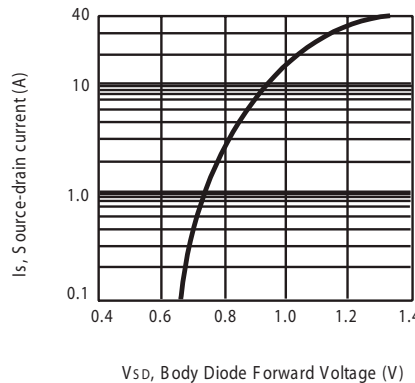

Figure 8. Body Diode Forward Voltage Variation with Source Current

et4U.com

DataSheet4U.com

DataShee

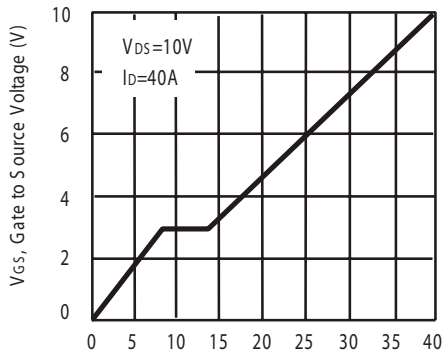

Figure 9. Gate Charge

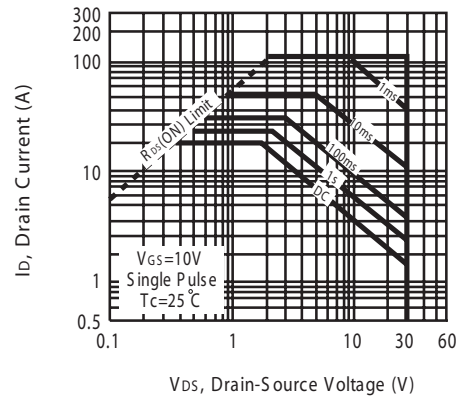

Figure 10. Maximum Safe Operating Area

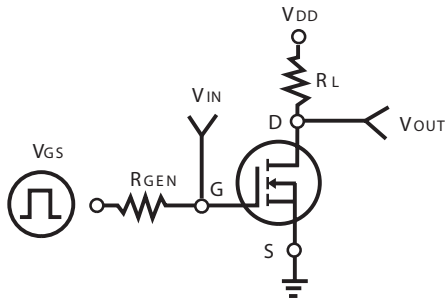

Figure 11. Switching Test Circuit

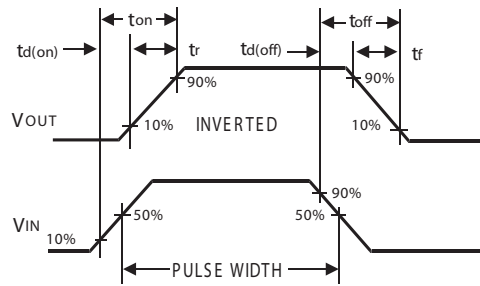

Figure 12. Switching Waveforms

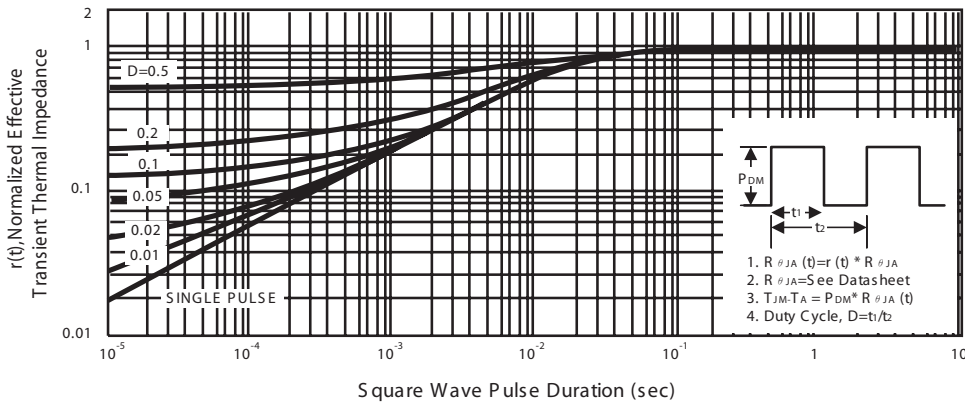

Figure 13. Normalized Thermal Transient Impedance Curve

WWW.ALLDATASHEET.COM

Copyright © Each Manufacturing Company.

All Datasheets cannot be modified without permission.

This datasheet has been download from :

www.AllDataSheet.com

100% Free DataSheet Search Site.

Free Download.

No Register.

DataSheet4U.com

Fast Search System.

www.AllDataSheet.com

et4U.com