

# PFC Boost Inductor

## EPC3245-XX



- Used as Power Factor Correction (PFC) Boost Inductor
- Isolation Between Shield and Winding : 4.5K Vrms
- All parts have Faraday Shield (except Toroid)
- Isolation Between Winding : 1500 Vrms
- UL 94V-0 Recognized Components
- UL 1446 Class B Insulation System
- \* Up to 100% Maximum Duty Cycle
- Very Large Gap Ferrite

### Electrical Specifications @ 25°C

Part Number	Inductance (µH ± 10%) @ 100 KHz, 0.1 Vrms	Max. Power (Watts)	Avg. Inductor Current (Amp.)	Peak Inductor Current (Amp.)	Switching Frequency (KHz Min.)	Vt (Volt µSec. Max.)	Core Shape	Package Drawing	Package Type	Schematic
EPC3245-1	2000	70	0.58	1.16	200	1900	EE	A	Horizontal	1
EPC3245-2	2000	70	0.58	1.16	200	1900	EE	B	Vertical	2
EPC3245-3	2000	190	1.58	3.16	100	3800	EE	C	Horizontal	3
EPC3245-4	2000	190	1.58	3.16	100	3800	EE	D	Vertical	4
EPC3245-5	1000	190	1.58	3.16	200	1900	Toroid	E	Horizontal	5
EPC3245-6	2000	190	1.58	3.16	100	3800	Toroid	E	Horizontal	5
EPC3245-7	1000	190	1.58	3.16	200	1900	Toroid	F	Vertical	5
EPC3245-8	2000	190	1.58	3.16	100	3800	Toroid	F	Vertical	5
EPC3245-9	500	310	2.58	5.15	100	3800	EE	G	Horizontal	6
EPC3245-10	1000	310	2.58	5.15	100	3800	EE	G	Horizontal	6
EPC3245-11	500	310	2.58	5.15	100	3800	ER	H	Vertical	3
EPC3245-12	1000	310	2.58	5.15	100	3800	ER	H	Vertical	3
EPC3245-13	500	430	3.58	7.15	100	3800	ER	I	Vertical	6
EPC3245-14	1000	430	3.58	7.15	100	3800	ER	I	Vertical	6
EPC3245-15	1000	550	4.58	9.15	50	7600	ETD	J	Horizontal	7
EPC3245-16	500	550	4.58	9.15	100	3800	ETD	J	Horizontal	7
EPC3245-17	1000	550	4.58	9.15	50	7600	ETD	K	Vertical	7
EPC3245-18	500	550	4.58	9.15	100	3800	ETD	K	Vertical	7

### Simplified Active PFC Boost Circuit

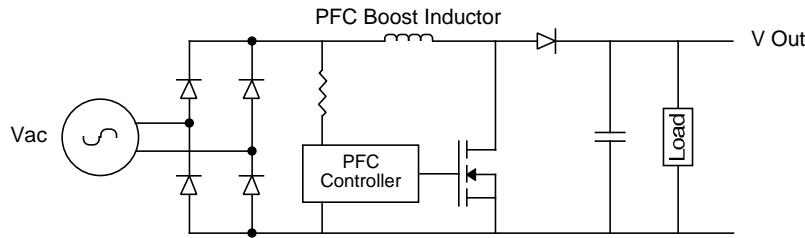

### Package A

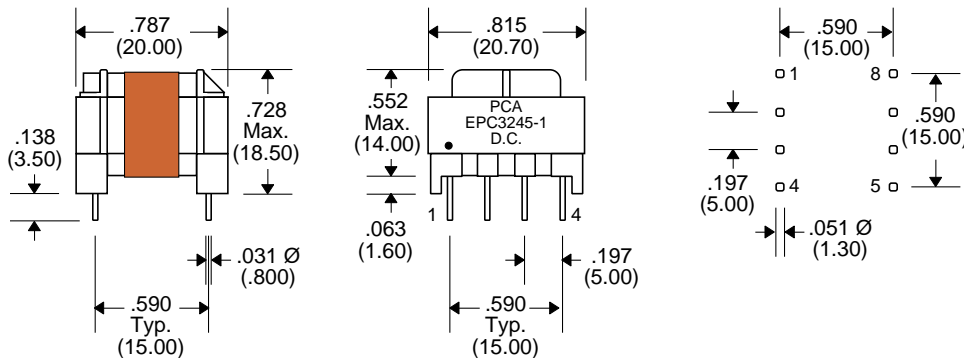

### Schematic 1

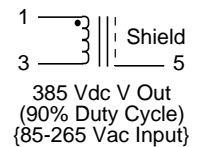

Unless Otherwise Specified Dimensions are in Inches /mm ± .010 / .25

# PFC Boost Inductor

## EPC3245-XX

### Package B

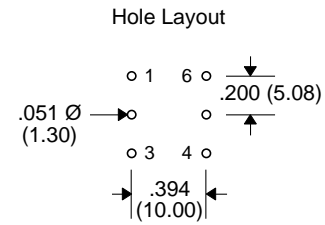
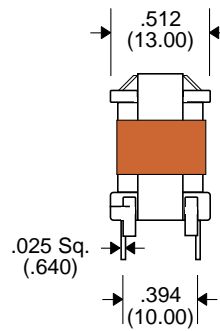
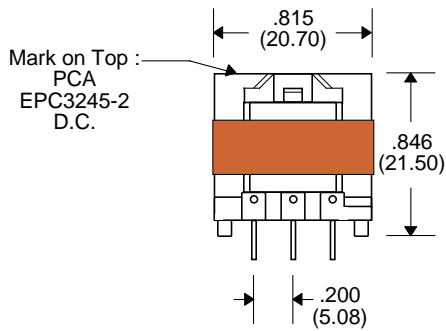

### Schematic 2

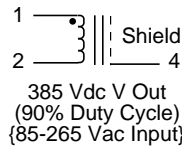

### Package C

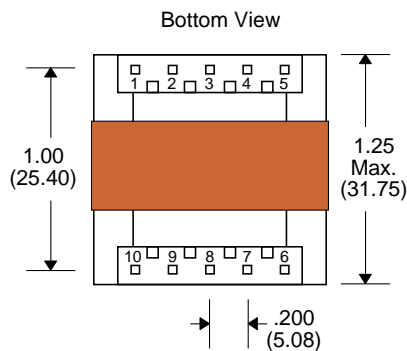
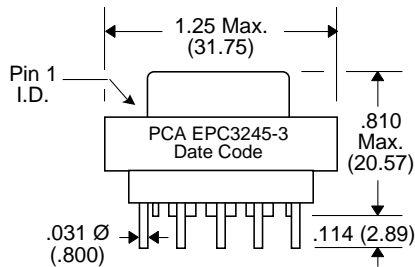

Leads : .025 Sq. (10 Places)

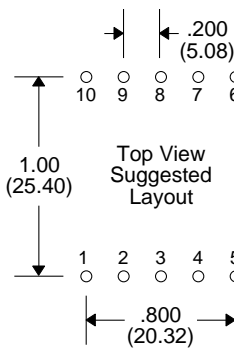

### Schematic 3

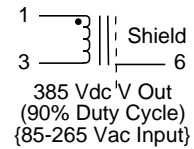

Unless Otherwise Specified Dimensions are in Inches /mm ± .010 / .25

# PFC Boost Inductor

## EPC3245-XX

### Package D

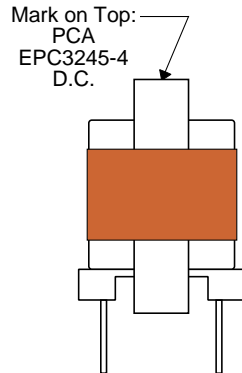
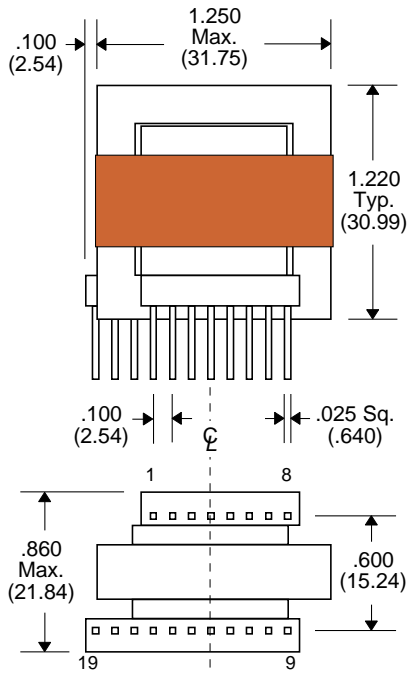

### Schematic 4

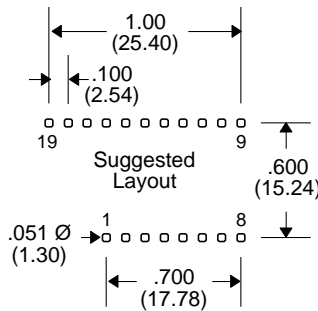
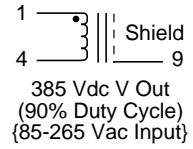

### Package E

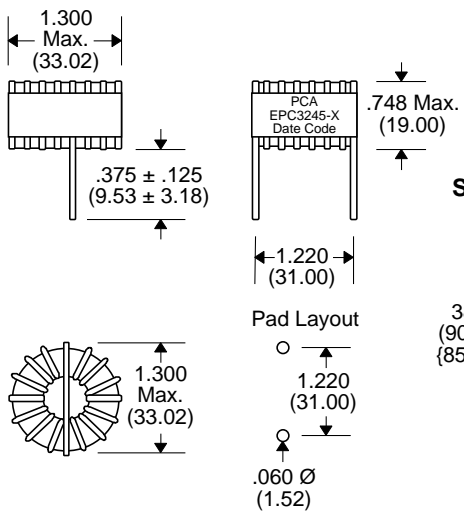

### Schematic 5

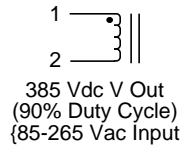

### Package F

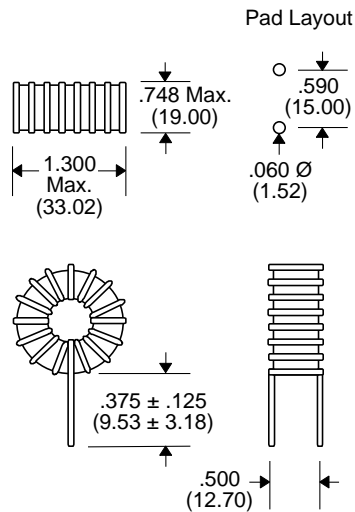

### Schematic 5

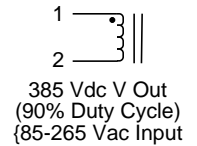

Unless Otherwise Specified Dimensions are in Inches /mm ± .010 / .25

# PFC Boost Inductor

## EPC3245-XX

**Package G**

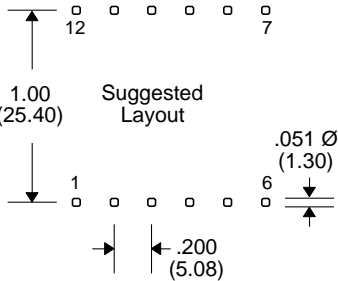
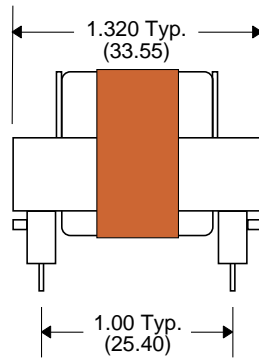
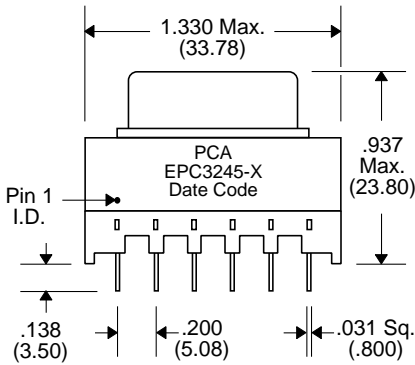

**Schematic 6**

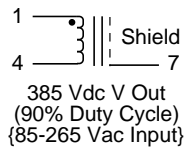

**Package H**

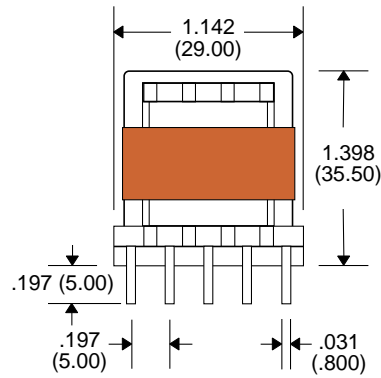

Mark on Top :  
 PCA  
 EPC3245-X  
 Date Code

**Schematic 3**

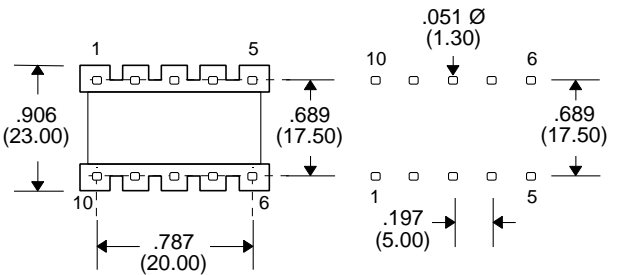
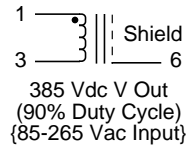

**Package I**

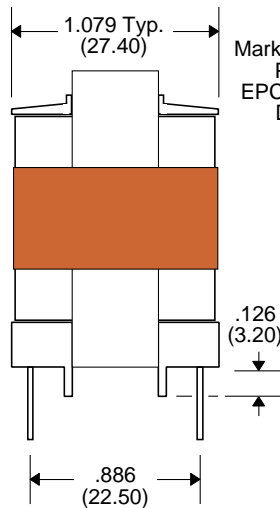
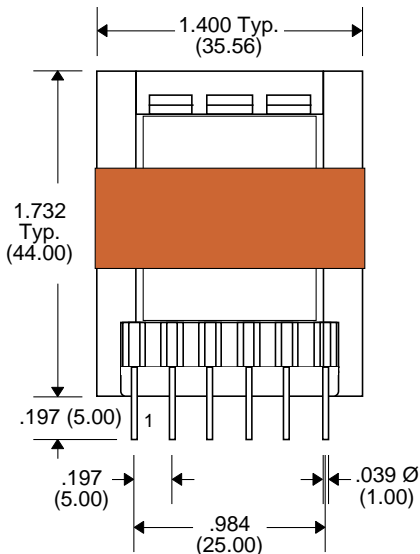

Mark on Top:  
 PCA  
 EPC3245-X  
 D.C.

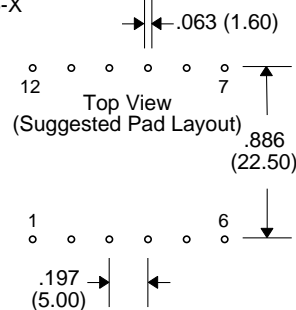

**Schematic 6**

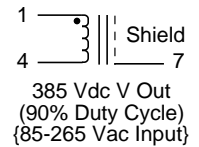

Unless Otherwise Specified Dimensions are in Inches /mm ± .010 /.25

# PFC Boost Inductor

## EPC3245-XX

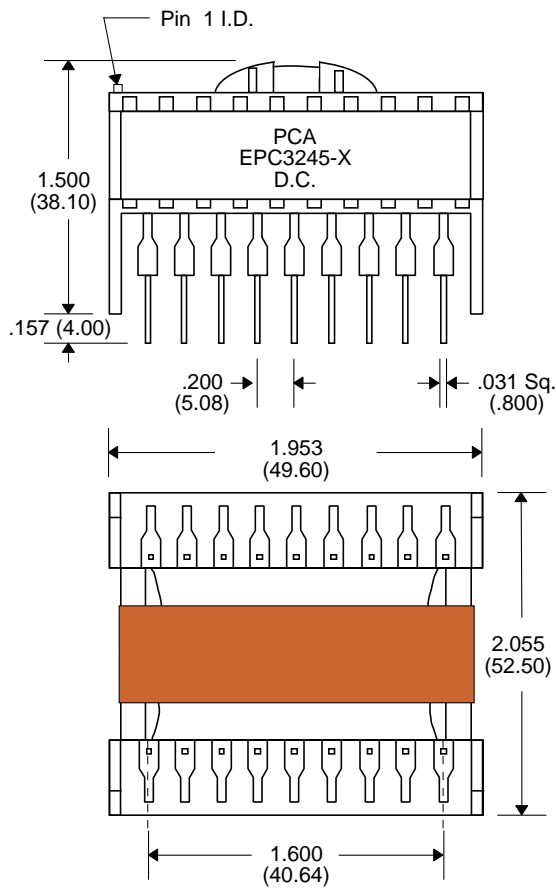

**Package J**

**Schematic 7**

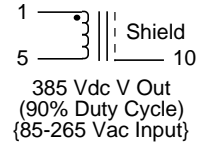

Mark on Top:  
PCA  
EPC3245-X  
D.C.

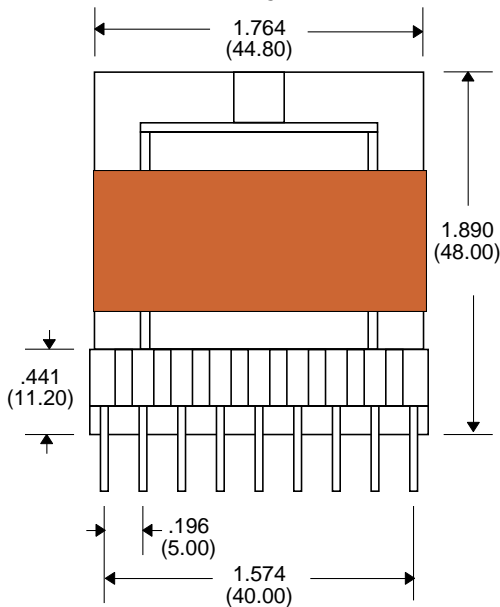

**Package K**

**Schematic 7**

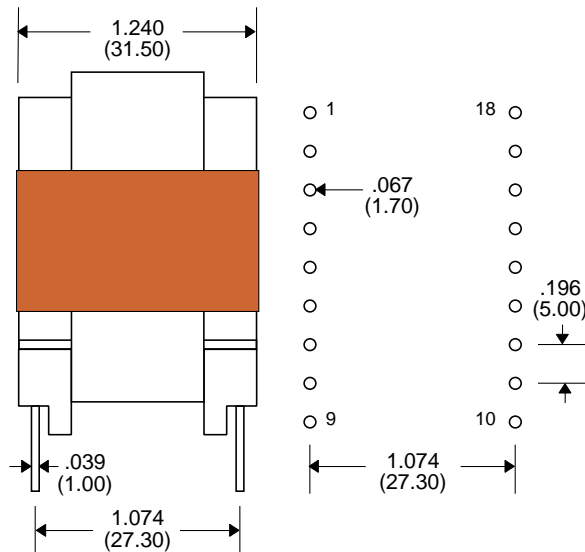

Unless Otherwise Specified Dimensions are in Inches /mm ± .010 /.25