

N-Channel Enhancement-Mode MOSFET

V_{DS} 30V R_{DS(ON)} 8mΩ I_D 70A



TRENCH GENFET®

TO-263AB

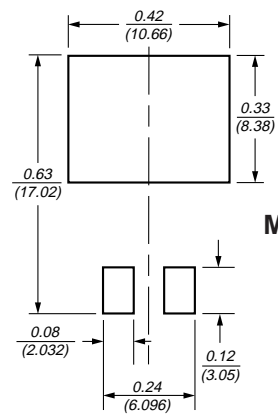
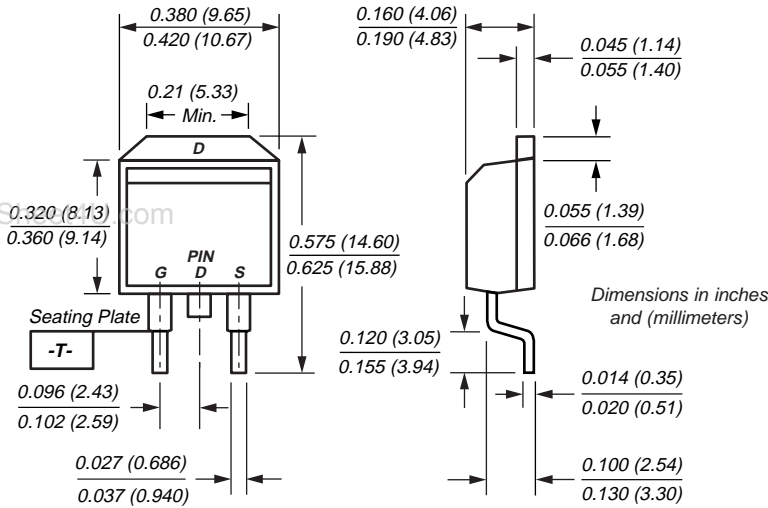
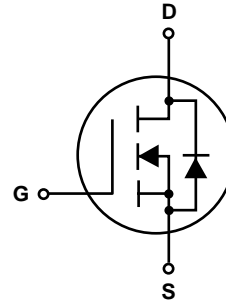

Mechanical Data

Case: JEDEC TO-263 molded plastic body
Terminals: Leads solderable per MIL-STD-750, Method 2026
High temperature soldering guaranteed: 250°C/10 seconds at terminals
Mounting Position: Any **Weight:** 1.3g

Features

- Advanced Trench Process Technology
- High Density Cell Design for Ultra Low On-Resistance
- Specially Designed for Low Voltage DC/DC Converters
- Fast Switching for High Efficiency

Maximum Ratings and Thermal Characteristics (T_C = 25°C unless otherwise noted)

Parameter	Symbol	Limit	Unit
Drain-Source Voltage	V _{DS}	30	V
Gate-Source Voltage	V _{GS}	±20	
Continuous Drain Current ⁽¹⁾	I _D	70	A
Pulsed Drain Current	I _{DM}	200	
Maximum Power Dissipation	P _D	T _C = 25°C 62.5	W
		T _C = 100°C 25	
Operating Junction and Storage Temperature Range	T _J , T _{stg}	-55 to 150	°C
Lead Temperature (1/8" from case for 5 sec.)	T _L	275	°C
Junction-to-Case Thermal Resistance	R _{θJC}	2.0	°C/W
Junction-to-Ambient Thermal Resistance ⁽²⁾	R _{θJA}	40	°C/W

Notes: (1) Maximum DC current limited by the package
(2) 1-in² 2oz. Cu PCB mounted

N-Channel Enhancement-Mode MOSFET

Electrical Characteristics (T_J = 25°C unless otherwise noted)

Parameter	Symbol	Test Condition	Min	Typ	Max	Unit
Static						
Drain-Source Breakdown Voltage	BV _{DSS}	V _{GS} = 0V, I _D = 250μA	30	—	—	V
Gate Threshold Voltage	V _{GS(th)}	V _{DS} = V _{GS} , I _D = 250μA	1.0	—	3.0	V
Gate-Body Leakage	I _{GSS}	V _{DS} = 0V, V _{GS} = ±20V	—	—	±100	nA
Zero Gate Voltage Drain Current	I _{DSS}	V _{DS} = 30V, V _{GS} = 0V	—	—	1	μA
On-State Drain Current ⁽¹⁾	I _{D(on)}	V _{DS} ≥ 5V, V _{GS} = 10V	70	—	—	A
Drain-Source On-State Resistance ⁽¹⁾	R _{DS(on)}	V _{GS} = 10V, I _D = 35A	—	6	8	mΩ
		V _{GS} = 4.5V, I _D = 30A	—	9	11	
Forward Transconductance ⁽¹⁾	g _{fs}	V _{DS} = 15V, I _D = 35A	—	61	—	S
Dynamic						
Total Gate Charge	Q _g	V _{DS} =15V, V _{GS} =5V, I _D =35A	—	34	48	nC
		V _{DS} = 15V, V _{GS} = 10V I _D = 35A	—	63	95	
Gate-Source Charge	Q _{gs}	V _{DS} = 15V, V _{GS} = 10V I _D = 35A	—	11	—	nC
Gate-Drain Charge	Q _{gd}		—	11	—	
Turn-On Delay Time	t _{d(on)}	V _{DD} = 15V, R _L = 15Ω I _D ≅ 1A, V _{GEN} = 10V R _G = 6Ω	—	9	14	ns
Rise Time	t _r		—	9	14	
Turn-Off Delay Time	t _{d(off)}		—	100	167	
Fall Time	t _f		—	31	62	
Input Capacitance	C _{iss}	V _{GS} = 0V	—	3400	—	pF
Output Capacitance	C _{oss}	V _{DS} = 15V	—	618	—	
Reverse Transfer Capacitance	C _{rss}	f = 1.0MHz	—	300	—	
Source-Drain Diode						
Max Diode Forward Current	I _S	—	—	—	35	A
Diode Forward Voltage ⁽¹⁾	V _{SD}	I _S = 35A, V _{GS} = 0V	—	0.9	1.3	V

Note: (1) Pulse test; pulse width ≤ 300 μs, duty cycle ≤ 2%

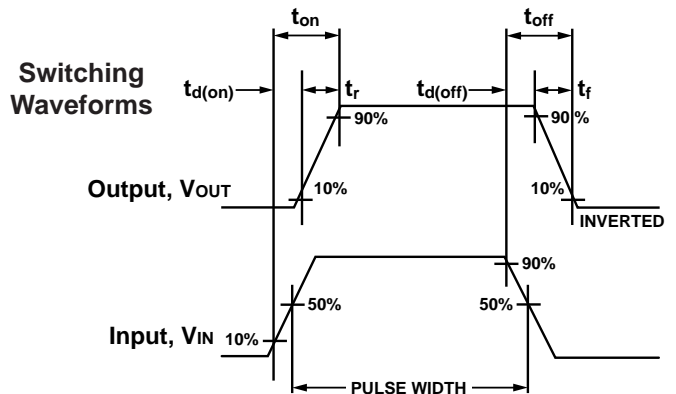
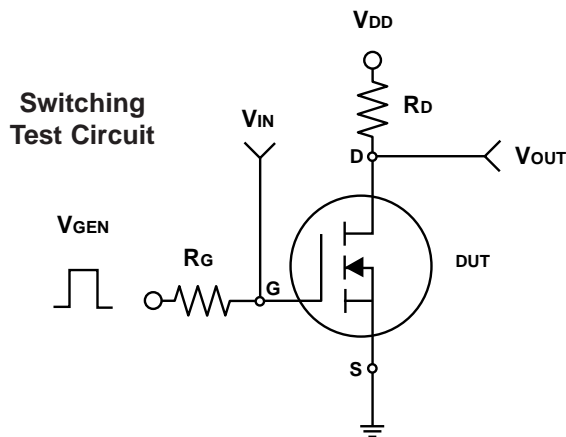

N-Channel Enhancement-Mode MOSFET

Ratings and Characteristic Curves (T_A = 25°C unless otherwise noted)

Fig. 1 – Output Characteristics

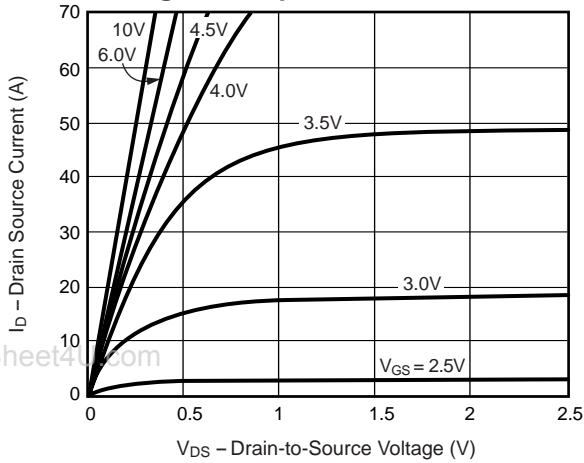

Fig. 2 – Transfer Characteristics

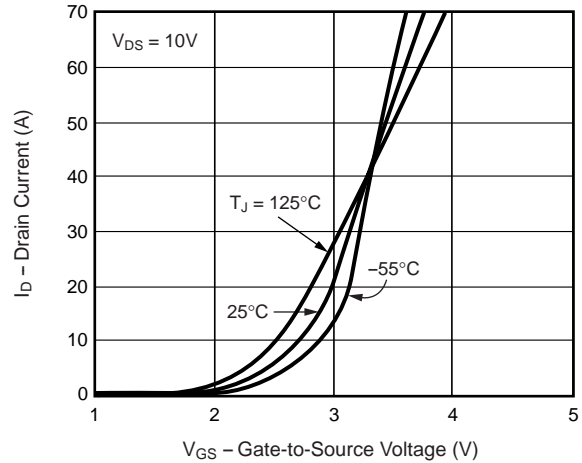

Fig. 3 – Threshold Voltage vs. Temperature

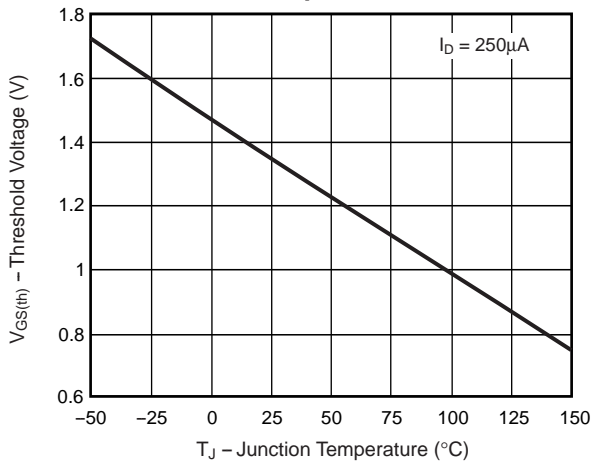

Fig. 4 – On-Resistance vs. Drain Current

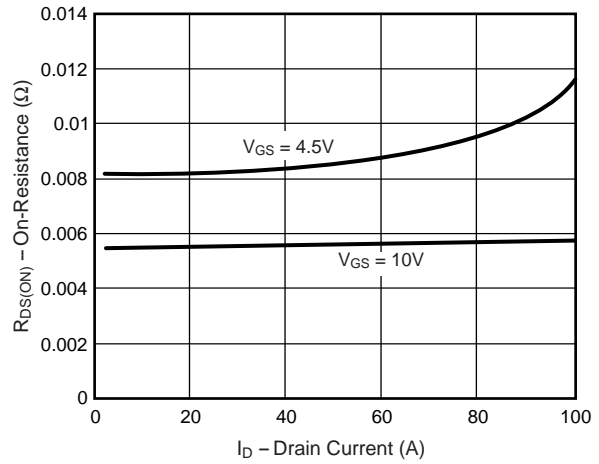
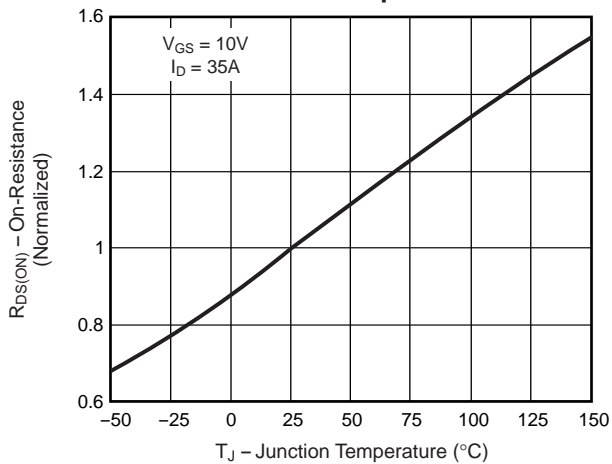

Fig. 5 – On-Resistance vs. Junction Temperature



N-Channel Enhancement-Mode MOSFET

Ratings and Characteristic Curves (T_A = 25°C unless otherwise noted)

Fig. 6 – On-Resistance vs. Gate-to-Source Voltage

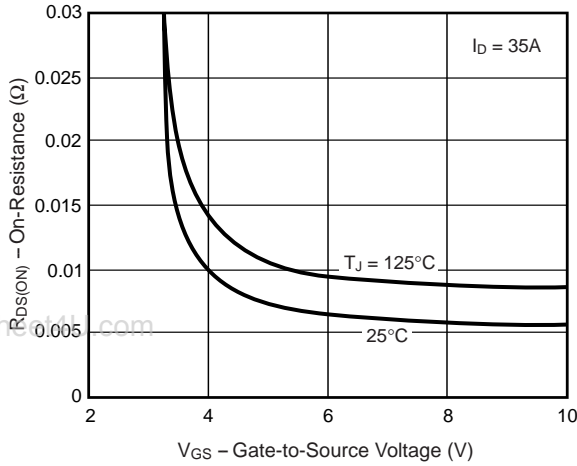

Fig. 7 – Gate Charge

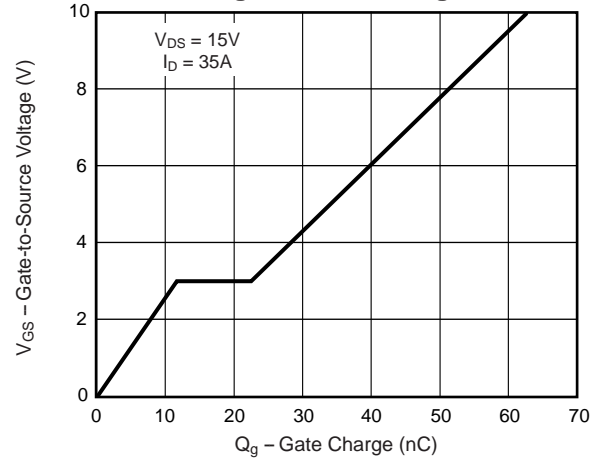

Fig. 8 – Capacitance

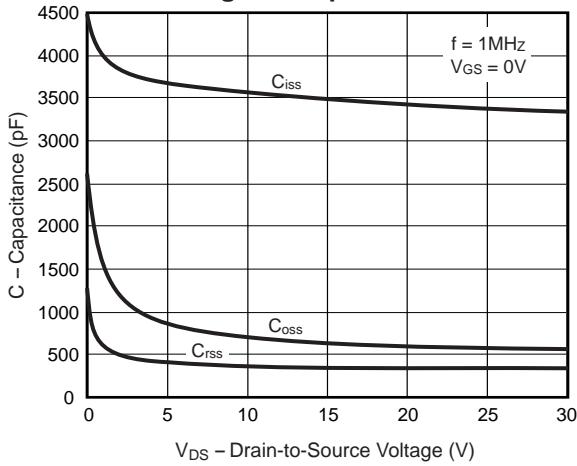
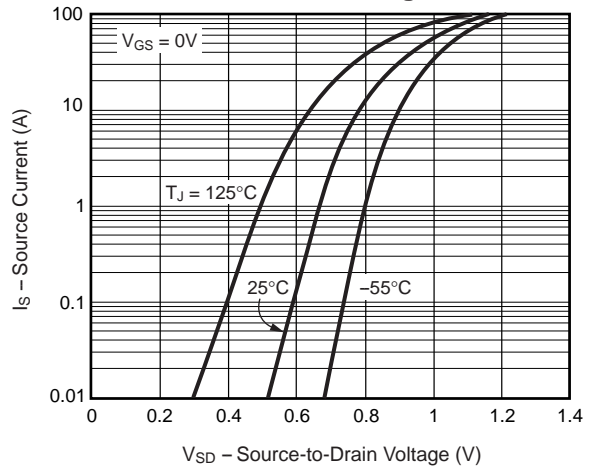

Fig. 9 – Source-Drain Diode Forward Voltage



N-Channel Enhancement-Mode MOSFET

Ratings and Characteristic Curves (T_A = 25°C unless otherwise noted)

Fig. 10 – Breakdown Voltage vs. Junction Temperature

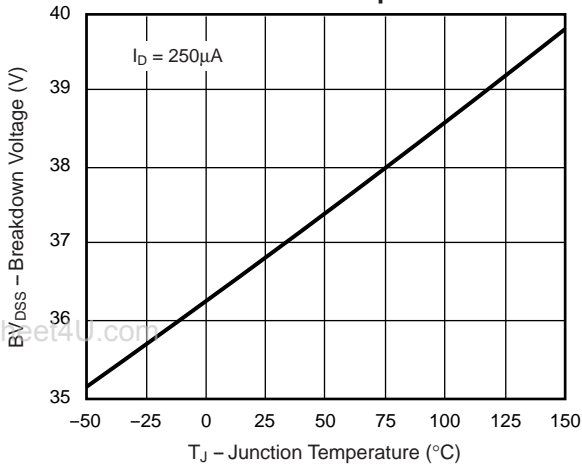

Fig. 11 – Thermal Impedance

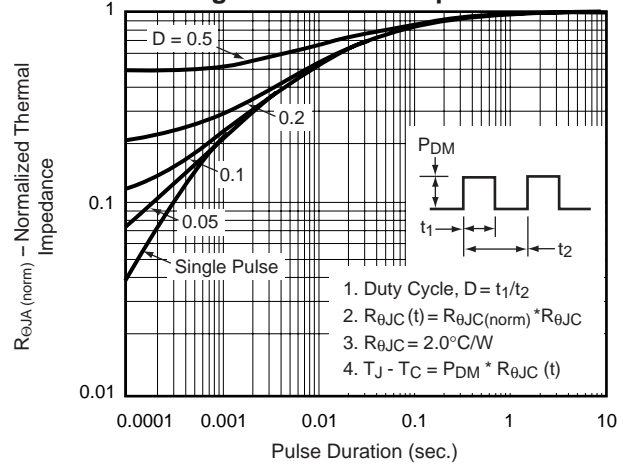

Fig. 12 – Power vs. Pulse Duration

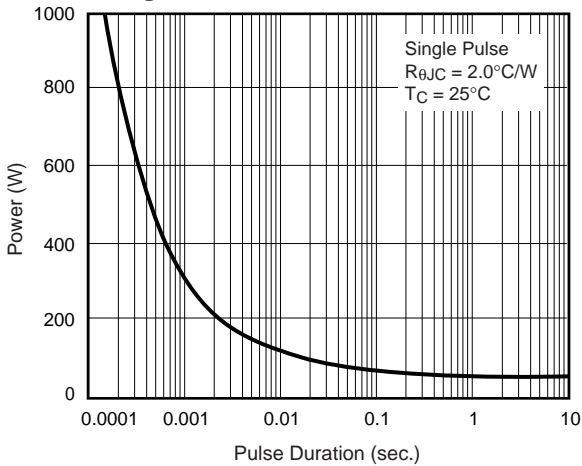

Fig. 13 – Maximum Safe Operating Area

