

# Transient Voltage Suppressors for ESD Protection

## General Description

The LESD5Z7.0T1G is designed to protect voltage sensitive components from ESD and transient voltage events. Excellent clamping capability, low leakage, and fast response time, make these parts ideal for ESD protection on designs where board space is at a premium.

## Applications

- Cellular phones
- Portable devices
- Digital cameras
- Power supplies

**LESD5Z7.0T1G**



**SC-79/SOD-523**

## Features

- Small Body Outline Dimensions
- Low Body Height
- Stand-off Voltage: 2.5 V – 7.0 V
- Peak Power up to 200 Watts @ 8 x 20\_ s Pulse
- Low Leakage
- Response Time is Typically < 1 ns
- ESD Rating of Class 3 (> 16 kV) per Human Body Model
- IEC61000-4-2 Level 4 ESD Protection
- IEC61000-4-4 Level 4 EFT Protection
- We declare that the material of product compliance with RoHS requirements.

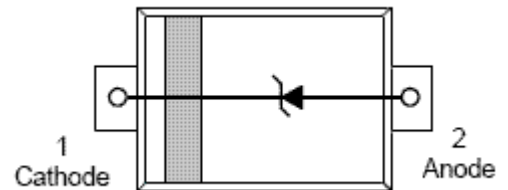

## ORDERING INFORMATION

Device	Package	Shipping
LESD5Z7.0T1G	SOD-523	3000/Tape & Reel

## Absolute Ratings (T<sub>amb</sub>=25°C)

Symbol	Parameter	Value	Units
P <sub>PP</sub>	Peak Pulse Power (t <sub>p</sub> = 8/20μs)	200	W
T <sub>L</sub>	Maximum lead temperature for soldering during 10s	260	°C
T <sub>stg</sub>	Storage Temperature Range	-55 to +150	°C
T <sub>op</sub>	Operating Temperature Range	-40 to +125	°C
T <sub>j</sub>	Maximum junction temperature	150	°C
	IEC61000-4-2 (ESD)	air discharge ± 15 contact discharge ± 8	KV
	IEC61000-4-4 (EFT)	40	A
	ESD Voltage	Per Human Body Model	16 KV

# LESD5Z7.0T1G

## Electrical Parameter

Symbol	Parameter
$I_{PP}$	Maximum Reverse Peak Pulse Current
$V_C$	Clamping Voltage @ $I_{PP}$
$V_{RWM}$	Working Peak Reverse Voltage
$I_R$	Maximum Reverse Leakage Current @ $V_{RWM}$
$I_T$	Test Current
$V_{BR}$	Breakdown Voltage @ $I_T$
$I_F$	Forward Current
$V_F$	Forward Voltage @ $I_F$

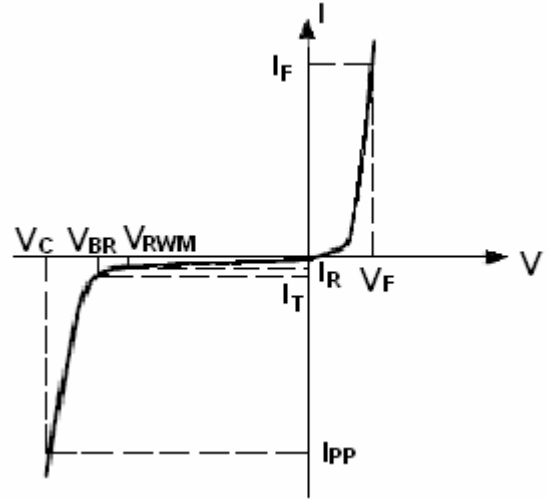

## Electrical Characteristics

Ratings at 25°C ambient temperature unless otherwise specified.  $V_F = 0.9V$  at  $I_F = 10mA$

Device	$V_{RWM}$ (V)	$I_R$ ( $\mu A$ ) @ $V_{RWM}$	$V_{BR}$ (V) @ $I_T$ (Note 1)	$I_T$	$V_C$ (V) @ $I_{PP}=5 A^*$	$V_C$ (V) @ Max $I_{PP}^*$	$I_{PP}$ (A)*	$P_{PK}$ (W)*	C (pF)
	Max	Max	Min	mA	Typ	Max	Max	Max	Typ
LESD5Z2.5T1G	2.5	6.0	4.0	1.0	6.5	10.9	11.0	120	145
LESD5Z3.3T1G	3.3	1.0	5.0	1.0	8.4	14.1	11.2	158	105
LESD5Z5.0T1G	5.0	1.0	6.2	1.0	11.6	18.6	9.4	174	80
LESD5Z6.0T1G	6.0	1.0	6.8	1.0	12.4	20.5	8.8	181	70
LESD5Z7.0T1G	7.0	1.0	7.5	1.0	13.5	22.7	8.8	200	65

\*Surge current waveform per Figure 1.

- $V_{BR}$  is measured with a pulse test current  $I_T$  at an ambient temperature of 25°C.

# LESD5Z7.0T1G

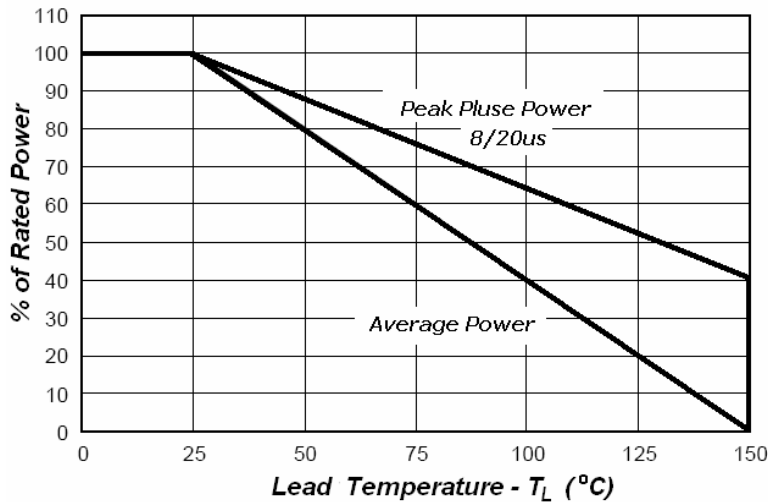
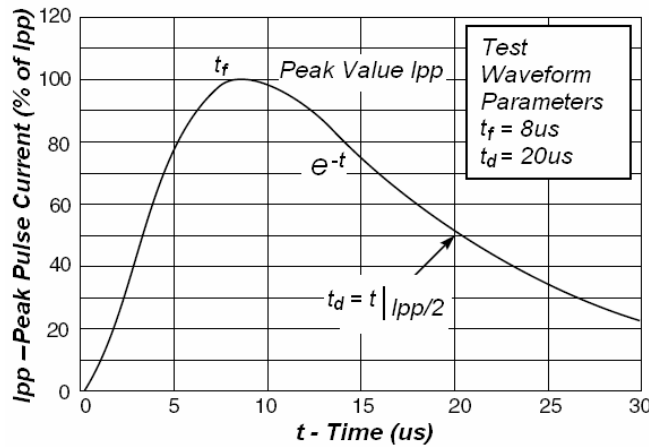

## Application Note

Electrostatic discharge (ESD) is a major cause of failure in electronic systems. Transient Voltage Suppressors (TVS) are an ideal choice for ESD protection. They are capable of clamping the incoming transient to a low enough level such that damage to the protected semiconductor is prevented.

Surface mount TVS offer the best choice for minimal lead inductance. They serve as parallel protection elements, connected between the signal line to ground. As the transient rises above the operating voltage of the device, the TVS becomes a low impedance path diverting the transient current to ground. The LESD5Z7.0T1G is the ideal board level protection of ESD sensitive semiconductor components.

The tiny SOD523 package allows design flexibility in the design of high density boards where the space saving is at a premium. This enables to shorten the routing and contributes to hardening against ESD.

# LESD5Z7.0T1G

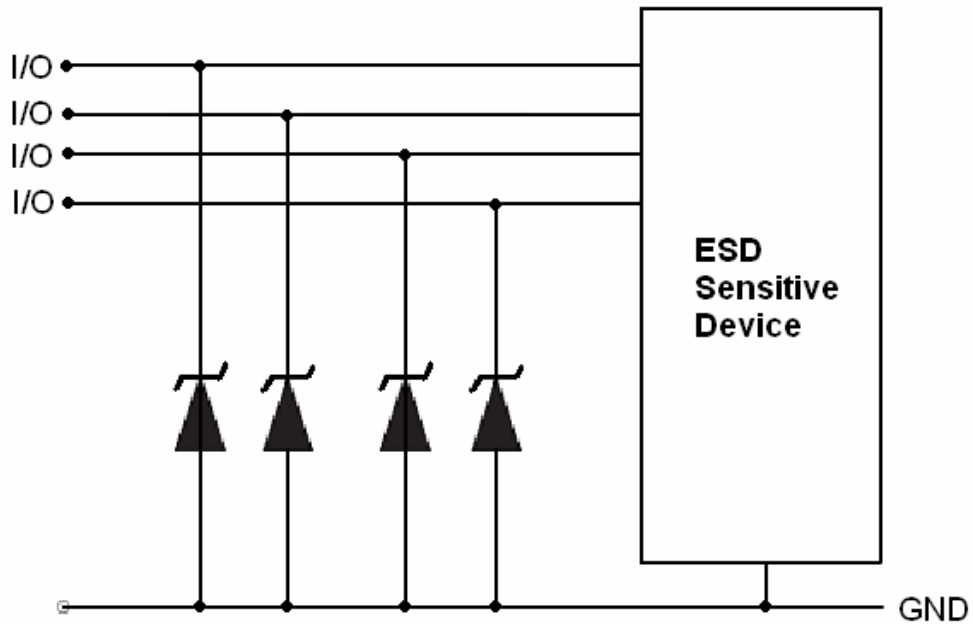

SC-79/SOD-523

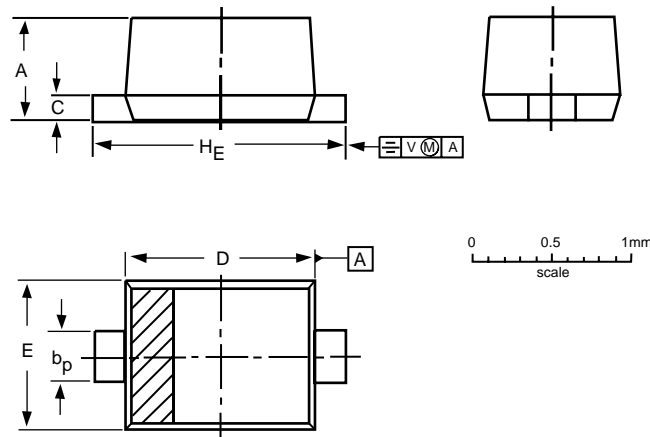

**DIMENSIONS (mm are the original dimensions)**

UNIT	A	b <sub>p</sub>	c	D	E	H <sub>E</sub>	V
mm	0.7	0.35	0.2	1.3	0.9	1.7	0.15
	0.5	0.25	0.1	1.1	0.7	1.5	

**Note**

1. The marking bar indicates the cathode.

OUTLINE VERSION	REFERENCES			EUROPEAN PROJECTION	ISSUE DATE
	IEC	JEDEC	EIAJ		
SOD523			SC-79		98-11-25

## EMBOSSED TAPE AND REEL DATA FOR DISCRETES

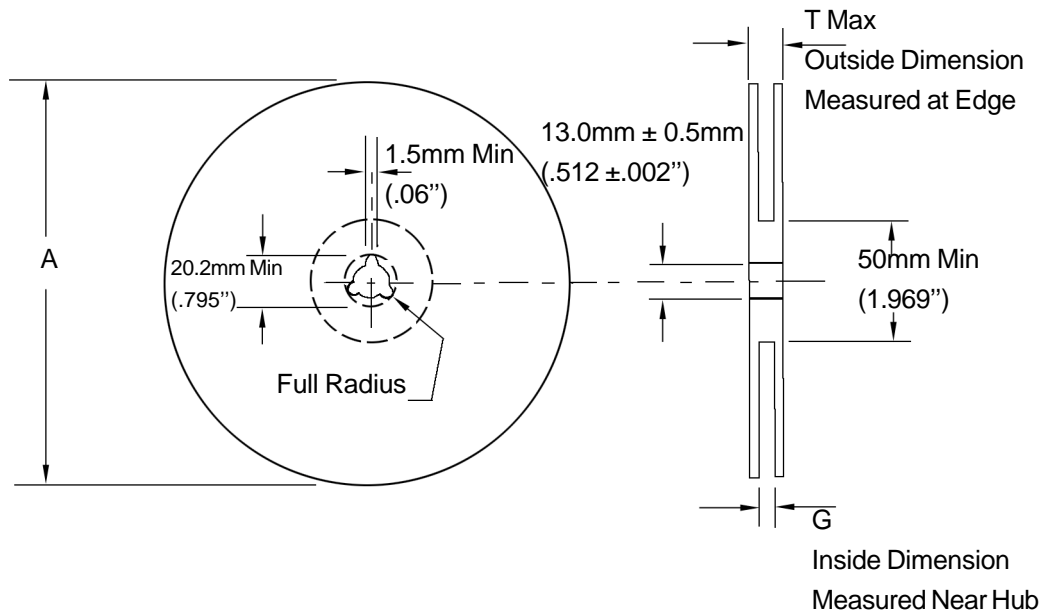

Size	A Max	G	T Max
8 mm	330mm (12.992")	8.4mm+1.5mm, -0.0 (.33"+.059", -0.00)	14.4mm (.56")

### Reel Dimensions

Metric Dimensions Govern — English are in parentheses for reference only

#### Storage Conditions

Temperature: 5 to 40 Deg.C (20 to 30 Deg. C is preferred)  
 Humidity: 30 to 80 RH (40 to 60 is preferred )  
 Recommended Period: One year after manufacturing  
 (This recommended period is for the soldering condition only. The characteristics and reliabilities of the products are not restricted to this limitation)

## Shipment Specification

