

The S-8473 Series is Wireless Power Receiver Control IC, which is configured with an overvoltage detection circuit, a charge current control circuit, a VBAT voltage detection circuit, a UVLO circuit, high temperature / low temperature detection circuit, etc. This IC has a charge function to a small lithium-ion rechargeable battery.

## ■ Features

- Power supply voltage:  $V_{DD} = 2.2\text{ V to }5.0\text{ V}$
- Current consumption during charge operation:  $I_{SS1} = 250\ \mu\text{A typ.}$
- VBAT pin current consumption during power-down:  $I_{PDN} = 1.0\ \mu\text{A max.}$
- UVLO detection voltage:  $V_{UVLO-} = 2.0\text{ V typ.}$
- Charge function to a small lithium-ion rechargeable battery
  - Charge current:  $I_{LIM} = 33\text{ mA typ.}$
  - Precharge current:  $I_{PRE} = 3.3\text{ mA typ.}$
  - Precharge completion voltage:  $2.4\text{ V to }3.4\text{ V (50 mV step)}$
  - Charge completion voltage:  $4.0\text{ V to }4.5\text{ V (50 mV step)}$
  - Recharge start voltage:  $3.6\text{ V to }4.45\text{ V}^*1$
  - Short-circuit detection voltage:  $1.5\text{ V to }2.0\text{ V (50 mV step)}$
  - Charge timer function: The charge operation stops after the elapse of 4.0 hours. ( $C_{CT} = 4.7\text{ nF}$ )  
The time is settable by connecting an external capacitor to the CT pin.
- High temperature / low temperature protection function: Available by connecting a thermistor to the TH pin.
- Status display function: Available by connecting an external LED to the STATUS pin.
  - During charge operation: Lighting
  - During charge operation stop: Lights-out
  - During error detection: Blinking
- Operation temperature range:  $T_a = -40^\circ\text{C to }+85^\circ\text{C}$
- Lead-free (Sn 100%), halogen-free

\*1. Recharge start voltage = charge completion voltage – charge hysteresis voltage  
(The charge hysteresis voltage can be selected from a range of 0.05 V to 0.40 V in 50 mV step.)

## ■ Applications

- Device for wireless power
- Small-sized wireless charge system

## ■ Package

- SNT-8A

■ Block Diagram

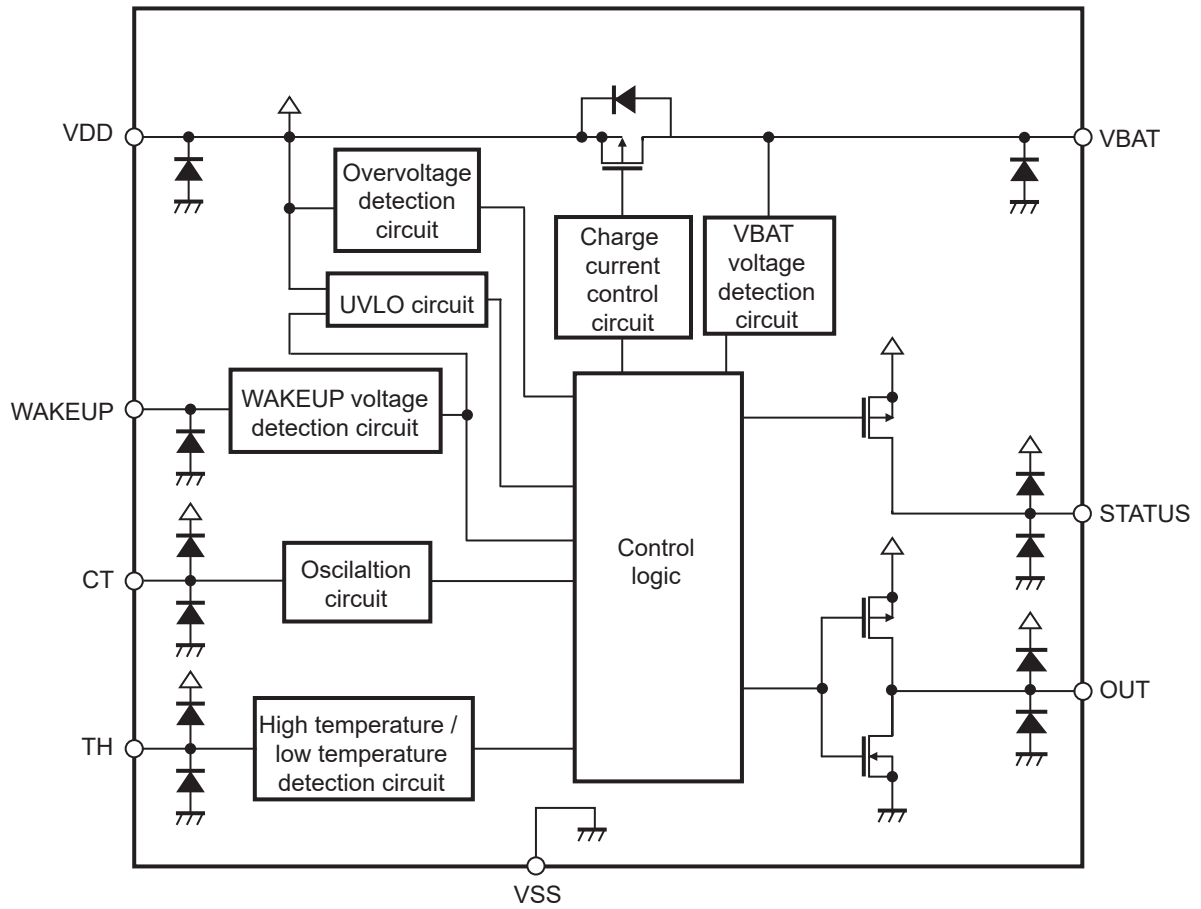

**Remark** All the diodes shown in the figure are parasitic diodes.

Figure 1

**■ Product Name Structure**

**1. Product name**

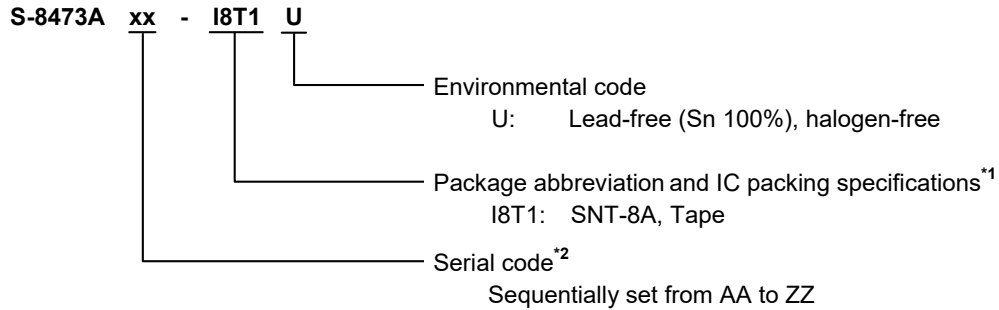

\*1. Refer to the tape drawing.

\*2. Refer to "3. Product name list".

**2. Package**

**Table 1 Package Drawing Codes**

Package Name	Dimension	Tape	Reel	Land
SNT-8A	PH008-A-P-SD	PH008-A-C-SD	PH008-A-R-SD	PH008-A-L-SD

**3. Product name list**

**Table 2**

Product Name	Charge Current [I <sub>LIM</sub> ]	Charge Completion Voltage [V <sub>END</sub> ]	Recharge Start Voltage [V <sub>RECHG</sub> ]	Precharge Completion Voltage [V <sub>PREH</sub> ]	Short-circuit Detection Voltage [V <sub>SHT</sub> ]
S-8473AAA-I8T1U	33 mA	4.2 V	4.0 V	3.0 V	2.0 V

**Remark** Please contact our sales representatives for products other than the above.

■ **Pin Configuration**

1. **SNT-8A**

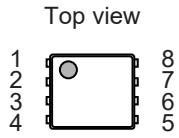

**Figure 2**

**Table 3**

Pin No.	Symbol	Description
1	VDD	Power supply voltage pin
2	VBAT	Connection pin of battery for charging
3	TH	Thermistor connection pin
4	STATUS	Output pin for status display
5	CT	Connection pin of capacitor for charge timer setting
6	WAKEUP	WAKEUP input pin
7	VSS	GND pin
8	OUT	FET gate drive pin for resonance

■ Absolute Maximum Ratings

Table 4

(Ta = +25°C unless otherwise specified)

Item	Symbol	Applied Pin	Absolute Maximum Rating	Unit
Input voltage between VDD pin and VSS pin	V <sub>DD</sub>	VDD	V <sub>SS</sub> - 0.3 to V <sub>SS</sub> + 7.0	V
Input voltage between VBAT pin and VSS pin	V <sub>VBAT</sub>	VBAT	V <sub>SS</sub> - 0.3 to V <sub>SS</sub> + 7.0	V
Input pin voltage	V <sub>IN</sub>	TH, CT, WAKEUP	V <sub>SS</sub> - 0.3 to V <sub>DD</sub> + 0.3	V
Output pin voltage	V <sub>OUT</sub>	STATUS, OUT	V <sub>SS</sub> - 0.3 to V <sub>DD</sub> + 0.3	V
Power dissipation	P <sub>D</sub>	-	450*1	mW
Operation ambient temperature	T <sub>opr</sub>	-	-40 to +85	°C
Storage temperature	T <sub>stg</sub>	-	-40 to +125	°C

\*1. When mounted on board

[Mounted board]

- (1) Board size: 114.3 mm × 76.2 mm × t1.6 mm
- (2) Board name: JEDEC STANDARD51-7

**Caution** The absolute maximum ratings are rated values exceeding which the product could suffer physical damage. These values must therefore not be exceeded under any conditions.

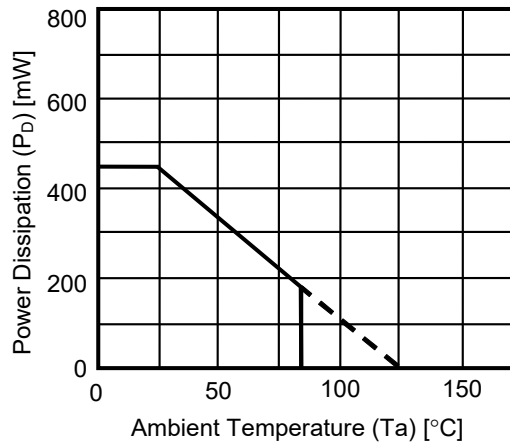

Figure 3 Power Dissipation of Package (When Mounted on Board)

■ **Electrical Characteristics**

**Table 5**

( $V_{DD} = V_{BAT} = 4.5\text{ V}$ ,  $T_a = +25^\circ\text{C}$  unless otherwise specified)

Item	Symbol	Condition	Min.	Typ.	Max.	Unit
Power supply voltage	$V_{DD}$	–	2.2	–	5.0	V
Current consumption during charge operation	$I_{SS1}$	$V_{DD} = V_{BAT} = V_{WAKEUP} = V_{END} - 0.1\text{ V}$	–	250	400	$\mu\text{A}$
VBAT pin current consumption during power-down	$I_{PDN}$	$V_{WAKEUP} = 0\text{ V}$ , VDD pin = open	–	0.1	1.0	$\mu\text{A}$
VDD pin current during charge operation completion	$I_{END1}$	$V_{WAKEUP} = V_{DD}$ , $V_{BAT} = V_{END} + 0.1\text{ V}$	–	150	300	$\mu\text{A}$
VBAT pin current during charge operation completion	$I_{END2}$	$V_{WAKEUP} = V_{DD}$ , $V_{BAT} = V_{END} + 0.1\text{ V}$	–	1.0	4.0	$\mu\text{A}$
UVLO detection voltage	$V_{UVLO-}$	–	1.9	2.0	2.1	V
UVLO release voltage	$V_{UVLO+}$	–	2.0	2.1	2.2	V
OUT pin sink current	$I_{OUTN}$	$V_{OUT} = 0.5\text{ V}$ , $V_{DD} = V_{END} + 0.4\text{ V}$	1.4	–	–	mA
OUT pin source current	$I_{OUTP}$	$V_{OUT} = V_{DD} - 0.5\text{ V}$ , $V_{DD} = V_{END} + 0.2\text{ V}$	–	–	-1.4	mA
WAKEUP pin input voltage "H"	$V_{SH}$	–	1.5	–	–	V
WAKEUP pin input voltage "L"	$V_{SL}$	–	–	–	0.4	V
WAKEUP pin input current "H"	$I_{SH}$	$V_{WAKEUP} = V_{DD}$	–	35	70	$\mu\text{A}$
WAKEUP pin input current "L"	$I_{SL}$	$V_{WAKEUP} = 0\text{ V}$	-0.1	–	0.1	$\mu\text{A}$
WAKEUP pin input disconnection delay time	$t_{WUL}$	–	40	85	130	ms
VBAT pin Pch driver on resistance	$R_{ONP}$	$V_{DD} = V_{END} - 0.1\text{ V}$	–	4.0	6.0	$\Omega$
VBAT pin Pch driver leakage current	$I_{LEAKP}$	$V_{WAKEUP} = 0\text{ V}$	–	–	1.0	$\mu\text{A}$
Charge current threshold	$I_{LIM}$	$V_{DD} = V_{END} - 0.1\text{ V}$	29	33	37	mA
Precharge current	$I_{PRE}$	$V_{DD} = V_{END} + 0.4\text{ V}$	2.9	3.3	3.7	mA
Precharge completion voltage	$V_{PREH}$	–	$V_{PREH} \times 0.99$	$V_{PREH}$	$V_{PREH} \times 1.01$	V
Charge completion voltage	$V_{END}$	–	$V_{END} \times 0.99$	$V_{END}$	$V_{END} \times 1.01$	V
Overvoltage detection voltage	$V_{OVP}$	$V_{OVP} = V_{END} + 0.3\text{ V}$	$V_{OVP} \times 0.98$	$V_{OVP}$	$V_{OVP} \times 1.02$	V
Overvoltage release voltage	$V_{OVPR}$	$V_{OVPR} = V_{END} + 0.2\text{ V}$	$V_{OVPR} \times 0.98$	$V_{OVPR}$	$V_{OVPR} \times 1.02$	V
Recharge start voltage	$V_{RECHG}$	–	$V_{RECHG} \times 0.99$	$V_{RECHG}$	$V_{RECHG} \times 1.01$	V
Short-circuit detection voltage	$V_{SHT}$	–	$V_{SHT} \times 0.98$	$V_{SHT}$	$V_{SHT} \times 1.02$	V
Short-circuit release voltage	$V_{SHTH}$	$V_{SHTH} = V_{SHT} + 0.1\text{ V}$	$V_{SHTH} \times 0.98$	$V_{SHTH}$	$V_{SHTH} \times 1.02$	V
STATUS pin Pch driver on resistance	$R_{ONPST}$	–	–	20	30	$\Omega$
STATUS pin leakage current	$I_{STPL}$	$V_{STATUS} = 0\text{ V}$ , $V_{BAT} = 0\text{ V}$	–	0.1	1.0	$\mu\text{A}$
TH pin internal resistance	$R_{LIN}$	–	72.79	80.88	88.97	k $\Omega$
TH pin high temperature protection detection voltage	$V_{TSDH}$	–	0.375	0.400	0.425	V
TH pin high temperature protection release voltage	$V_{TSRH}$	–	0.462	0.487	0.512	V
TH pin low temperature protection detection voltage	$V_{TSDL}$	–	0.950	0.975	1.000	V
TH pin low temperature protection release voltage	$V_{TSRL}$	–	0.900	0.925	0.950	V
Oscillation frequency for charge timer	$f_{OSC}$	$C_{CT} = 4.7\text{ nF}$	32.5	36.4	40.0	Hz
STATUS pin blinking cycle	$t_{SW}$	$C_{CT} = 4.7\text{ nF}$	0.79	0.88	0.97	s
STATUS pin blinking duty	$D_{SW}$	–	40	50	60	%

■ Test Circuit

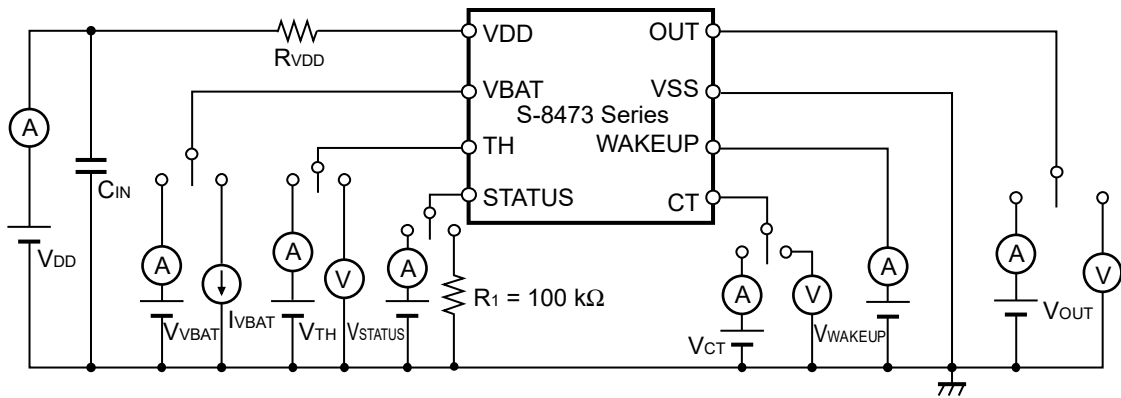

Figure 4

■ Operation

Remark Refer to "■ Standard Circuit".

1. Basic operation

1.1 Power reception

- (1) When the WAKEUP pin input voltage is the WAKEUP pin input voltage "H" ( $V_{SH}$ ) or higher and the power supply voltage ( $V_{DD}$ ) is the UVLO release voltage ( $V_{UVLO+}$ ) or higher, the operations of all internal circuits are started.  $V_{DD}$  ("H") is output from the OUT pin until  $V_{DD}$  reaches the overvoltage detection voltage ( $V_{OVP}$ ).
- (2) The charge operation to a lithium-ion rechargeable battery is started. Refer to "1.2 Charge operation" for details.
- (3) The WAKEUP pin input voltage is disconnected, and then  $V_{DD}$  decreases gradually.
- (4) When  $V_{DD}$  is the UVLO detection voltage ( $V_{UVLO-}$ ) or lower, the IC changes to a UVLO detection status. In the UVLO detection status, the operations of all internal circuits other than the UVLO circuit are stopped,  $V_{SS}$  ("L") is output from the OUT pin, and the STATUS pin changes to "High-Z".
- (5) The WAKEUP pin input voltage decreases to the WAKEUP pin input voltage "L" ( $V_{SL}$ ) or lower, after the elapse of the WAKEUP pin input disconnection delay time ( $t_{WUL}$ ), the IC changes to a power-down status. In the power-down status, the operations of all internal circuits are stopped, reducing the current consumption significantly.  $V_{SS}$  is output from the OUT pin and the STATUS pin changes to "High-Z".

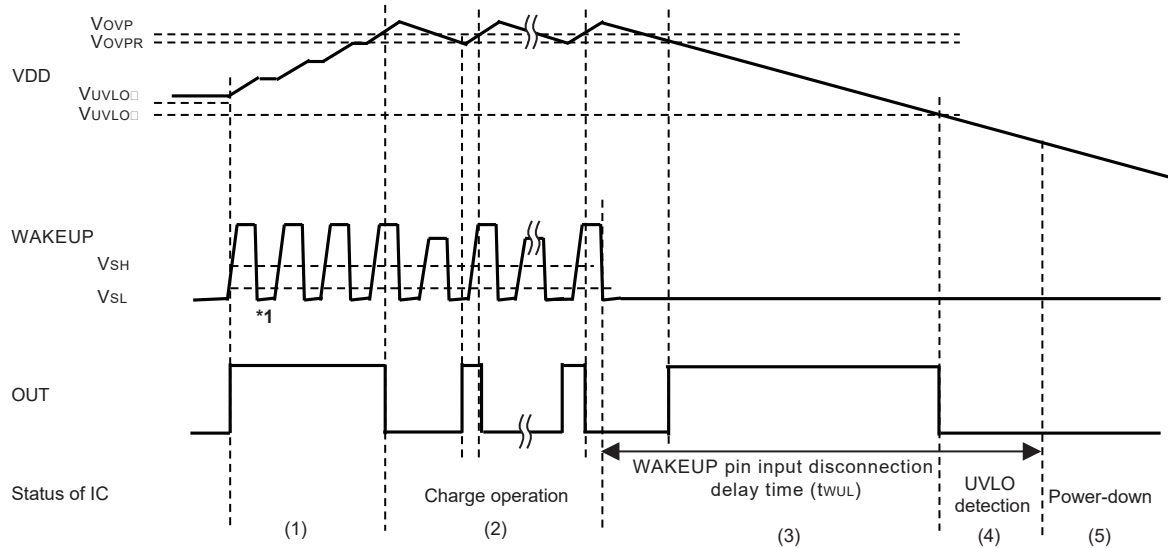

\*1. If the time that the WAKEUP pin input voltage decreases to  $V_{SL}$  or lower is under  $t_{WUL}$ , the IC continues the operation.

Figure 5

Remark Between  $V_{SL}$  and  $V_{SH}$  or  $V_{UVLO+}$  and  $V_{UVLO-}$ , there is a hysteresis width for avoiding malfunctions due to generation of noise etc. in the input voltage, respectively.



1.2 Charge operation

Power supply voltage ( $V_{DD}$ ) is output from the OUT pin until  $V_{DD}$  reaches  $V_{OVP}$ . When  $V_{DD}$  exceeds the VBAT pin voltage ( $V_{BAT}$ ) + 0.6 V typ., the charge operation is started.

(1) Precharge operation

When  $V_{BAT}$  is the short-circuit release voltage ( $V_{SHTH}$ ) or higher and lower than the precharge completion voltage ( $V_{PREH}$ ), the precharge operation is performed. The charge current during the precharge operation changes to the precharge current ( $I_{PRE}$ ). During the precharge operation,  $V_{SS}$  is output from the OUT pin when  $V_{DD}$  is  $V_{OVP}$  or higher, and  $V_{DD}$  is output from the OUT pin when  $V_{DD}$  is the overvoltage release voltage ( $V_{OVPR}$ ) or lower.

(2) Normal charge operation

When  $V_{BAT}$  is  $V_{PREH}$  or higher and lower than the charge completion voltage ( $V_{END}$ ), the normal charge operation is performed.

In the normal charge operation, a Pch driver connected between the VDD pin and the VBAT pin is turned on, and a current flows from the VDD pin to the VBAT pin.  $V_{SS}$  is output from the OUT pin when the charge current is the charge current threshold ( $I_{LIM}$ ) or higher, and  $V_{DD}$  is output from the OUT pin when the charge current is  $I_{LIM}$  or lower. When  $V_{BAT}$  is  $V_{END}$  or higher,  $I_{LIM}$  decreases and the IC continues the charge operation. Each time  $V_{BAT}$  reaches  $V_{END}$ ,  $I_{LIM}$  decreases in four steps of  $I_{LIM} \times 3/4$ ,  $I_{LIM} \times 1/2$ ,  $I_{LIM} \times 1/4$  and  $I_{PRE}$ .

(3) Charge operation completion

At the time when  $V_{BAT}$  reaches  $V_{END}$  after  $I_{LIM}$  changes to  $I_{PRE}$ , the charge operation is completed.

A Pch driver is turned off when the charge operation is completed,  $V_{SS}$  is output from the OUT pin when  $V_{DD}$  is  $V_{OVP}$  or higher, and  $V_{DD}$  is output from the OUT pin when  $V_{DD}$  is  $V_{OVPR}$  or lower.

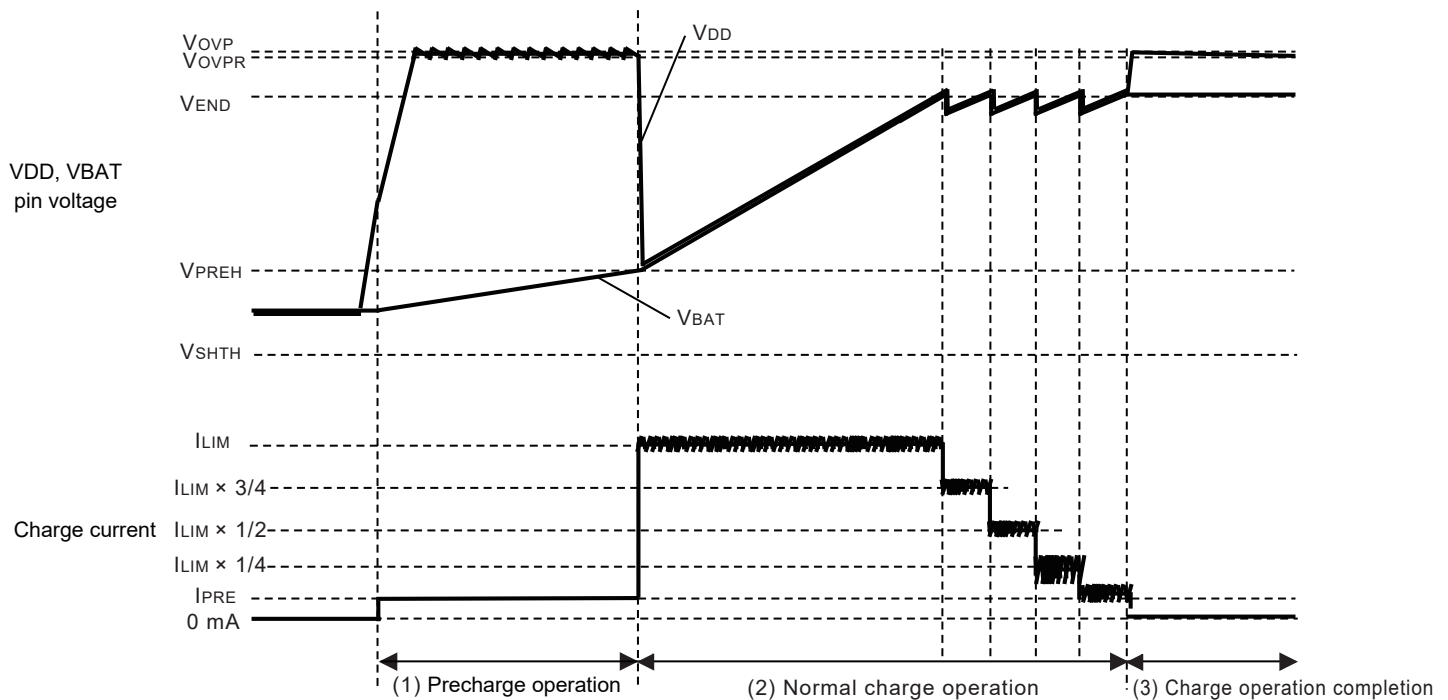

Figure 6

**Remark** When  $V_{BAT}$  decreases to the recharge start voltage ( $V_{RECHG}$ ) after the charge operation is completed, the charge operation is resumed.

1.3 Short-circuit detection

In the S-8473 Series, the charge operation is stopped when  $V_{BAT}$  decreases due to a battery abnormality, a short-circuit, etc. The charge operation is stopped when  $V_{BAT}$  is short-circuit detection voltage ( $V_{SHT}$ ) or lower, "H" and "High-Z" are output from the STATUS pin, and the operation is repeated with the STATUS pin blinking cycle ( $t_{sw}$ ). Also,  $V_{SS}$  is output from the OUT pin when  $V_{DD}$  is  $V_{OVP}$  or higher, and  $V_{DD}$  is output from the OUT pin when  $V_{DD}$  is  $V_{OVPR}$  or lower. When  $V_{BAT}$  increases to the short-circuit release voltage ( $V_{SHTH}$ ) or higher, the charge operation is started.

## 2. Charge timer function

In the S-8473 Series, a charge timer can be set by connecting an external capacitor to the CT pin. The precharge timer which sets the time from the charge operation start to the precharge operation completion and the charge completion timer which sets the time from the charge operation start to the charge operation completion are prepared. The charge operation is stopped due to a time-out of the charge timer, the IC changes to a charge time-out status, "H" and "High-Z" are output from the STATUS pin, and the operation is repeated with  $t_{sw}$ . Also,  $V_{SS}$  is output from the OUT pin when  $V_{DD}$  is  $V_{OVP}$  or higher, and  $V_{DD}$  is output from the OUT pin when  $V_{DD}$  is  $V_{OVPR}$  or lower.

By setting the IC power-down status or decreasing  $V_{DD}$  to  $V_{UVLO-}$  or lower, the charge time-out status can be reset. Depending on the oscillation frequency for charge timer ( $f_{OSC}$ ) which is determined by the capacitance of the CT pin, the precharge timer or the charge completion timer can be set by using the following equation.

$$\text{Precharge timer: } \frac{1}{f_{OSC} [\text{Hz}]} \times 2^{16} [\text{s}] \qquad \text{Charge completion timer: } \frac{1}{f_{OSC} [\text{Hz}]} \times 2^{19} [\text{s}]$$

For example, when  $C_{CT} = 4.7 \text{ nF}$ , settings of the precharge timer and the charge completion timer are approximately 30 minutes and approximately 4.0 hours, respectively.

$f_{OSC}$  is calculated by the following equation.

$$f_{OSC} [\text{Hz}] = \frac{170.77}{C_{CT} [\text{nF}]}$$

Select the external capacitor ( $C_{CT}$ ) in the range of 0.22 nF to 47 nF, and connect it between the CT pin and the VSS pin.

## 3. High temperature / low temperature protection function

By connecting an external thermistor to the TH pin, a temperature abnormal status can be prevented.

### 3.1 High temperature protection function

When the temperature of external components increases and the resistance of thermistor decreases to the resistance calculated by equation (1) ( $R_{TH}$ ), the status changes to a high temperature protection status. In the high temperature protection status, the charge operation is resumed when  $R_{TH}$  increases to the resistance calculated by equation (2).

$$(1) R_{TH} [\text{k}\Omega] = \frac{R_{LIN} [\text{k}\Omega] \times V_{TSDH} [\text{V}]}{(1.2 - V_{TSDH} [\text{V}])} \qquad (2) R_{TH} [\text{k}\Omega] = \frac{R_{LIN} [\text{k}\Omega] \times V_{TSRH} [\text{V}]}{(1.2 - V_{TSRH} [\text{V}])}$$

### 3.2 Low temperature protection function

When the temperature of external components decreases and the resistance of  $R_{TH}$  increases to the resistance calculated by equation (3), the status changes to a low temperature protection status. In the low temperature protection status, the charge operation is resumed when  $R_{TH}$  decreases to the resistance calculated by equation (4).

$$(3) R_{TH} [\text{k}\Omega] = \frac{R_{LIN} [\text{k}\Omega] \times V_{TSDL} [\text{V}]}{(1.2 - V_{TSDL} [\text{V}])} \qquad (4) R_{TH} [\text{k}\Omega] = \frac{R_{LIN} [\text{k}\Omega] \times V_{TSRL} [\text{V}]}{(1.2 - V_{TSRL} [\text{V}])}$$

In the high temperature / low temperature protection status, the charge function and the charge timer function are stopped, and the CT pin becomes  $V_{SS}$  potential. However, the internal other circuits operate during the period unlike the power-down status, so caution should be exercised.

Connect a thermistor between the TH pin and the VSS pin. An NTC thermistor of  $R = 100 \text{ k}\Omega$  ( $R_{25}$ ) at  $T_a = +25^\circ\text{C}$  is recommended. For example, if an NTC thermistor of  $R_{25}$  and  $B_{25/50}$  (B constant ( $25^\circ\text{C}/50^\circ\text{C}$ )) = 4250 K is used, the high temperature protection function begins to operate at approximately  $+45^\circ\text{C}$ , and the low temperature protection function begins to operate at approximately  $0^\circ\text{C}$ .

When not using the high temperature / low temperature protection function, connect a resistor of 100 k $\Omega$ .

**4. Status display function**

The S-8473 Series can display the operation status by connecting an external LED to the STATUS pin.

During the charge operation, a Pch driver of the STATUS pin is turned on, "H" is output from the STATUS pin, and the external LED is lighted on.

During the charge operation stop, the Pch driver of the STATUS pin is turned off, the STATUS pin changes to "High-Z", and the external LED is lighted off.

During the error detection, the Pch driver of the STATUS pin is turned on and off repeatedly. Also, "H" and "High-Z" are output from the STATUS pin, the operation is repeated with  $t_{sw}$ , and the external LED is blinked.

When not using the status display function, set the STATUS pin open.

**Table 6**

Status		STATUS Pin	External LED
During charge operation	Precharge operation	"H"	Lighting
	Normal charge operation		
During charge operation stop	Power-down status	"High-Z"	Lights-out
	Charge operation completion		
During error detection	Short-circuit detection	"H" ↔ "High-Z"	Blinking
	Charge time-out status		
High temperature / low temperature protection status		Maintaining*1	Maintaining*1

\*1. The status before the high temperature / low temperature protection function operates is maintained.

■ **Standard Circuit**

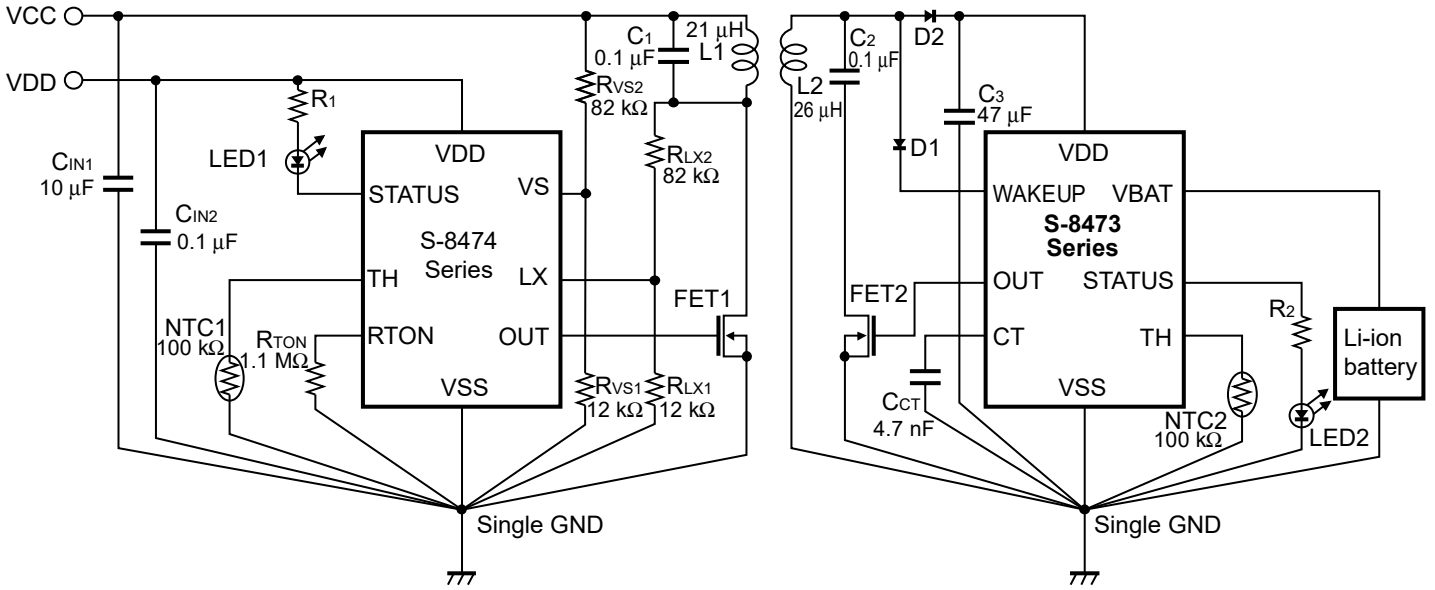

Figure 7

**Caution** The above connection diagram and constant will not guarantee successful operation.  
 Perform thorough evaluation using the actual application to set the constant.

**■ Precautions**

- Mount an external resistor, a capacitor, a diode, an FET, etc. as close as possible to the IC so as to make the single GND.
- When the wiring impedance is high, the operation may be unstable due to the resonance circuit or the noise caused by switching of the output pin, so perform thorough evaluation using the actual application when designing.
- The power dissipation of the IC greatly varies depending on the size and material of the board to be mounted. Perform thorough evaluation using the actual application when designing.
- Do not apply an electrostatic discharge to this IC that exceeds the performance ratings of the built-in electrostatic protection circuit.
- ABLIC Inc. claims no responsibility for any and all disputes arising out of or in connection with any infringement by products including this IC of patents owned by a third party.

■ Characteristics (Typical Data)

1. Current consumption

1.1 I<sub>SS1</sub> vs. Ta

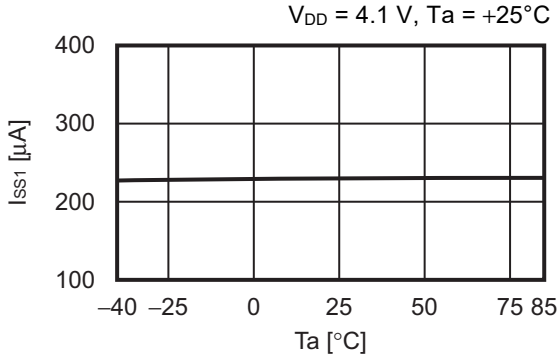

1.2 I<sub>PDN</sub> vs. Ta

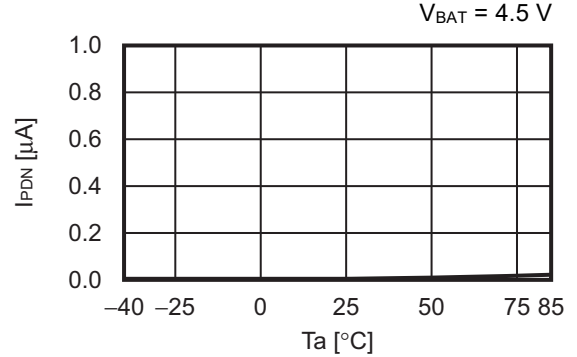

1.3 I<sub>END1</sub> vs. Ta

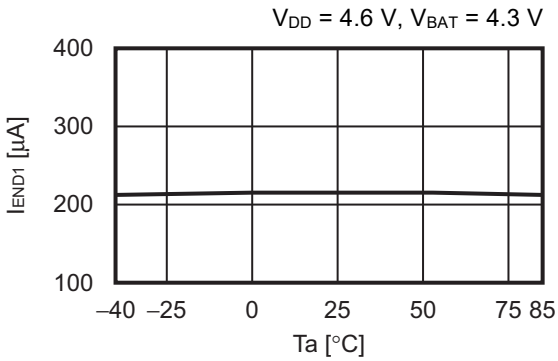

1.4 I<sub>END2</sub> vs. Ta

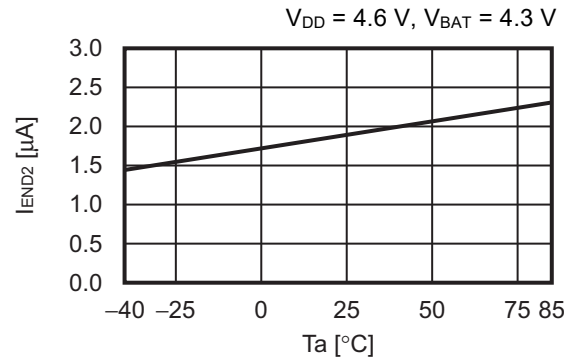

2. Precharge current, charge current threshold

2.1 I<sub>PRE</sub> vs. Ta

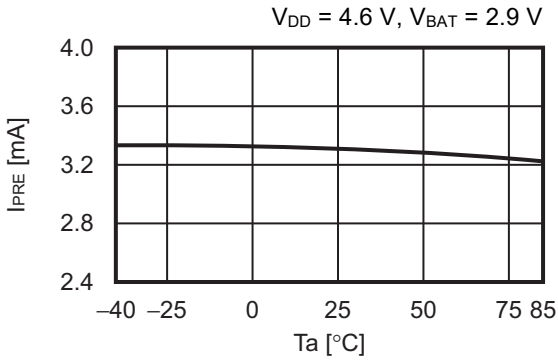

2.2 I<sub>LIM</sub> vs. Ta

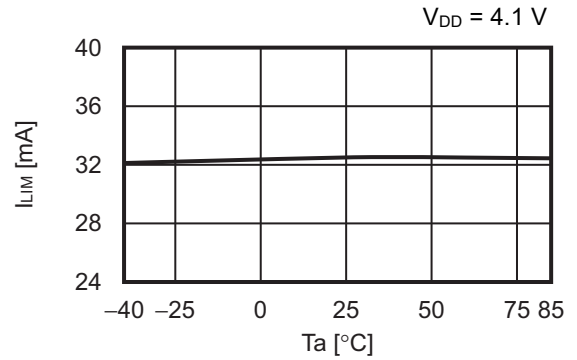

3. UVLO detection / release voltage, precharge completion voltage, charge completion voltage, overvoltage detection / release voltage, recharge start voltage, short-circuit detection / release voltage

3.1  $V_{UVLO-}$  vs.  $T_a$

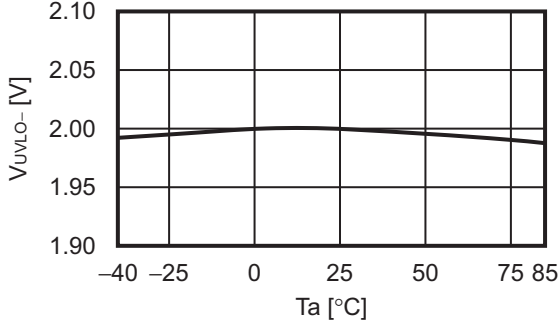

3.2  $V_{UVLO+}$  vs.  $T_a$

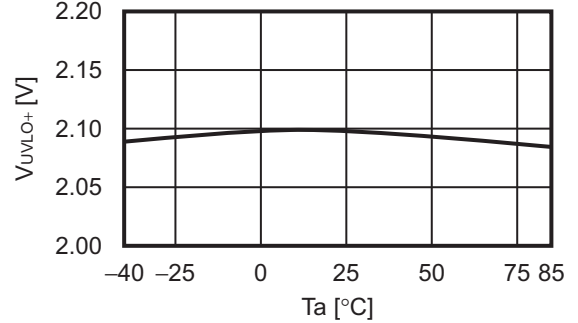

3.3  $V_{PREH}$  vs.  $T_a$

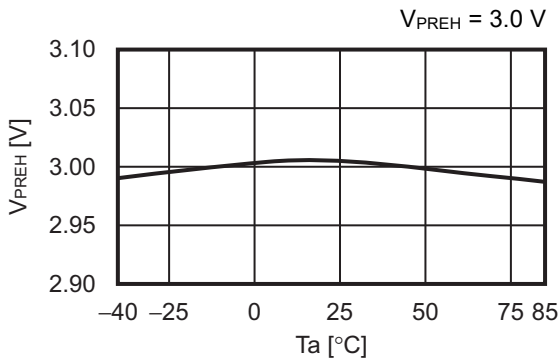

3.4  $V_{END}$  vs.  $T_a$

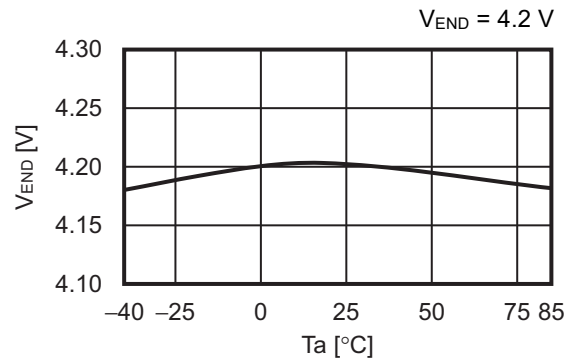

3.5  $V_{OVP}$  vs.  $T_a$

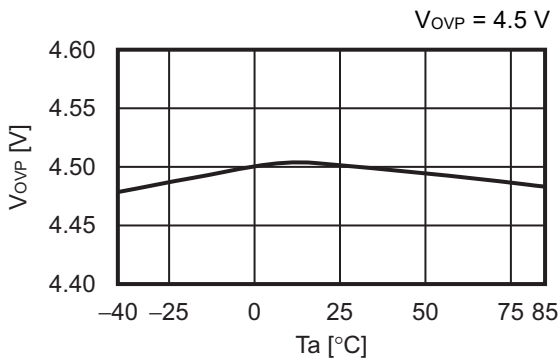

3.6  $V_{OVPR}$  vs.  $T_a$

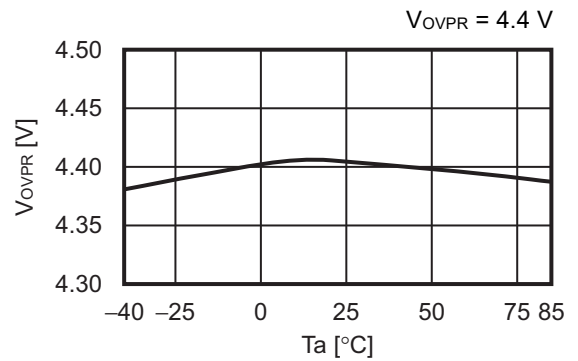

3.7  $V_{RECHG}$  vs.  $T_a$

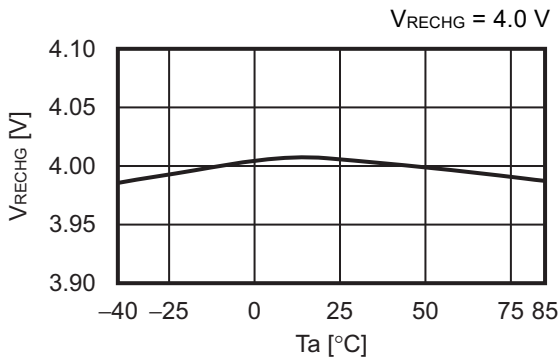

3.8  $V_{SHT}$  vs.  $T_a$

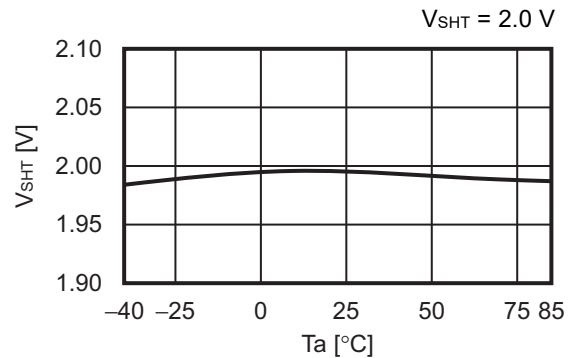

**3.9 V<sub>SHTH</sub> vs. Ta**

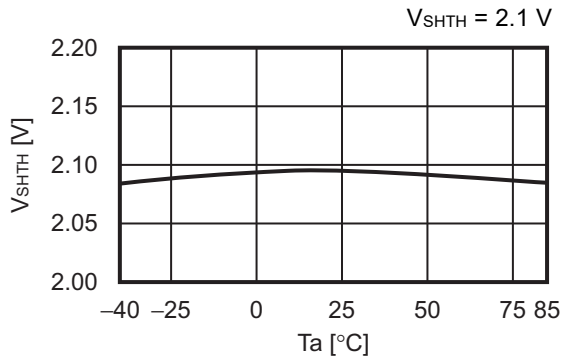

**4. Output current, Pch driver on resistance for charging, Pch driver on resistance for STATUS pin**

**4.1 I<sub>OUTN</sub> vs. Ta**

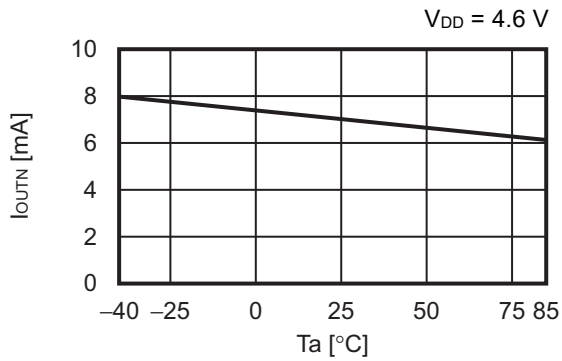

**4.2 I<sub>OUTP</sub> vs. Ta**

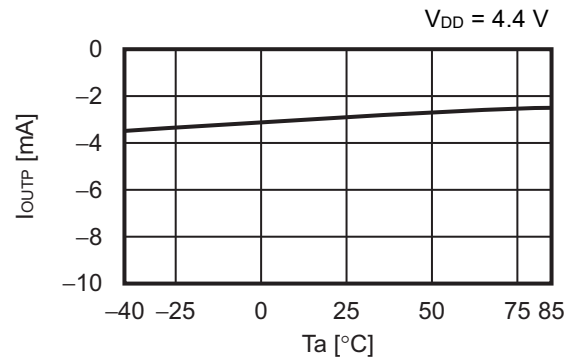

**4.3 R<sub>ONP</sub> vs. Ta**

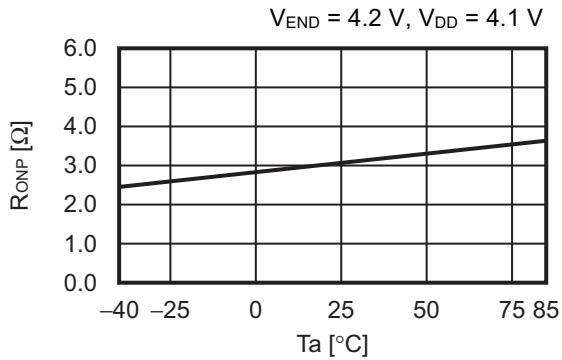

**4.4 R<sub>ONPST</sub> vs. Ta**

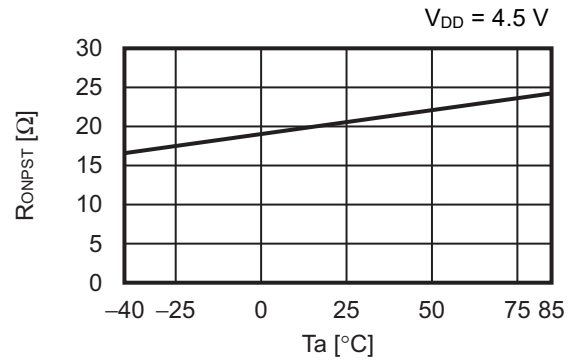



5. TH pin internal resistance, TH pin high temperature protection detection / release voltage, TH pin low temperature protection detection / release voltage

5.1  $R_{LIN}$  vs.  $V_{DD}$

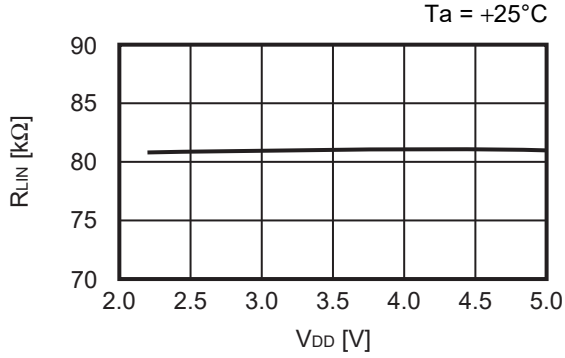

5.2  $R_{LIN}$  vs.  $T_a$

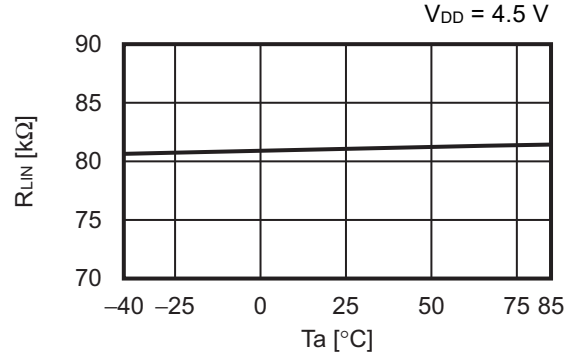

5.3  $V_{TSDH}$  vs.  $V_{DD}$

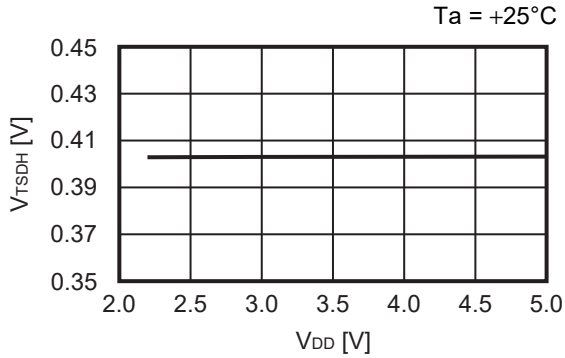

5.4  $V_{TSDH}$  vs.  $T_a$

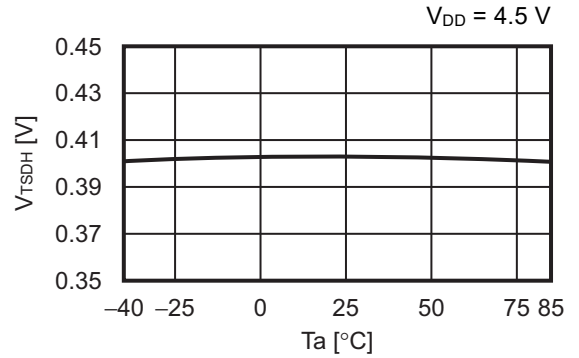

5.5  $V_{TSRH} - V_{DD}$

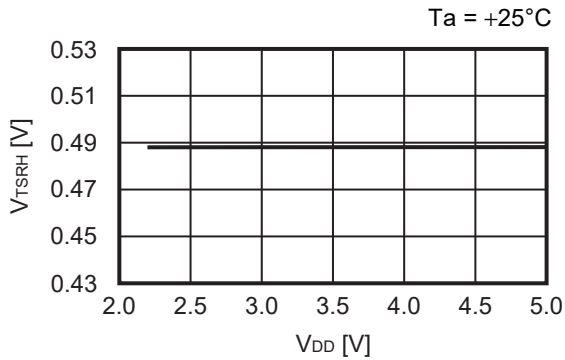

5.6  $V_{TSRH} - T_a$

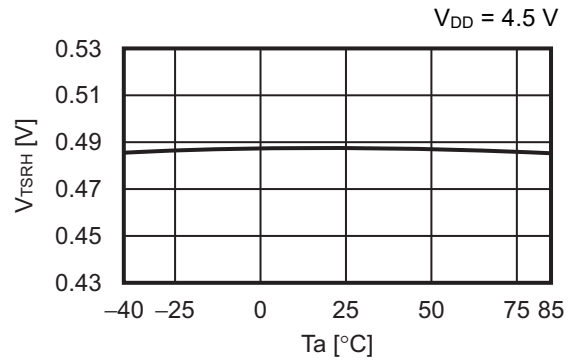

5.7  $V_{TSDL}$  vs.  $V_{DD}$

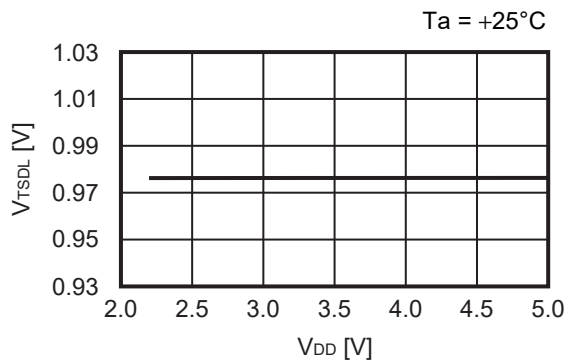

5.8  $V_{TSDL}$  vs.  $T_a$

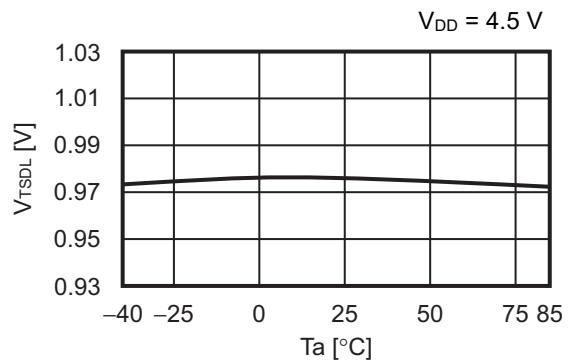

**5.9  $V_{TSRL}$  vs.  $V_{DD}$**

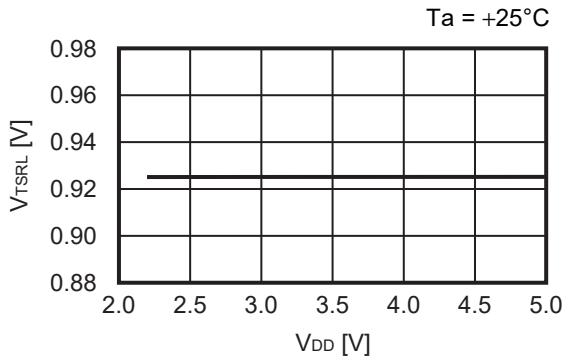

**5.10  $V_{TSRL}$  vs.  $T_a$**

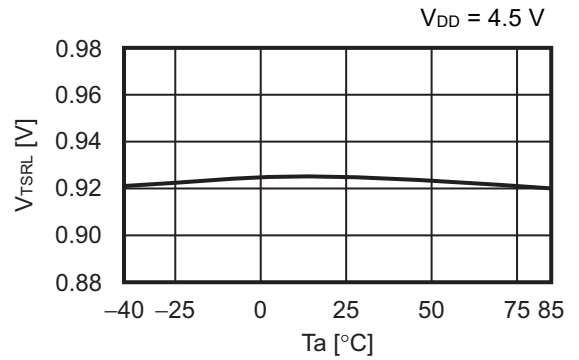

**6. Oscillation frequency for charge timer, STATUS pin blinking cycle**

**6.1  $f_{osc}$  vs.  $V_{DD}$**

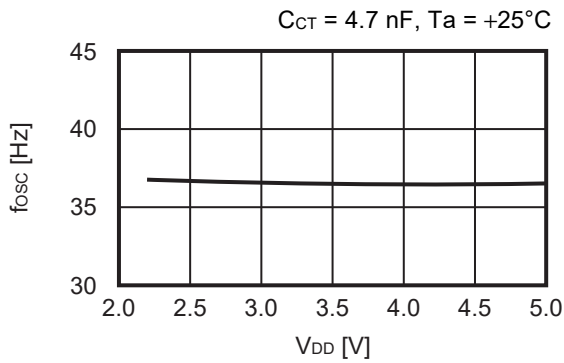

**6.2  $f_{osc}$  vs.  $T_a$**

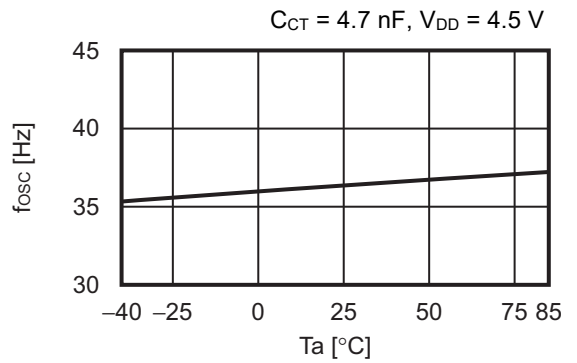

**6.3  $t_{sw}$  vs.  $V_{DD}$**

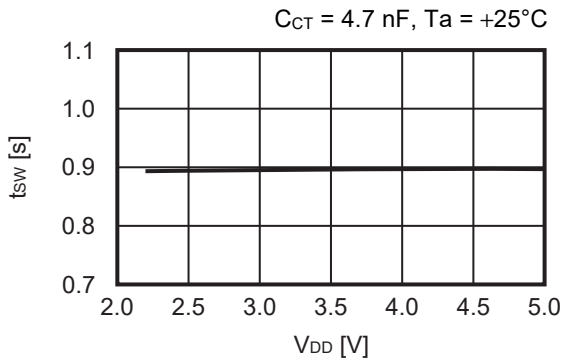

**6.4  $t_{sw}$  vs.  $T_a$**

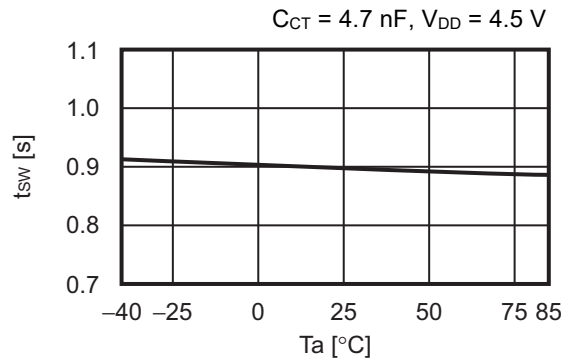

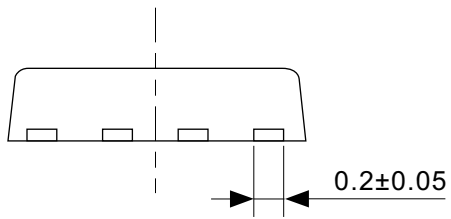
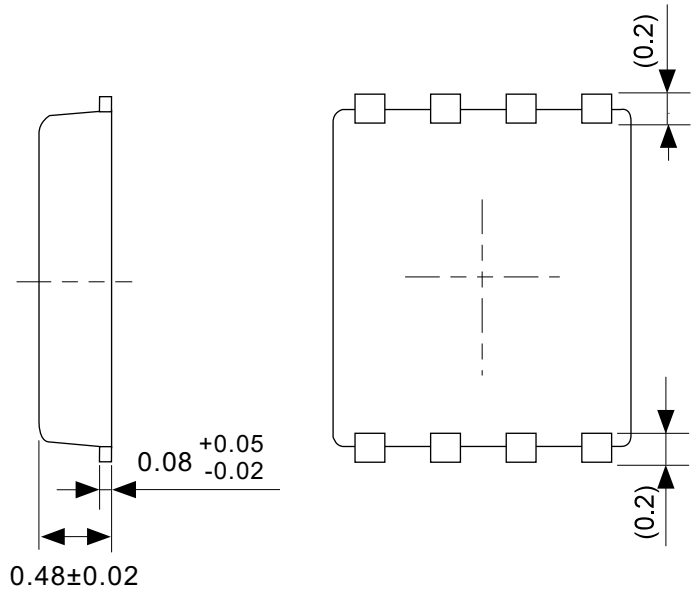
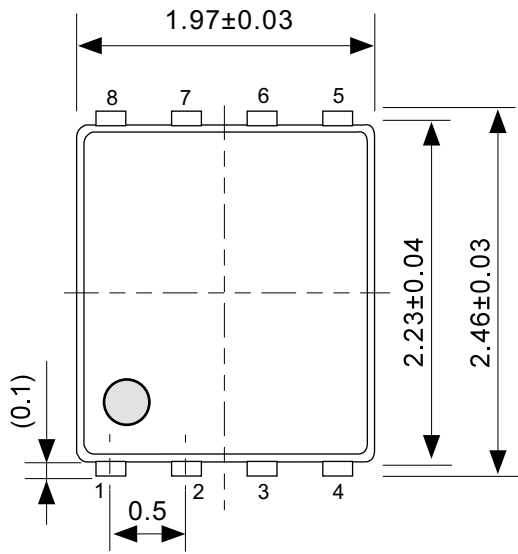

No. PH008-A-P-SD-2.1

TITLE	SNT-8A-A-PKG Dimensions
No.	PH008-A-P-SD-2.1
ANGLE	
UNIT	mm
<b>ABLIC Inc.</b>	

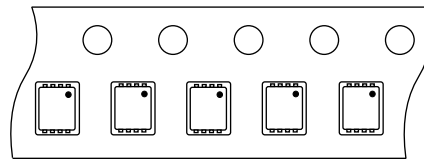
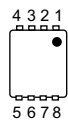
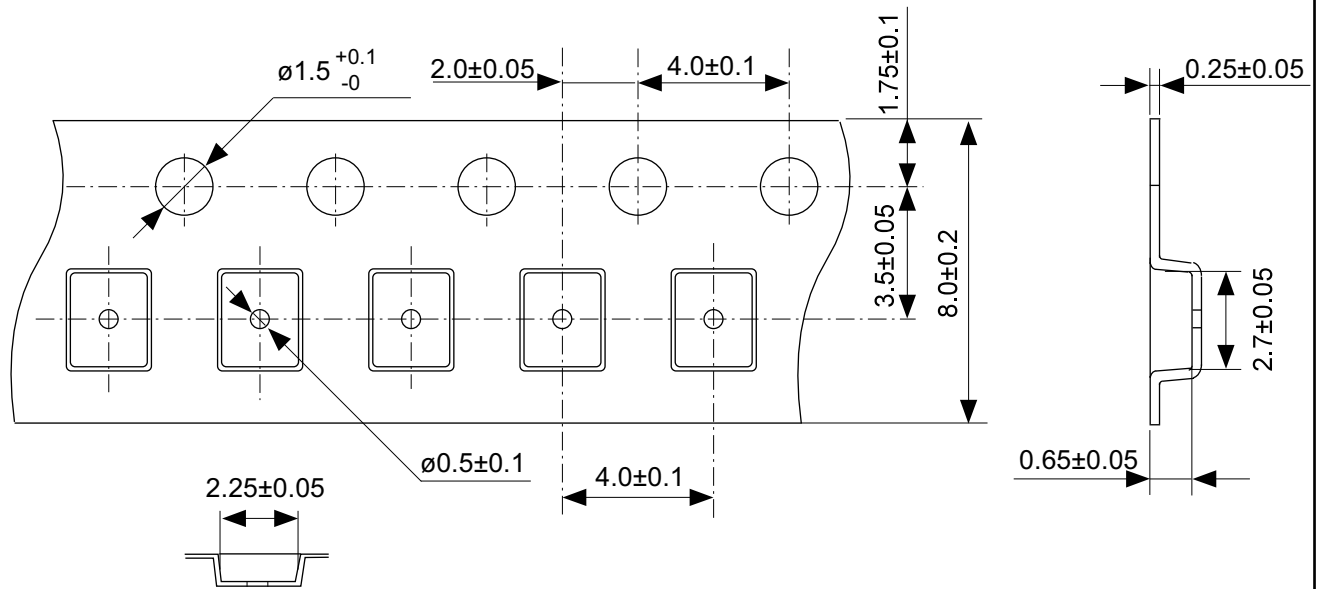

Feed direction

No. PH008-A-C-SD-2.0

TITLE	SNT-8A-A-Carrier Tape
No.	PH008-A-C-SD-2.0
ANGLE	
UNIT	mm
<b>ABLIC Inc.</b>	

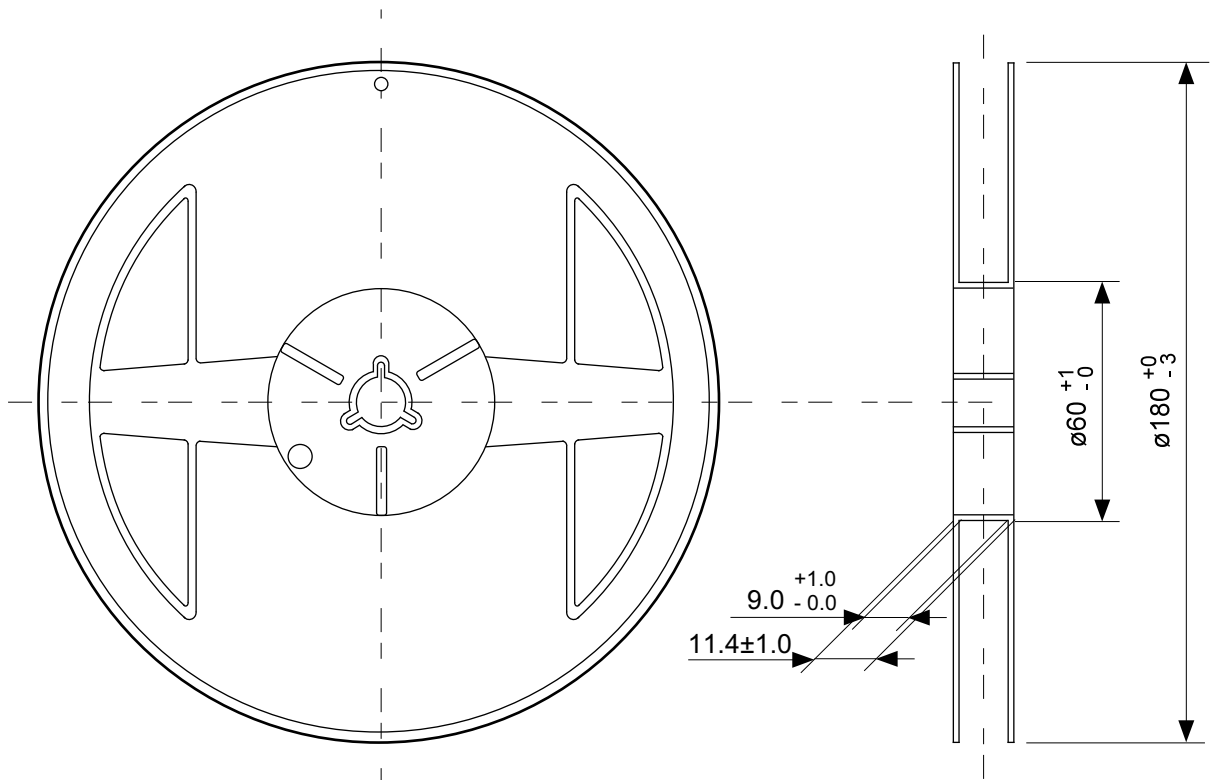

Enlarged drawing in the central part

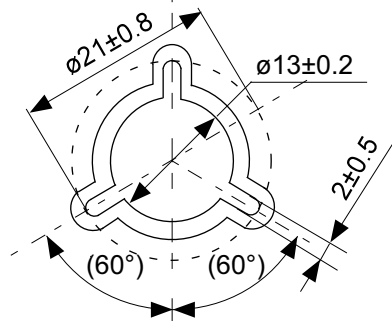

No. PH008-A-R-SD-2.0

TITLE	SNT-8A-A-Reel		
No.	PH008-A-R-SD-2.0		
ANGLE		QTY.	5,000
UNIT	mm		
<b>ABLIC Inc.</b>			

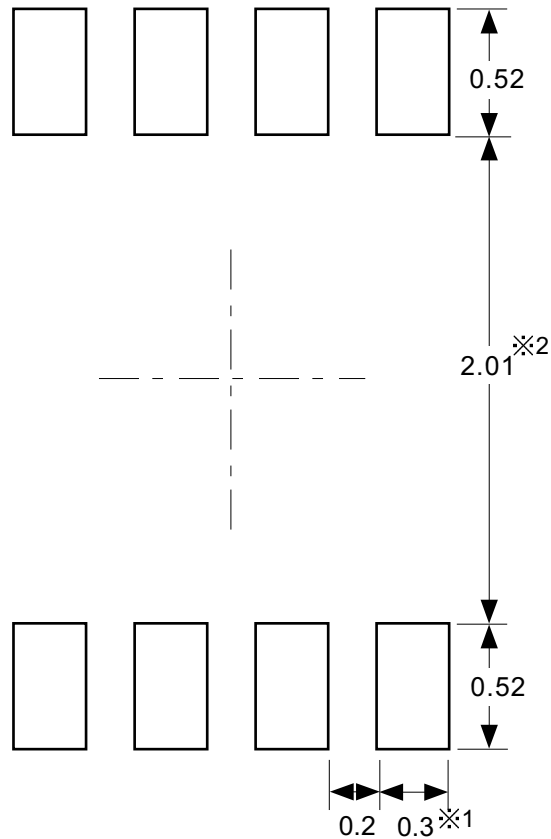

※1. ランドパターンの幅に注意してください (0.25 mm min. / 0.30 mm typ.).  
 ※2. パッケージ中央にランドパターンを広げないでください (1.96 mm ~ 2.06 mm)。

- 注意
1. パッケージのモールド樹脂下にシルク印刷やハンダ印刷などしないでください。
  2. パッケージ下の配線上のソルダーレジストなどの厚みをランドパターン表面から0.03 mm以下にしてください。
  3. マスク開口サイズと開口位置はランドパターンと合わせてください。
  4. 詳細は“SNTパッケージ活用の手引き”を参照してください。

※1. Pay attention to the land pattern width (0.25 mm min. / 0.30 mm typ.).  
 ※2. Do not widen the land pattern to the center of the package (1.96 mm to 2.06mm).

- Caution**
1. Do not do silkscreen printing and solder printing under the mold resin of the package.
  2. The thickness of the solder resist on the wire pattern under the package should be 0.03 mm or less from the land pattern surface.
  3. Match the mask aperture size and aperture position with the land pattern.
  4. Refer to "SNT Package User's Guide" for details.

※1. 请注意焊盘模式的宽度 (0.25 mm min. / 0.30 mm typ.).  
 ※2. 请勿向封装中间扩展焊盘模式 (1.96 mm ~ 2.06 mm)。

- 注意
1. 请勿在树脂型封装的下面印刷丝网、焊锡。
  2. 在封装下、布线上的阻焊膜厚度 (从焊盘模式表面起) 请控制在 0.03 mm 以下。
  3. 钢网的开口尺寸和开口位置请与焊盘模式对齐。
  4. 详细内容请参阅 "SNT 封装的应用指南"。

No. PH008-A-L-SD-4.1

TITLE	SNT-8A-A -Land Recommendation
No.	PH008-A-L-SD-4.1
ANGLE	
UNIT	mm
<b>ABLIC Inc.</b>	

## Disclaimers (Handling Precautions)

1. All the information described herein (product data, specifications, figures, tables, programs, algorithms and application circuit examples, etc.) is current as of publishing date of this document and is subject to change without notice.
2. The circuit examples and the usages described herein are for reference only, and do not guarantee the success of any specific mass-production design.  
ABLIC Inc. is not liable for any losses, damages, claims or demands caused by the reasons other than the products described herein (hereinafter "the products") or infringement of third-party intellectual property right and any other right due to the use of the information described herein.
3. ABLIC Inc. is not liable for any losses, damages, claims or demands caused by the incorrect information described herein.
4. Be careful to use the products within their ranges described herein. Pay special attention for use to the absolute maximum ratings, operation voltage range and electrical characteristics, etc.  
ABLIC Inc. is not liable for any losses, damages, claims or demands caused by failures and / or accidents, etc. due to the use of the products outside their specified ranges.
5. Before using the products, confirm their applications, and the laws and regulations of the region or country where they are used and verify suitability, safety and other factors for the intended use.
6. When exporting the products, comply with the Foreign Exchange and Foreign Trade Act and all other export-related laws, and follow the required procedures.
7. The products are strictly prohibited from using, providing or exporting for the purposes of the development of weapons of mass destruction or military use. ABLIC Inc. is not liable for any losses, damages, claims or demands caused by any provision or export to the person or entity who intends to develop, manufacture, use or store nuclear, biological or chemical weapons or missiles, or use any other military purposes.
8. The products are not designed to be used as part of any device or equipment that may affect the human body, human life, or assets (such as medical equipment, disaster prevention systems, security systems, combustion control systems, infrastructure control systems, vehicle equipment, traffic systems, in-vehicle equipment, aviation equipment, aerospace equipment, and nuclear-related equipment), excluding when specified for in-vehicle use or other uses by ABLIC, Inc. Do not apply the products to the above listed devices and equipments.  
ABLIC Inc. is not liable for any losses, damages, claims or demands caused by unauthorized or unspecified use of the products.
9. In general, semiconductor products may fail or malfunction with some probability. The user of the products should therefore take responsibility to give thorough consideration to safety design including redundancy, fire spread prevention measures, and malfunction prevention to prevent accidents causing injury or death, fires and social damage, etc. that may ensue from the products' failure or malfunction.  
The entire system in which the products are used must be sufficiently evaluated and judged whether the products are allowed to apply for the system on customer's own responsibility.
10. The products are not designed to be radiation-proof. The necessary radiation measures should be taken in the product design by the customer depending on the intended use.
11. The products do not affect human health under normal use. However, they contain chemical substances and heavy metals and should therefore not be put in the mouth. The fracture surfaces of wafers and chips may be sharp. Be careful when handling these with the bare hands to prevent injuries, etc.
12. When disposing of the products, comply with the laws and ordinances of the country or region where they are used.
13. The information described herein contains copyright information and know-how of ABLIC Inc. The information described herein does not convey any license under any intellectual property rights or any other rights belonging to ABLIC Inc. or a third party. Reproduction or copying of the information from this document or any part of this document described herein for the purpose of disclosing it to a third-party is strictly prohibited without the express permission of ABLIC Inc.
14. For more details on the information described herein or any other questions, please contact ABLIC Inc.'s sales representative.
15. This Disclaimers have been delivered in a text using the Japanese language, which text, despite any translations into the English language and the Chinese language, shall be controlling.

2.4-2019.07