

**Dual diodes  
Power Module**

**$V_{RRM} = 200V$   
 $I_C = 400A @ T_c = 80^\circ C$**

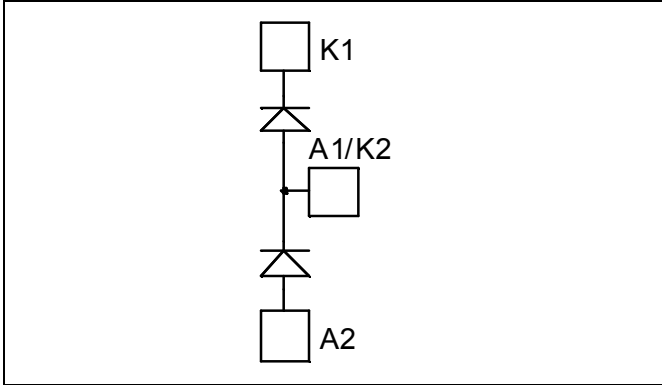

**Application**

- Anti-Parallel diode
- Uninterruptible Power Supply (UPS)
- Induction heating
- Welding equipment
- High speed rectifiers

**Features**

- Ultra fast recovery times
- Soft recovery characteristics
- Very low stray inductance
- High blocking voltage
- High current
- Low leakage current
- Very low stray inductance
  - Symmetrical design
  - M5 power connectors
- High level of integration

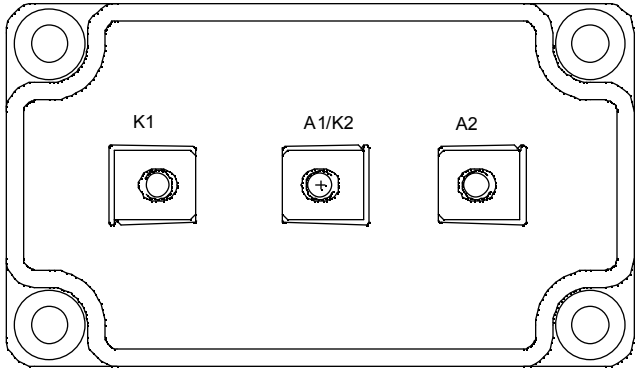

**Benefits**

- Outstanding performance at high frequency operation
- Low losses
- Low noise switching
- Direct mounting to heatsink (isolated package)
- Low junction to case thermal resistance

**Absolute maximum ratings**

Symbol	Parameter	Max ratings	Unit	
$V_R$	Maximum DC reverse Voltage	200	V	
$V_{RRM}$	Maximum Peak Repetitive Reverse Voltage			
$I_{F(AV)}$	Maximum Average Forward Current	Duty cycle = 50%	$T_C = 25^\circ C$	A
			$T_C = 80^\circ C$	
$I_{F(RMS)}$	RMS Forward Current	Duty cycle = 50%	$T_C = 45^\circ C$	
$I_{FSM}$	Non-Repetitive Forward Surge Current	8.3ms	$T_C = 45^\circ C$	

**CAUTION:** These Devices are sensitive to Electrostatic Discharge. Proper Handling Procedures Should Be Followed.

All ratings @  $T_j = 25^\circ\text{C}$  unless otherwise specified

### Electrical Characteristics

Symbol	Characteristic	Test Conditions		Min	Typ	Max	Unit
$V_F$	Diode Forward Voltage	$I_F = 400\text{A}$			1.0	1.1	V
		$I_F = 800\text{A}$			1.4		
		$I_F = 400\text{A}$	$T_j = 125^\circ\text{C}$		0.9		
$I_{RM}$	Maximum Reverse Leakage Current	$V_R = 200\text{V}$	$T_j = 25^\circ\text{C}$			750	$\mu\text{A}$
			$T_j = 125^\circ\text{C}$			1000	
$C_T$	Junction Capacitance	$V_R = 200\text{V}$			1600		pF

### Dynamic Characteristics

Symbol	Characteristic	Test Conditions		Min	Typ	Max	Unit
$t_{rr}$	Reverse Recovery Time	$I_F = 1\text{A}, V_R = 30\text{V}$ $di/dt = 400\text{A}/\mu\text{s}$	$T_j = 25^\circ\text{C}$		39		ns
$t_{rr}$	Reverse Recovery Time	$I_F = 400\text{A}$ $V_R = 133\text{V}$ $di/dt = 800\text{A}/\mu\text{s}$	$T_j = 25^\circ\text{C}$		60		ns
			$T_j = 125^\circ\text{C}$		110		
$Q_{rr}$	Reverse Recovery Charge		$T_j = 25^\circ\text{C}$		800		nC
			$T_j = 125^\circ\text{C}$		3360		
$I_{RRM}$	Reverse Recovery Current		$T_j = 25^\circ\text{C}$		24		A
			$T_j = 125^\circ\text{C}$		60		
$t_{rr}$	Reverse Recovery Time	$I_F = 400\text{A}$ $V_R = 133\text{V}$ $di/dt = 4000\text{A}/\mu\text{s}$	$T_j = 125^\circ\text{C}$		80		ns
$Q_{rr}$	Reverse Recovery Charge				7.64		$\mu\text{C}$
$I_{RRM}$	Reverse Recovery Current				176		A

### Thermal and package characteristics

Symbol	Characteristic	Min	Typ	Max	Unit	
$R_{thJC}$	Junction to Case			0.14	$^\circ\text{C}/\text{W}$	
$V_{ISOL}$	RMS Isolation Voltage, any terminal to case $t = 1\text{ min}$ , $I_{isol} < 1\text{mA}$ , 50/60Hz	2500			V	
$T_j$	Operating junction temperature range	-40		150	$^\circ\text{C}$	
$T_{STG}$	Storage Temperature Range	-40		125		
$T_C$	Operating Case Temperature	-40		100		
Torque	Mounting torque	To heatsink	M6	3	5	N.m
		For terminals	M5	2	3.5	
Wt	Package Weight			280	g	

**Typical Performance Curve**

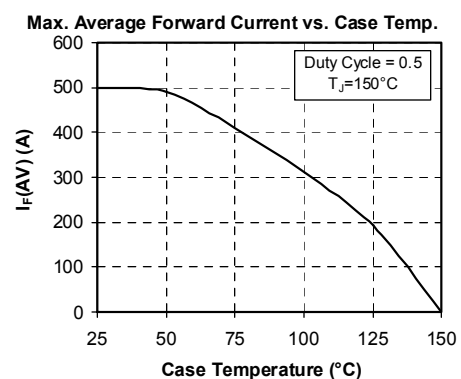
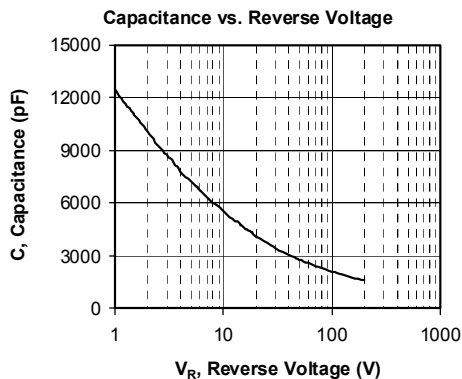
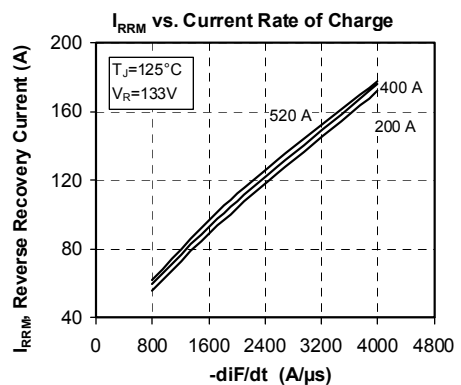
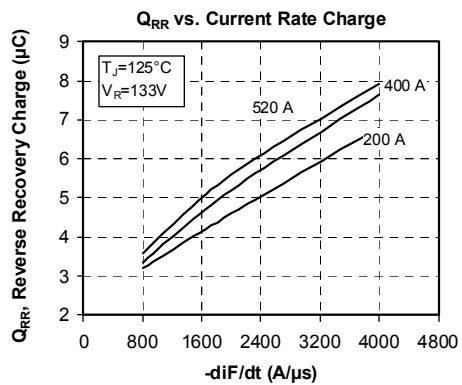
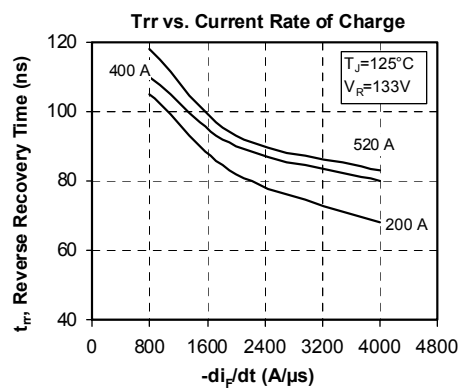
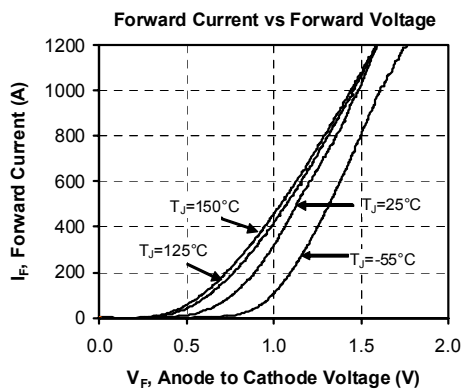
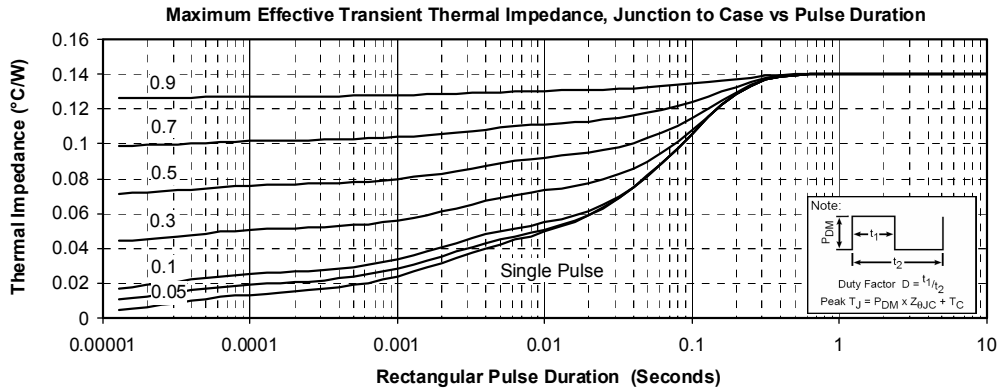

**Package outline** (dimensions in mm)



**APT reserves the right to change, without notice, the specifications and information contained herein**

APT's products are covered by one or more of U.S. patents 4,895,810 5,045,903 5,089,434 5,182,234 5,019,522 5,262,336 6,503,786 5,256,583 4,748,103 5,283,202 5,231,474 5,434,095 5,528,058 and foreign patents. U.S and Foreign patents pending. All Rights Reserved.