

APM2054N



N-Channel Enhancement Mode MOSFETE

Features

- 20V/6A, $R_{DS(ON)}=35m\Omega(\text{typ.}) @ V_{GS}=10V$
 $R_{DS(ON)}=45m\Omega(\text{typ.}) @ V_{GS}=4.5V$
- Super High Dense Cell Design
- High Power and Current Handling Capability
- TO-252, SOT-89 and SOT-223 Packages

Pin Description

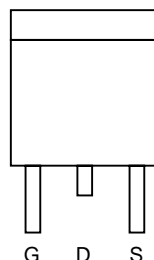

Top View of TO-252

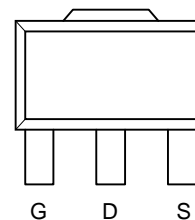

Top View of SOT-89

Applications

- Switching Regulators
- Switching Converters

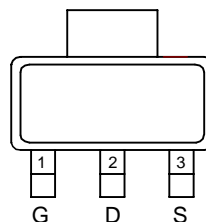

Top View of SOT-223

Ordering Information

APM2054N		Handling Code	Package Code
		Temp. Range	Temp. Range
		TR : Tape & Reel	

Package Code
 D : SOT-89 V : SOT-223
 U : TO-252
 Temp. Range
 C : 0 to 70 °C
 Handling Code
 TR : Tape & Reel

Absolute Maximum Ratings ($T_A = 25^\circ\text{C}$ unless otherwise noted)

Symbol	Parameter	Rating	Unit
V_{DSS}	Drain-Source Voltage	20	V
V_{GSS}	Gate-Source Voltage	± 16	
I_D	Maximum Drain Current – Continuous	6	A
I_{DM}	Maximum Drain Current – Pulsed	20	

ANPEC reserves the right to make changes to improve reliability or manufacturability without notice, and advise customers to obtain the latest version of relevant information to verify before placing orders.

APM2054N



Absolute Maximum Ratings ($T_A = 25^\circ\text{C}$ unless otherwise noted)

Symbol	Parameter	Rating	Unit		
P_D	Maximum Power Dissipation	$T_A=25^\circ\text{C}$	TO-252	50	W
			SOT-223/SOT-89	3	
		$T_A=100^\circ\text{C}$	TO-252	10	W
			SOT-223/SOT-89	1.2	
T_J	Maximum Junction Temperature	150	$^\circ\text{C}$		
T_{STG}	Storage Temperature Range	-55 to 150	$^\circ\text{C}$		

Electrical Characteristics ($T_A=25^\circ\text{C}$ unless otherwise noted)

Symbol	Parameter	Test Condition	APM2054N			Unit
			Min.	Typ.	Max.	
Static						
BV_{DSS}	Drain-Source Breakdown Voltage	$V_{GS}=0V, I_{DS}=250\mu A$	20			V
I_{DSS}	Zero Gate Voltage Drain Current	$V_{DS}=16V, V_{GS}=0V$			1	μA
$V_{GS(th)}$	Gate Threshold Voltage	$V_{DS}=V_{GS}, I_{DS}=250\mu A$	0.6		1.5	V
I_{GSS}	Gate Leakage Current	$V_{GS}=\pm 16V, V_{DS}=0V$			± 100	nA
$R_{DS(ON)}$	Drain-Source On-state Resistance	$V_{GS}=10V, I_{DS}=12A$		35	40	m Ω
		$V_{GS}=4.5V, I_{DS}=6A$		45	54	
		$V_{GS}=2.5V, I_{DS}=2A$		110	130	
V_{SD}	Diode Forward Voltage	$I_{SD}=6A, V_{GS}=0V$	0.6		1.1	V
Dynamic						
Q_g	Total Gate Charge	$V_{DS}=10V, V_{GS}=4.5V,$ $I_{DS}=6A$		11	13	nC
Q_{gs}	Gate-Source Charge			3.8		
Q_{gd}	Gate-Drain Charge			5.2		
$t_{d(ON)}$	Turn-on Delay Time	$V_{DD}=10V, I_{DS}=1A,$ $V_{GEN}=4.5V, R_G=0.2\Omega$		12		ns
t_r	Turn-on Rise Time			10		
$t_{d(OFF)}$	Turn-off Delay Time			40		
t_f	Turn-off Fall Time			20		
C_{iss}	Input Capacitance	$V_{GS}=0V$		450		pF
C_{oss}	Output Capacitance	$V_{DS}=15V$		100		
C_{riss}	Reverse Transfer Capacitance	Frequency=1.0MHz		60		

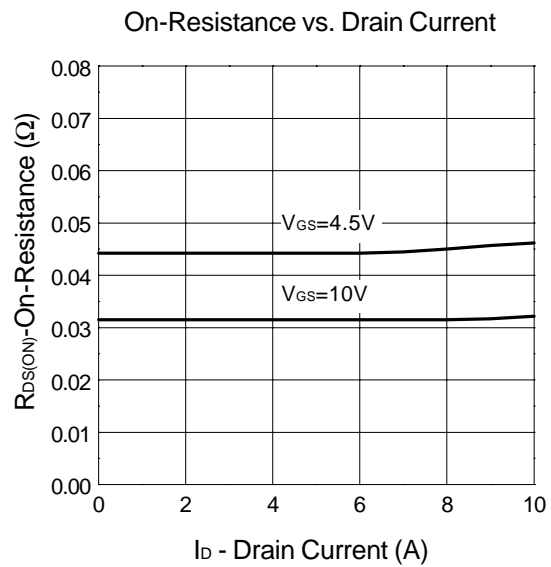
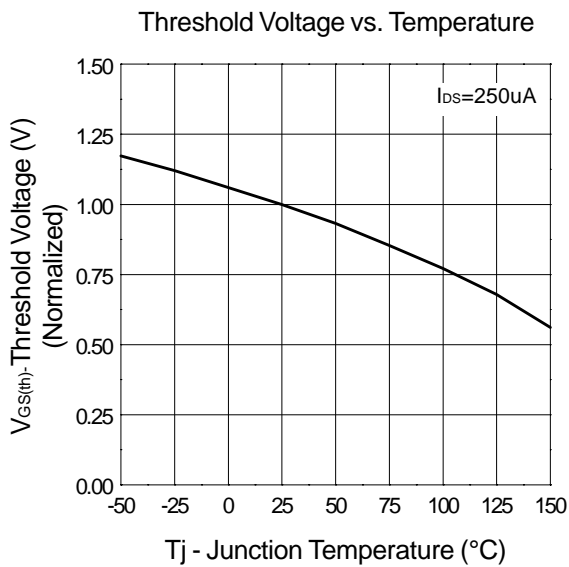
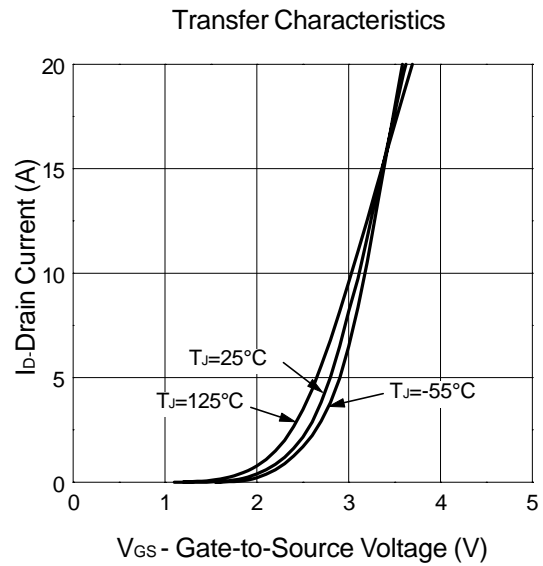
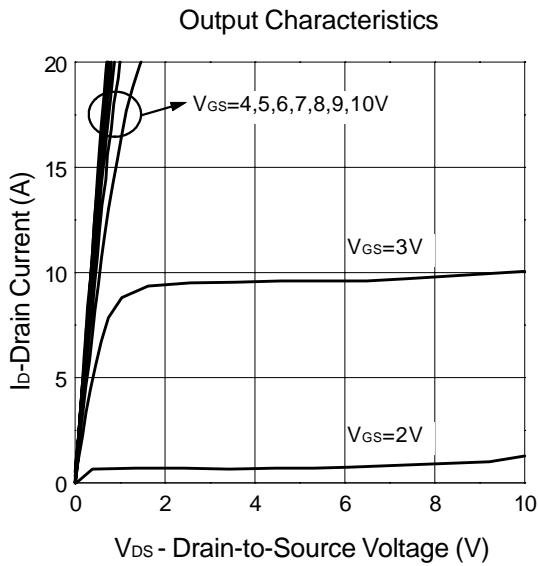
Typical Characteristics



Typical Characteristics

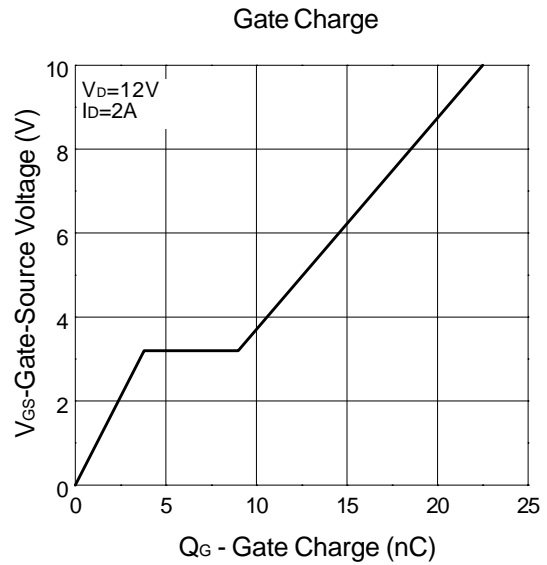
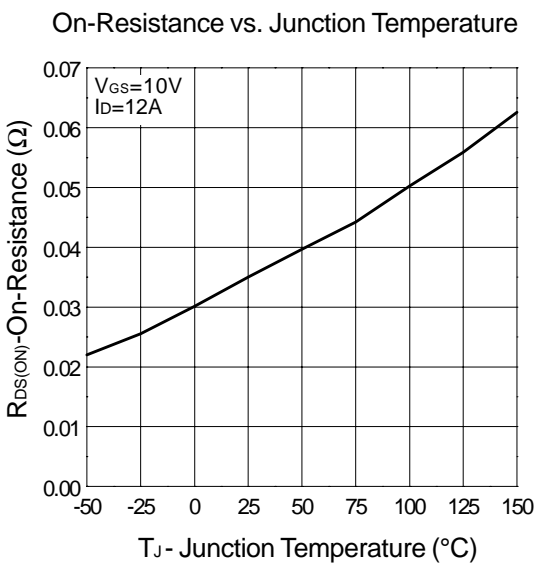
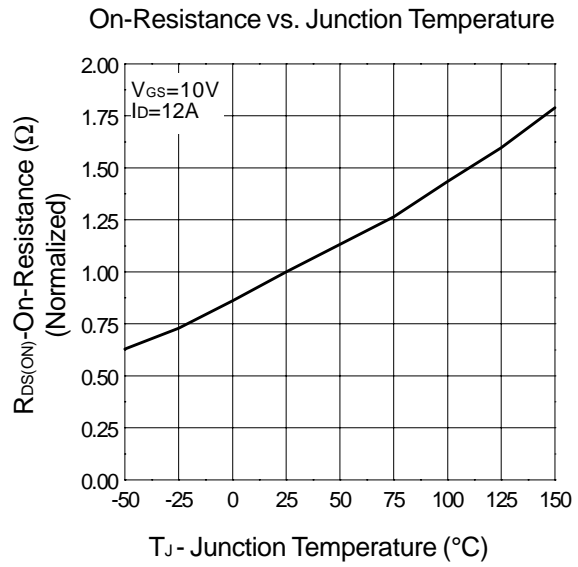
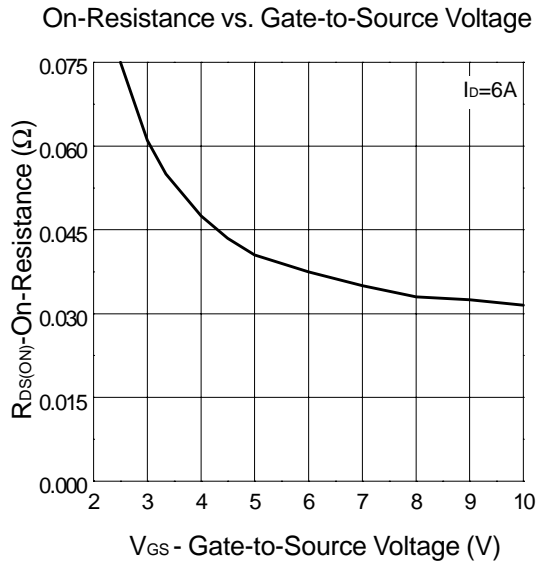

et4U.com

DataSheet4U.com

DataShe

Typical Characteristics

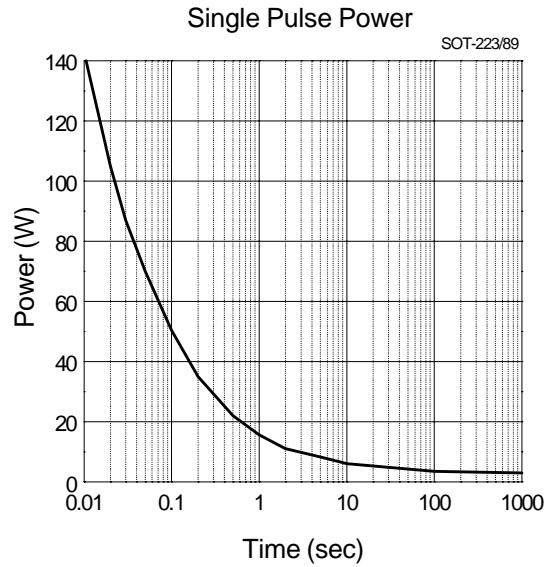
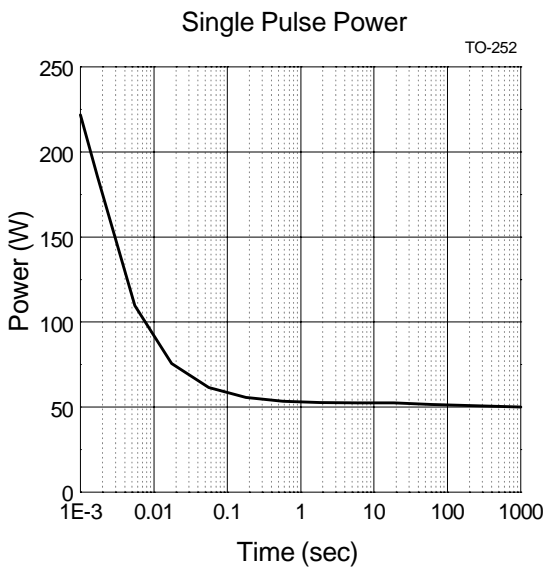
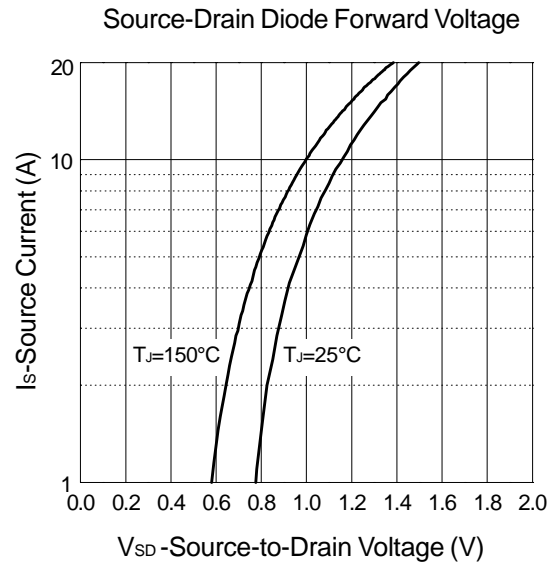
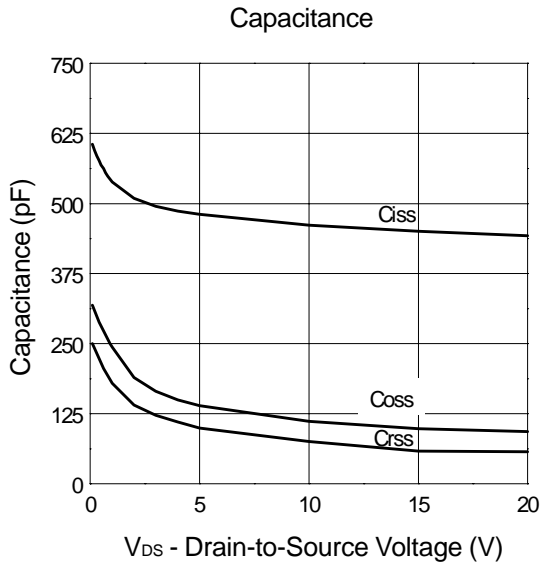

Typical Characteristics

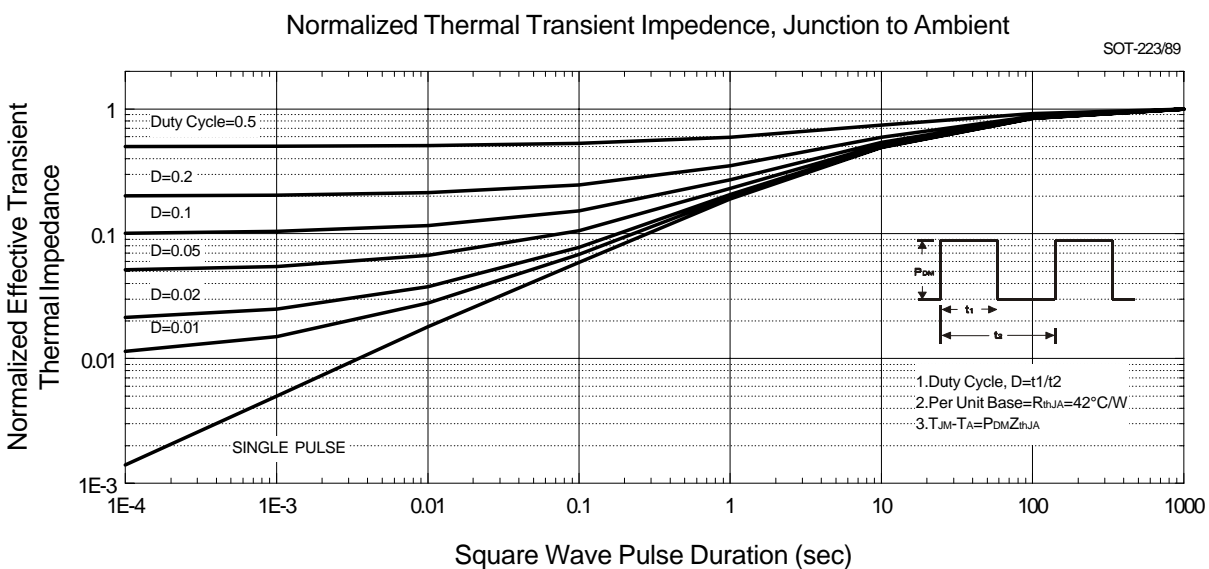
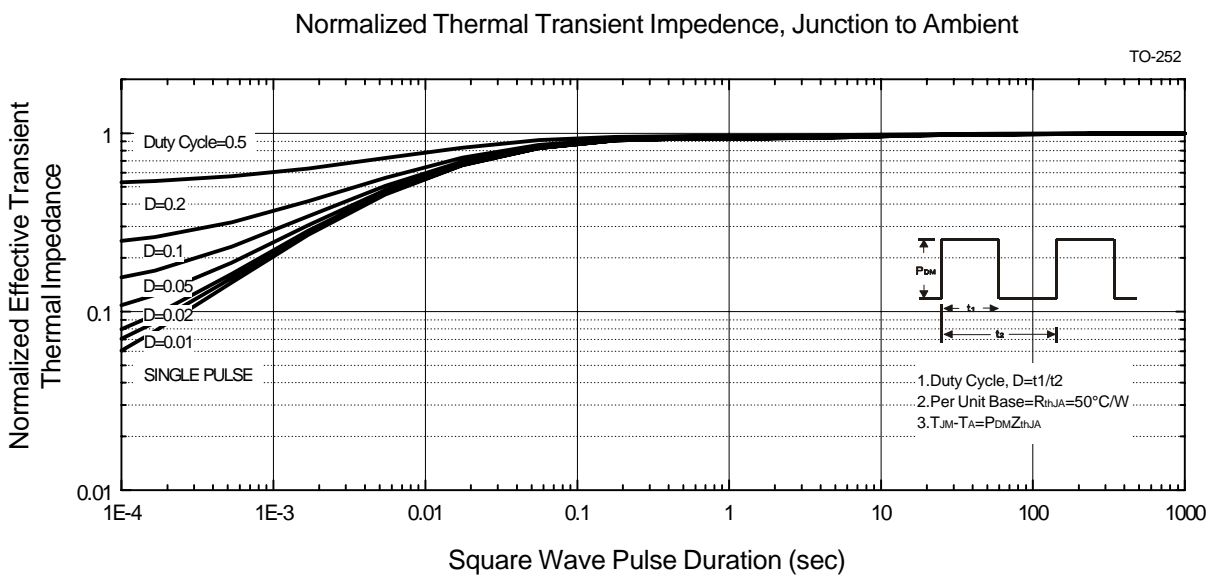

APM2054N



Package Information

TO-252(Reference JEDEC Registration TO-252)

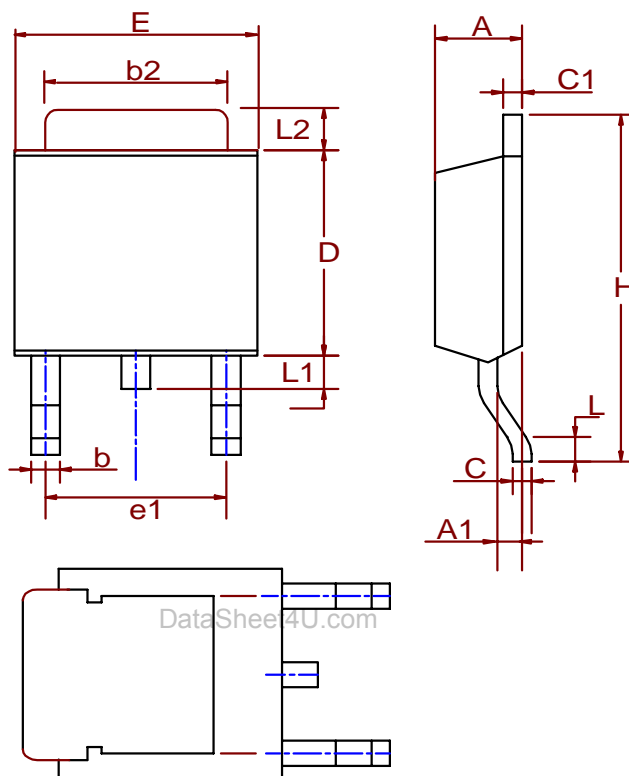

Dim	Millimeters		Inches	
	Min.	Max.	Min.	Max.
A	2.18	2.39	0.086	0.094
A1	0.89	1.27	0.035	0.050
b	0.508	0.89	0.020	0.035
b2	5.207	5.461	0.205	0.215
C	0.46	0.58	0.018	0.023
C1	0.46	0.58	0.018	0.023
D	5.334	6.22	0.210	0.245
E	6.35	6.73	0.250	0.265
e1	3.96	5.18	0.156	0.204
H	9.398	10.41	0.370	0.410
L	0.51		0.020	
L1	0.64	1.02	0.025	0.040
L2	0.89	2.032	0.035	0.080

APM2054N



Packaging Information

SOT-89 (Reference EIAJ ED-7500A Registration SC-62)

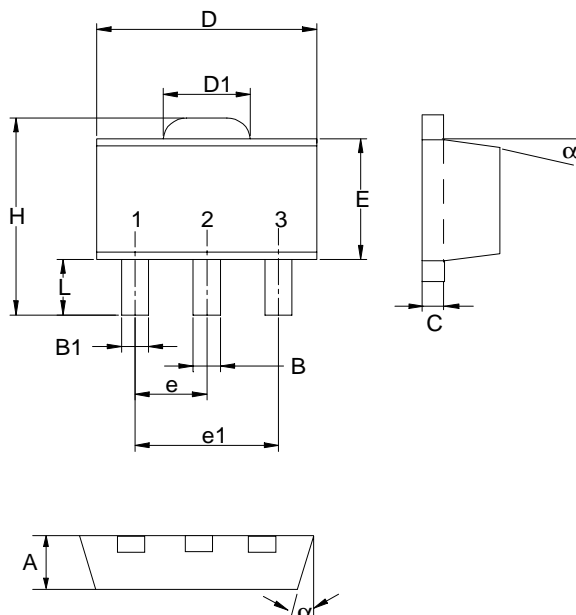

DataSheet4U.com

Dim	Millimeters		Inches	
	Min.	Max.	Min.	Max.
A	1.40	1.60	0.055	0.063
B	0.40	0.56	0.016	0.022
B1	0.35	0.48	0.014	0.019
C	0.35	0.44	0.014	0.017
D	4.40	4.60	0.173	0.181
D1	1.35	1.83	0.053	0.072
e	1.50 BSC		0.059 BSC	
e1	3.00 BSC		0.118 BSC	
E	2.29	2.60	0.090	0.102
H	3.75	4.25	0.148	0.167
L	0.80	1.20	0.031	0.047
α		10°		10°

Package Information

SOT-223(Reference JEDEC Registration SOT-223)

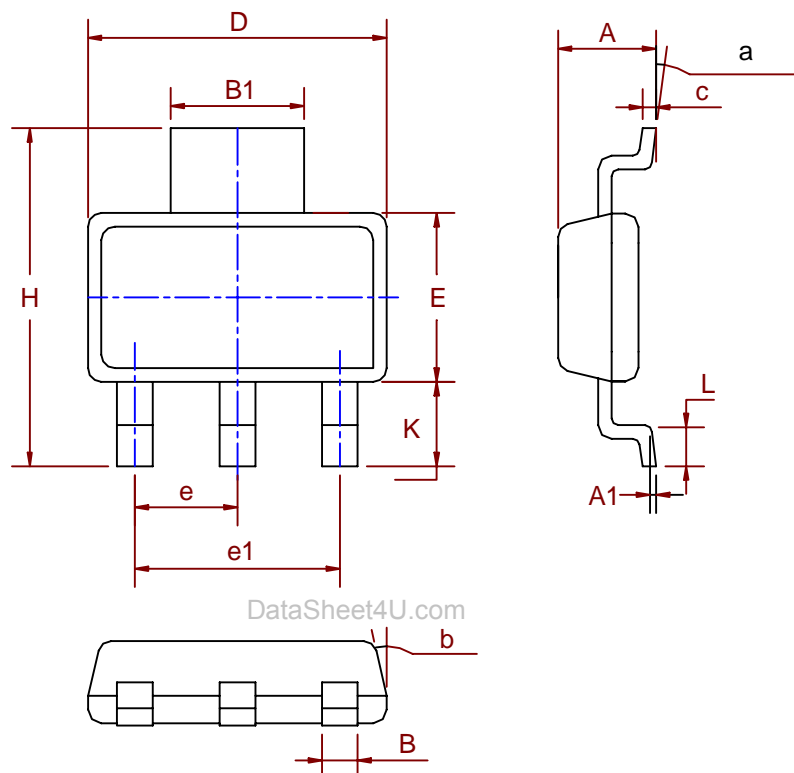

Dim	Millimeters		Inches	
	Min.	Max.	Min.	Max.
A	1.50	1.80	0.06	0.07
A1	0.02	0.08		
B	0.60	0.80	0.02	0.03
B1	2.90	3.10	0.11	0.12
c	0.28	0.32	0.01	0.01
D	6.30	6.70	0.25	0.26
E	3.30	3.70	0.13	0.15
e	2.3 BSC		0.09 BSC	
e1	4.6 BSC		0.18 BSC	
H	6.70	7.30	0.26	0.29
L	0.91	1.10	0.04	0.04
K	1.50	2.00	0.06	0.08
α	0°	10°	0°	10°
β	13°		13°	

Physical Specifications

Terminal Material	Solder-Plated Copper (Solder Material : 90/10 or 63/37 SnPb)
Lead Solderability	Meets EIA Specification RSI86-91, ANSI/J-STD-002 Category 3.
Packaging	2500 devices per reel for TO-252 and SOT-223, 1000 devices per reel for SOT-89

Reflow Condition (IR/Convection or VPR Reflow)

Reference JEDEC Standard J-STD-020A APRIL 1999

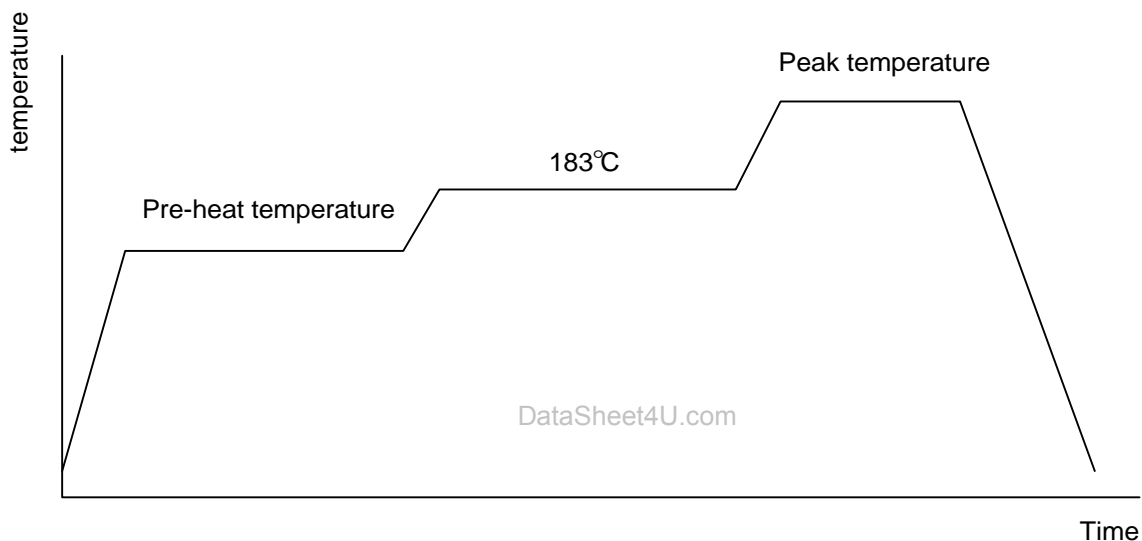

Classification Reflow Profiles

	Convection or IR/ Convection	VPR
Average ramp-up rate(183°C to Peak)	3°C/second max.	10 °C /second max.
Preheat temperature 125 ± 25°C)	120 seconds max.	
Temperature maintained above 183°C	60 ~ 150 seconds	
Time within 5°C of actual peak temperature	10 ~ 20 seconds	60 seconds
Peak temperature range	220 +5/-0°C or 235 +5/-0°C	215~ 219°C or 235 +5/-0°C
Ramp-down rate	6 °C /second max.	10 °C /second max.
Time 25°C to peak temperature	6 minutes max.	

Package Reflow Conditions

pkg. thickness ≥ 2.5mm and all bags	pkg. thickness < 2.5mm and pkg. volume ≥ 350 mm ³	pkg. thickness < 2.5mm and pkg. volume < 350mm ³
Convection 220 +5/-0 °C		Convection 235 +5/-0 °C
VPR 215-219 °C		VPR 235 +5/-0 °C
IR/Convection 220 +5/-0 °C		IR/Convection 235 +5/-0 °C

Reliability test program

Test item	Method	Description
SOLDERABILITY	MIL-STD-883D-2003	245°C , 5 SEC
HOLT	MIL-STD-883D-1005.7	1000 Hrs Bias @ 125 °C
PCT	JESD-22-B, A102	168 Hrs, 100 % RH , 121°C
TST	MIL-STD-883D-1011.9	-65°C ~ 150°C, 200 Cycles

Carrier Tape & Reel Dimensions

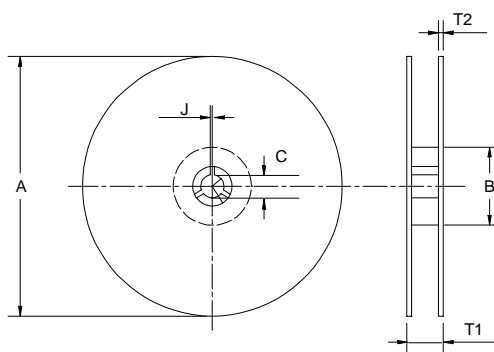
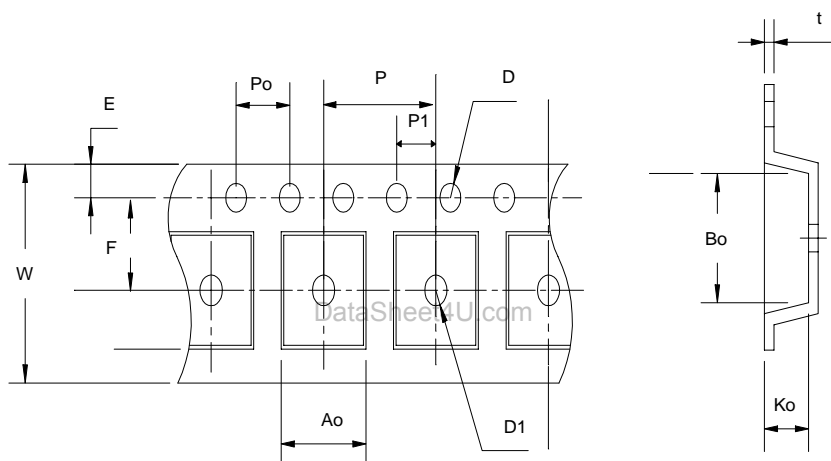

APM2054N



Carrier Tape & Reel Dimensions(Cont.)

Application	A	B	C	J	T1	T2	W	P	E
TO-252	330 ±3	100 ± 2	13 ± 0.5	2 ± 0.5	16.4 + 0.3 -0.2	2.5 ± 0.5	16 + 0.3 -0.1	8 ± 0.1	1.75 ± 0.1
	F	D	D1	Po	P1	Ao	Bo	Ko	t
	7.5 ± 0.1	1.5 ± 0.1	1.5 ± 0.25	4.0 ± 0.1	2.0 ± 0.1	6.8 ± 0.1	10.4 ± 0.1	2.5 ± 0.1	0.3 ± 0.05
Application	A	B	C	J	T1	T2	W	P	E
SOT-89	178 ±1	70 ± 2	13.5 ± 0.15	3 ± 0.15	14 ± 2	1.3 ± 0.3	12 + 0.3 12 - 0.1	8 ± 0.1	1.75 ± 0.1
	F	D	D1	Po	P1	Ao	Bo	Ko	t
	5.5 ± 0.05	1.5 ± 0.1	1.5 ± 0.1	4.0 ± 0.1	2.0 ± 0.1	4.8 ± 0.1	4.5 ± 0.1	1.80 ± 0.1	0.3 ± 0.013
Application	A	B	C	J	T1	T2	W	P	E
SOT-223	330 ±1	62 ± 1.5	12.75 ± 0.15	2 ± 0.6	12.4 ± 0.2	2 ± 0.2	12 ± 0.3	8 ± 0.1	1.75 ± 0.1
	F	D	D1	Po	P1	Ao	Bo	Ko	t
	5.5 ± 0.05	1.5 ± 0.1	1.5 ± 0.1	4.0 ± 0.1	2.0 ± 0.05	6.9 ± 0.1	7.5 ± 0.1	2.1 ± 0.1	0.3 ± 0.05

(mm)

Cover Tape Dimensions

Application	Carrier Width	Cover Tape Width
SOT-89	12	9.3
SOT- 223	12	9.3
TO- 252	16	13.3

(mm)

Customer Service

Anpec Electronics Corp.

Head Office :

5F, No. 2 Li-Hsin Road, SBIP,

Hsin-Chu, Taiwan, R.O.C.

Tel : 886-3-5642000

Fax : 886-3-5642050

Taipei Branch :

7F, No. 137, Lane 235, Pac Chiao Rd.,

Hsin Tien City, Taipei Hsien, Taiwan, R. O. C.

Tel : 886-2-89191368

Fax : 886-2-89191369