

Precision IC-sockets, machined contacts, pitch 2,54mm, pin length 7,43mm

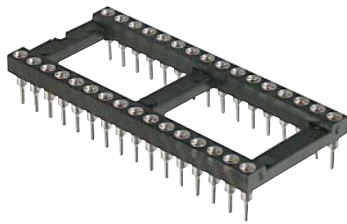

Pin
Brass, machined

Clip
4 finger contact

Plating
HZL = pin - tin /
Clip - gold flash
HGL = pin - gold flash /
Clip - gold flash

Insulator
Polyamide UL94V-0

Current rating
3A

Contact resistance
<4mΩ / contact

Insulation resistance
>1000MΩ at 100V

Operating temperature
HZL = -40°C to +105°C
HGL = -55°C to +125°C

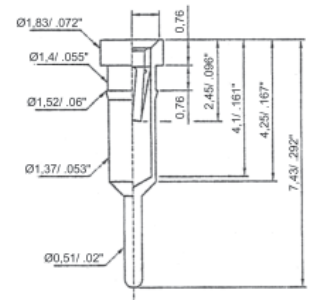
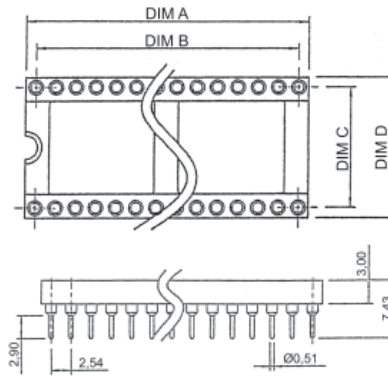

No. of Contacts	Qty per tube	Dimension			
		A	B	C	D
06	80	7,62	5,08	7,62	10,16
08	58	10,16	7,62	7,62	10,16
10	45	12,70	10,16	7,62	10,16
14	33	17,78	15,24	7,62	10,16
16	29	20,32	17,78	7,62	10,16
18	26	22,86	20,32	7,62	10,16
20	23	25,40	22,86	7,62	10,16
24	19	30,48	27,94	15,24	17,78
24*	19	30,48	27,94	7,62	10,16
28	16	35,56	33,02	15,24	17,78
28*	16	35,56	33,02	7,62	10,16
32	14	40,64	38,10	15,24	17,78
40	11	50,80	48,26	15,24	17,78

NOTE: ABOVE LAYOUT MAY CONTAIN VARIANCES. FOR A DETAILED DRAWING PLEASE CALL 1-877-277-6266 OR GO TO www.usa-assmann.com

Assmann Part Number Basic Stocking Parts	Contacts	Version	Assmann Part Number Basic Stocking Parts	Contacts	Version	Assmann Part Number Basic Stocking Parts	Contacts	Version	Assmann Part Number Basic Stocking Parts	Contacts	Version
AR06-HGL-TT-R	6	Gold	AR06-HZL-TT-R	6	Tin	AR06-HZL/07-TT-R	6	Tin/ Clip 30u" Gold	AR06-HZL/01-TT-R	6	Tin/ Clip 10u" Gold
AR08-HGL-TT-R	8	Gold	AR08-HZL-TT-R	8	Tin	AR08-HZL/07-TT-R	8	Tin/ Clip 30u" Gold	AR08-HZL/01-TT-R	8	Tin/ Clip 10u" Gold
AR14-HGL-TT-R	14	Gold	AR14-HZL-TT-R	14	Tin	AR14-HZL/07-TT-R	14	Tin/ Clip 30u" Gold	AR14-HZL/01-TT-R	14	Tin/ Clip 10u" Gold
AR16-HGL-TT-R	16	Gold	AR16-HZL-TT-R	16	Tin	AR16-HZL/07-TT-R	16	Tin/ Clip 30u" Gold	AR16-HZL/01-TT-R	16	Tin/ Clip 10u" Gold
AR18-HGL-TT-R	18	Gold	AR18-HZL-TT-R	18	Tin	AR18-HZL/07-TT-R	18	Tin/ Clip 30u" Gold	AR18-HZL/01-TT-R	18	Tin/ Clip 10u" Gold
AR22-HGL-TT-R	22	Gold	AR22-HZL-TT-R	22	Tin	AR22-HZL/07-TT-R	22	Tin/ Clip 30u" Gold	AR22-HZL/01-TT-R	22	Tin/ Clip 10u" Gold
AR24-HGL-TT-R	24	Gold	AR24-HZL-TT-R	24	Tin	AR24-HZL/07-TT-R	24	Tin/ Clip 30u" Gold	AR24-HZL/01-TT-R	24	Tin/ Clip 10u" Gold
AR28-HGL-TT-R	28	Gold	AR28-HZL-TT-R	28	Tin	AR28-HZL/07-TT-R	28	Tin/ Clip 30u" Gold	AR28-HZL/01-TT-R	28	Tin/ Clip 10u" Gold
AR32-HGL-TT-R	32	Gold	AR32-HZL-TT-R	32	Tin	AR32-HZL/07-TT-R	32	Tin/ Clip 30u" Gold	AR32-HZL/01-TT-R	32	Tin/ Clip 10u" Gold
AR40-HGL-TT-R	40	Gold	AR40-HZL-TT-R	40	Tin	AR40-HZL/07-TT-R	40	Tin/ Clip 30u" Gold	AR40-HZL/01-TT-R	40	Tin/ Clip 10u" Gold

Precision IC-sockets, wire-wrap-version, pitch 2,54mm, pin length 17,80mm

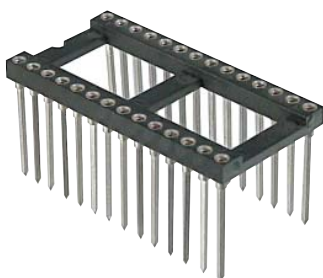

Pin
Brass, machined, CuZn38Pb2

Clip
4-finger contact

Plating
Pin - tin /
Clip - gold flash

Insulator body
Polyamide, UL94V-0

Current rating
3A

Contact resistance
<4mΩ / contact

Insulation resistance
>1000MΩ at 100V

Operating temperature
-40°C to +105°C

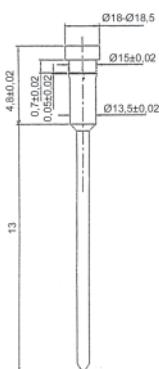
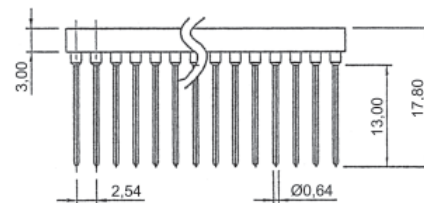
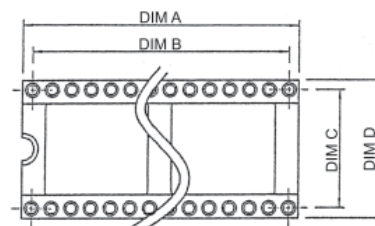
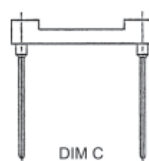

No. of Contacts	Dimension			
	A	B	C	D
08	10,16	7,62	7,62	10,16
14	17,78	15,24	7,62	10,16
16	20,32	17,78	7,62	10,16
18	22,86	20,32	7,62	10,16
20	25,40	22,86	7,62	10,16
24	30,48	27,94	15,24	17,78
28	35,56	33,02	15,24	17,78
40	50,80	48,26	15,24	17,78

NOTE: ABOVE LAYOUT MAY CONTAIN VARIANCES. FOR A DETAILED DRAWING PLEASE CALL 1-877-277-6266 OR GO TO www.usa-assmann.com

Assmann Part Number	Contacts	Version
Basic Stocking Parts		
AR08-HZW/T-R	8	Standard
AR14-HZW/T-R	14	Standard
AR16-HZW/T-R	16	Standard
AR18-HZW/T-R	18	Standard
AR20-HZW/T-R	20	Standard
AR24-HZW/T-R	24	Standard
AR28-HZW/T-R	28	Standard
AR40-HZW/T-R	40	Standard

IC sockets, Low Cost version, pitch 2.54mm

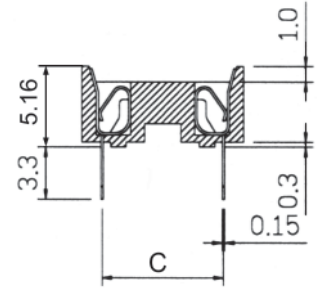
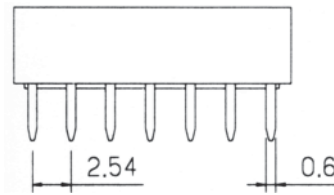
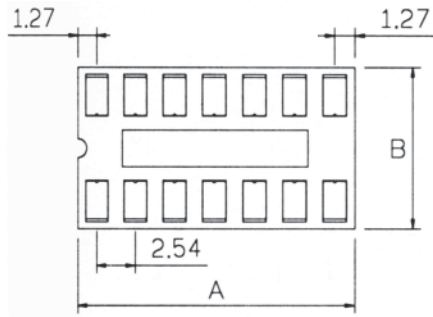
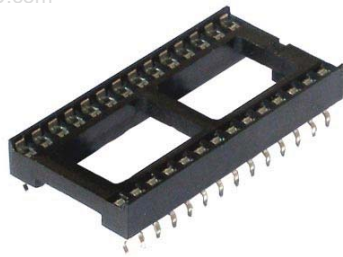
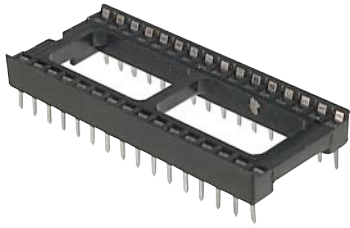

www.DataSheet4U.com

Insulator

Polyester, glass reinforced
UL 94V-0

Contacts

Phosphor bronze, tin plated

Operating temperature

-55°C to +105°C

Current rating

1A

Withstanding voltage

1000V AC (1min)

No. of Contacts	Qty per Tube	Dimensions		
		A	B	C
06	80	7.62	10.0	7.62
08	60	10.06	9.96	7.62
14	34	17.68	9.96	7.62
16	30	20.22	9.96	7.62
18	26	22.76	9.96	7.62
20	24	22.86	9.96	7.62
22	21	27.80	9.96	7.62
22*	21	27.70	12.62	10.16
24	20	30.38	17.68	15.24
24**	20	30.38	17.68	7.62
28	17	35.46	17.68	15.24
28**	17	35.46	17.68	7.62
32	15	40.50	17.68	15.24
40	12	50.70	17.68	15.24

NOTE: ABOVE LAYOUT MAY CONTAIN VARIANCES. FOR A DETAILED DRAWING PLEASE CALL 1-877-277-6266 OR GO TO www.usa-assmann.com

Assmann Part Number Basic Stocking Parts	Contacts	Version	Assmann Part Number Basic Stocking Parts	Contacts	Version	Assmann Part Number Basic Stocking Parts	Contacts	Version	Assmann Part Number Basic Stocking Parts	Contacts	Version
A06-LC-TT-R	6	Straight leg	A06-LC-TR-R	6	Retentive Leg	A06-LCG-T-R	6	Gold	A24-LC-7-TT-R	24	Pitch 7.62mm
A08-LC-TT-R	8	Straight leg	A08-LC-TR-R	8	Retentive Leg	A08-LCG-T-R	8	Gold	A28-LC-7-TT-R	28	Pitch 7.62mm
A14-LC-TT-R	14	Straight leg	A14-LC-TR-R	14	Retentive Leg	A14-LCG-T-R	14	Gold	A22-LC-T2-R	22	Width(B) 12.62mm
A16-LC-TT-R	16	Straight leg	A16-LC-TR-R	16	Retentive Leg	A16-LCG-T-R	16	Gold			
A18-LC-TT-R	18	Straight leg	A18-LC-TR-R	18	Retentive Leg	A18-LCG-T-R	18	Gold			
A20-LC-TT-R	20	Straight leg	A20-LC-TR-R	20	Retentive Leg	A20-LCG-T-R	20	Gold			
A22-LC-TT-R	22	Straight leg	A22-LC-TR-R	22	Retentive Leg	A22-LCG-T-R	22	Gold			
A24-LC-TT-R	24	Straight leg	A24-LC-TR-R	24	Retentive Leg	A24-LCG-T-R	24	Gold			
A28-LC-TT-R	28	Straight leg	A28-LC-TR-R	28	Retentive Leg	A28-LCG-T-R	28	Gold			
A32-LC-TT-R	32	Straight leg	A32-LC-TR-R	32	Retentive Leg	A32-LCG-T-R	32	Gold			
A40-LC-TT-R	40	Straight leg	A40-LC-TR-R	40	Retentive Leg	A40-LCG-T-R	40	Gold			

Chip-carrier-sockets



www.DataSheet4U.com

Insulator
PBT, UL 94V-0

Contacts
Phosphor bronze, tin plated

Current rating
1A

Insulating resistance
10000M Ω min

Withstanding voltage
1000V AC

Contact resistance
15m Ω max

Operating temperature
-40°C bis +105°C

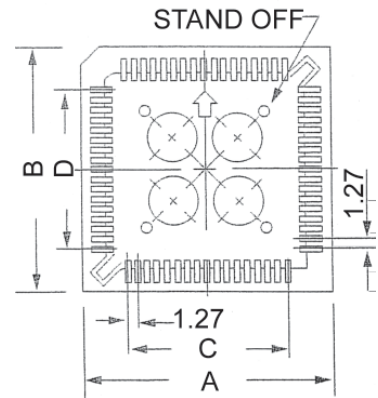
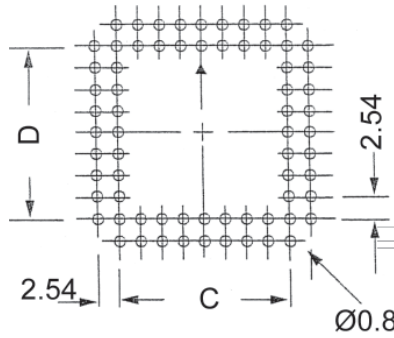
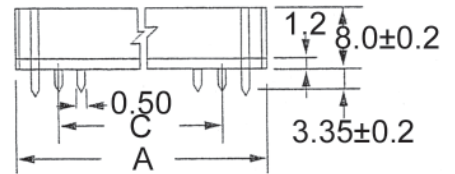

No. of Contacts	Qty per tube	Dimension			
		A	B	C	D
20	39	15,50	15,50	5,08	5,08
28	33	18,05	18,05	7,62	7,62
32	29	18,05	20,60	7,62	10,16
44	25	23,50	23,50	12,70	12,70
52	23	25,88	25,88	15,24	15,24
68	19	31,66	31,66	20,32	20,32
84	16	36,66	36,66	25,40	25,40

NOTE: ABOVE LAYOUT MAY CONTAIN VARIANCES. FOR A DETAILED DRAWING PLEASE CALL 1-877-277-6266 OR GO TO www.usa-assmann.com

Assmann Part Number Basic Stocking Parts	Contacts	Version	Assmann Part Number Basic Stocking Parts	Contacts	Version
A-CCS20-G-R	20	Gold	A-CCS20-Z-R	20	Standard Tin
A-CCS28-G-R	28	Gold	A-CCS28-Z-R	28	Standard Tin
A-CCS32-G-R	32	Gold	A-CCS32-Z-R	32	Standard Tin
A-CCS44-G-R	44	Gold	A-CCS44-Z-R	44	Standard Tin
A-CCS52-G-R	52	Gold	A-CCS52-Z-R	52	Standard Tin
A-CCS68-G-R	68	Gold	A-CCS68-Z-R	68	Standard Tin
A-CCS84-G-R	84	Gold	A-CCS84-Z-R	84	Standard Tin

Chip-carrier-sockets, SMD, Standard and Low Profile version

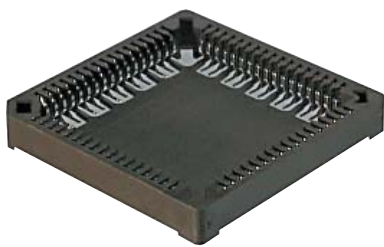

www.DataSheet4U.com

- Insulator**
PPS, UL 94V-0
- Contacts**
Phosphor bronze, tin plated
- Current rating**
1A
- Insulating resistance**
10000M Ω min
- Withstanding voltage**
1000V AC
- Contact resistance**
15m Ω max
- Operating temperature**
-40°C to +105°C

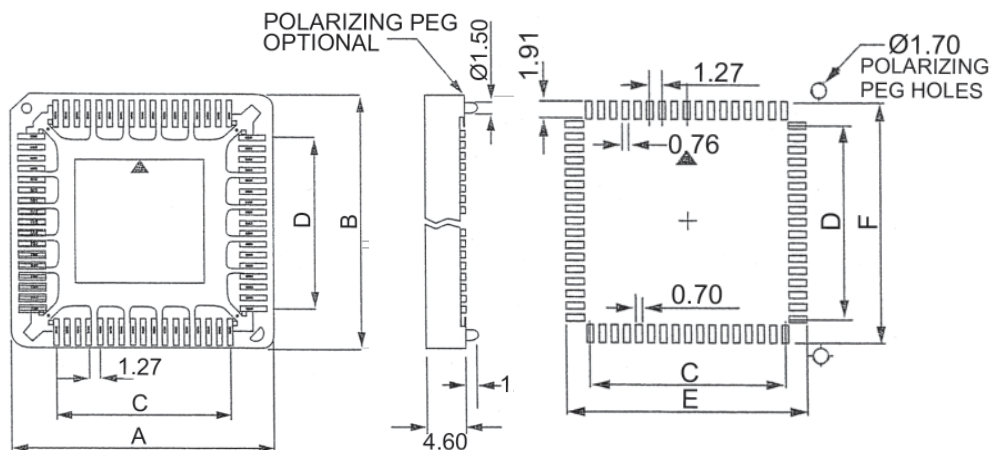

No. of Contacts	Quantity in tube	Dimension					
		A	B	C	D	E	F
20	39	15,34	15,34	5,08	5,08	10,03	10,03
28	33	17,85	17,85	7,62	7,62	12,57	12,57
32	29	17,85	20,42	7,62	10,16	12,57	15,11
44	26	23,07	23,07	12,70	12,70	17,65	17,65
52	23	25,50	25,50	15,24	15,24	20,19	20,19
68	19	31,00	31,00	20,32	20,32	25,27	25,27
84	16	36,10	36,10	25,40	25,40	30,35	30,35

NOTE: ABOVE LAYOUT MAY CONTAIN VARIANCES. FOR A DETAILED DRAWING PLEASE CALL 1-877-277-6266 OR GO TO www.usa-assmann.com

Assmann Part Number Basic Stocking Parts	Contacts	Version	Type	Assmann Part Number Basic Stocking Parts	Contacts	Version	Type	Profile
A-CCS20-Z-SM-R	20	Tin	SMD w/o polarizing peg	A-CCS20-Z-SM-LP-R	20	Standard Tin	SMD w/o polarizing peg	Low Profile
A-CCS28-Z-SM-R	28	Tin	SMD w/o polarizing peg	A-CCS28-Z-SM-LP-R	28	Standard Tin	SMD w/o polarizing peg	Low Profile
A-CCS32-Z-SM-R	32	Tin	SMD w/o polarizing peg	A-CCS32-Z-SM-LP-R	32	Standard Tin	SMD w/o polarizing peg	Low Profile
A-CCS44-Z-SM-R	44	Tin	SMD w/o polarizing peg	A-CCS44-Z-SM-LP-R	44	Standard Tin	SMD w/o polarizing peg	Low Profile
A-CCS52-Z-SM-R	52	Tin	SMD w/o polarizing peg	A-CCS52-Z-SM-LP-R	52	Standard Tin	SMD w/o polarizing peg	Low Profile
A-CCS68-Z-SM-R	68	Tin	SMD w/o polarizing peg	A-CCS68-Z-SM-LP-R	68	Standard Tin	SMD w/o polarizing peg	Low Profile
A-CCS84-Z-SM-R	84	Tin	SMD w/o polarizing peg	A-CCS84-Z-SM-LP-R	84	Standard Tin	SMD w/o polarizing peg	Low Profile

Socket, with machined contacts 1-row

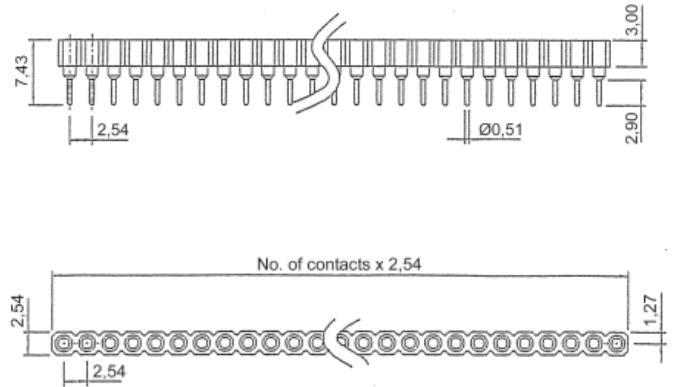

www.DataSheet4U.com

- Insulator**
Polyester GV, UL 94V-0
- Pin**
Brass, machined
- Clip**
gold flash over nickel
- Tensile strength**
1000V rms
- Current rating**
3A
- Operating temperature**
-65°C to +150°C

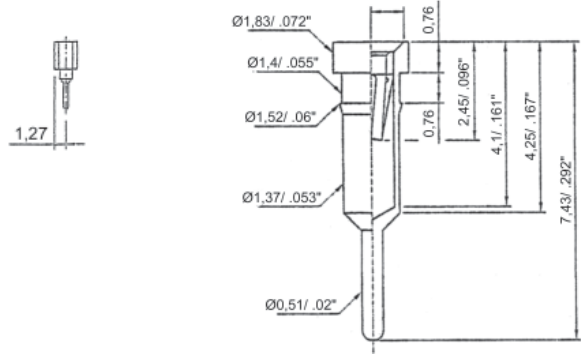

NOTE: ABOVE LAYOUT MAY CONTAIN VARIANCES. FOR A DETAILED DRAWING PLEASE CALL 1-877-277-6266 OR GO TO www.usa-assmann.com

Assmann Part Number Basic Stocking Parts	Contacts	Version	Assmann Part Number Basic Stocking Parts	Contacts	Version
AW127-02/Z-T-R	02	Tin	AW127-02/Z-T-R	02	Gold
AW127-03/Z-T-R	03	Tin	AW127-03/Z-T-R	03	Gold
AW127-04/Z-T-R	04	Tin	AW127-04/Z-T-R	04	Gold
AW127-05/Z-T-R	05	Tin	AW127-05/Z-T-R	05	Gold
.
.
.
AW127-40/Z-T-R	40	Tin	AW127-40/Z-T-R	40	Gold

Pin Header, Pitch 2.54, Single Row

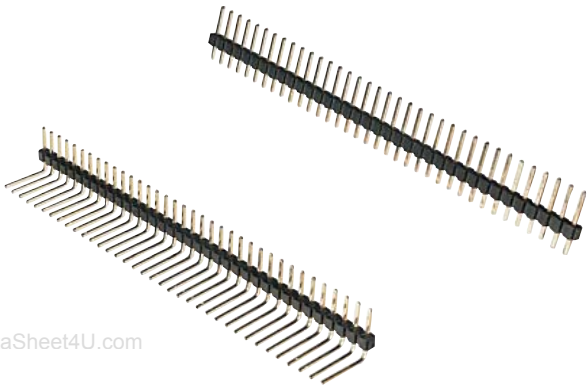

www.DataSheet4U.com

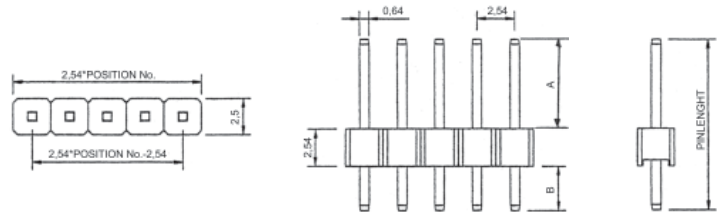

Insulator

Glass-filled thermoplastic, UL94V-0

Contact

Brass

Contact resistance

20mΩ max at 1A

Insulation resistance

5000MΩ at 500V DC

Dielectric voltage

250V AC/rms, 60Hz for 1 minute

Current rating

3A

Voltage rating

250V AC/rms, 60Hz

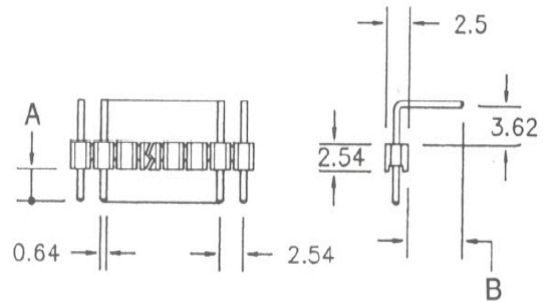

Straight Angle Version

NOTE: ABOVE LAYOUT MAY CONTAIN VARIANCES. FOR A DETAILED DRAWING PLEASE CALL 1-877-277-6266 OR GO TO www.usa-assmann.com

Assmann Part Number Basic Stocking Parts	Contacts	Version	Assmann Part Number Basic Stocking Parts	Contacts	Version	Available Ping Lengths	Part Number Pattern
AW140-11.2-G-02-R	02	Tin	AW140-11.2-G-02-R	02	Gold	9.2	AW140-9.2-Z-40-R
AW140-11.2-G-03-R	03	Tin	AW140-11.2-G-03-R	03	Gold	11.8	AW140-11.8-Z-40-R
.	12.4	AW140-12.4-Z-40-R
.	13.6	AW140-13.6-Z-40-R
.	21.1	AW140-21.1-Z-40-R
AW140-11.2-G-40-R	40	Tin	AW140-11.2-G-40-R	40	Gold		

Right Angle Version

Assmann Part Number Basic Stocking Parts	Contacts	Version	Assmann Part Number Basic Stocking Parts	Contacts	Version	Available Ping Lengths	Part Number Pattern	Dimension A	Dimension B
AW140A-13Z02-R	02	Tin	AW140A-13G02-R	02	Gold	13 = .100"	AW140A-13Z40-R	5.720mm	2.400mm
AW140A-13Z03-R	03	Tin	AW140A-13G03-R	03	Gold	15 = .200"	AW140A-15Z40-R	5.720mm	4.600mm
.	21 = .401"	AW140A-21Z40-R	5.720mm	9.800mm
.				
AW140A-13Z40-R	40	Tin	AW140A-13G40-R	40	Gold				

Pin Header, Pitch 2.54, Double Row

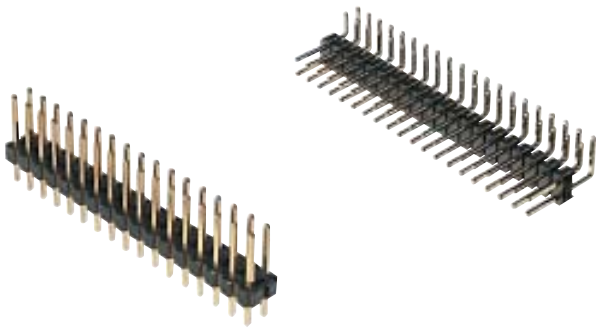

www.DataSheet4U.com

Insulator material
Polyester, UL94V-0

Current rating
3A

Contact material
Brass

Insulator resistance
5000M Ω min.

Dielectric withstanding
500V AC

Operating temperature
-40°C to +105°C

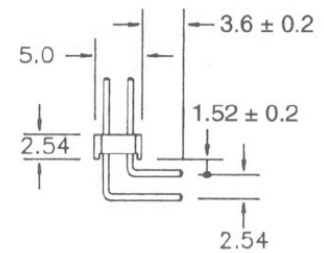
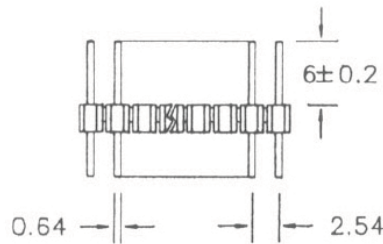
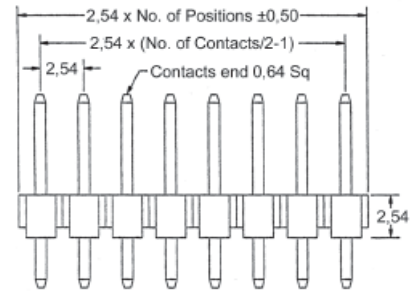
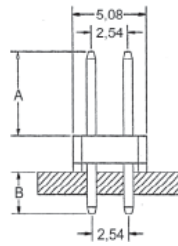

Straight Angle Version

NOTE: ABOVE LAYOUT MAY CONTAIN VARIANCES. FOR A DETAILED DRAWING PLEASE CALL 1-877-277-6266 OR GO TO www.usa-assmann.com

Assmann Part Number Basic Stocking Parts	Contacts	Version	Assmann Part Number Basic Stocking Parts	Contacts	Version	Available Ping Lengths	Part Number Pattern
AWL02-11.2-Z-R	02	Tin	AWL02-11.2-G-R	02	Gold	11.8	AWL02-11.8-G-R
AWL03-11.2-Z-R	03	Tin	AWL03-11.2-G-R	03	Gold	12.4	AWL02-12.4-G-R
.		
.		
.		
AWL80-11.2-Z-R	80	Tin	AWL80-11.2-G-R	40	Gold		

Right Angle Version

Assmann Part Number Basic Stocking Parts	Contacts	Version	Assmann Part Number Basic Stocking Parts	Contacts	Version	
AWL02-T-R	02	Tin	AWL02-G-R	02	Gold	
AWL03-T-R	03	Tin	AWL03-G-R	03	Gold	
.	
.	
.	
AWL80-T-R	80	Tin	AWL80-G-R	80	Gold	

Plugs for shorting and addressing, Pitch 2.54mm

AKSNT

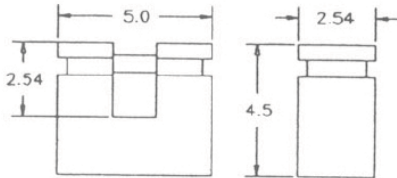

AKSPLT

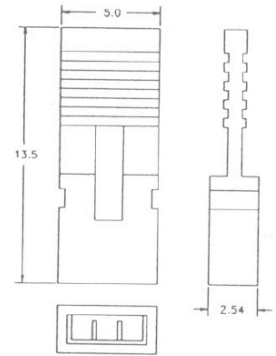
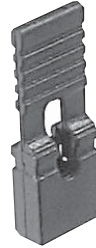

AKSCT

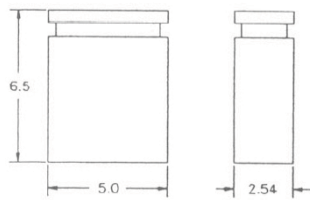

AKSPT

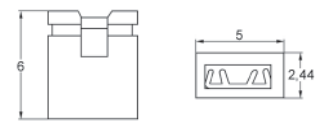
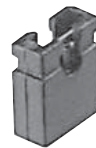

NOTE: ABOVE LAYOUT MAY CONTAIN VARIANCES. FOR A DETAILED DRAWING PLEASE CALL 1-877-277-6266 OR GO TO www.usa-assmann.com

Assmann Part Number Basic Stocking Parts	Contact	Version	Color	Plating	Color Options	Code
AKSNT-Z-BLK-R	Tin	Low Profile	Black	Gold Flash	Blue	BLU (Change for BLK)
AKSNT-G-BLK-30-R	Gold	Low Profile	Black	30u*	Red	RED (Change for BLK)
AKSNT-G-BLK-50-R	Gold	Low Profile	Black	50u*		
AKSCT-Z-BLK-R	Tin	Closed housing	Black	Gold Flash		
AKSCT-G-BLK-30-R	Gold	Closed housing	Black	30u*		
AKSCT-G-BLK-50-R	Gold	Closed housing	Black	50u*		
AKSPLT-Z-BLK-R	Tin	With removal grip	Black	Gold Flash		
AKSPLT-G-BLK-30-R	Gold	With removal grip	Black	30u*		
AKSPLT-G-BLK-50-R	Gold	With removal grip	Black	50u*		
AKSPT-Z-BLK-R	Tin	With test slot	Black	Gold Flash		
AKSPT-G-BLK-30-R	Gold	With test slot	Black	30u*		
AKSPT-G-BLK-50-R	Gold	With test slot	Black	50u*		