

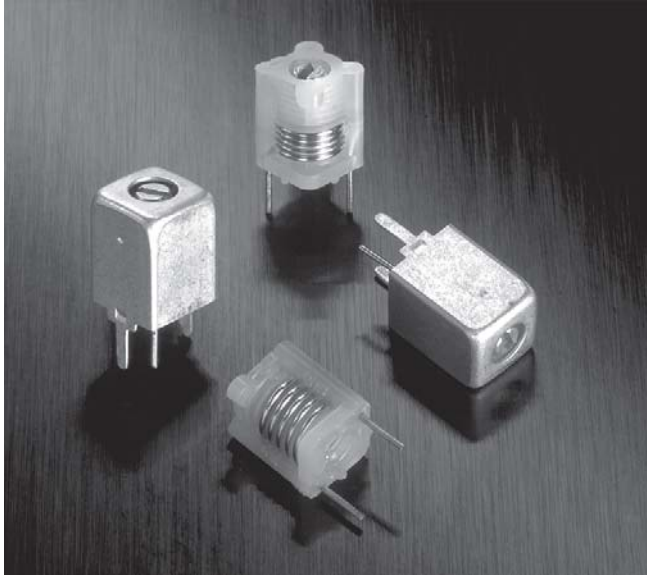

5 mm Tunable Inductor - 164, 165 Series



Coilcraft tunable inductors provide the compactness of a 5 mm coil and the low drift reliability of an insert molded coil.

Standard inductance values range from 9 nH to over 280 nH.

The windings of these economical coils are precision molded into a single piece of polypropylene/nylon/PET for mechanical and electrical stability. Optional plated brass shield cans with solderable tabs provide integral shielding and additional mounting stability.

These parts can be ordered without cores for use as fixed inductors.

Coilcraft's **Designer's Kit M305** contains samples of all standard values. To order, please contact Coilcraft or purchase on-line at <http://order.coilcraft.com>.



Unshielded Styles

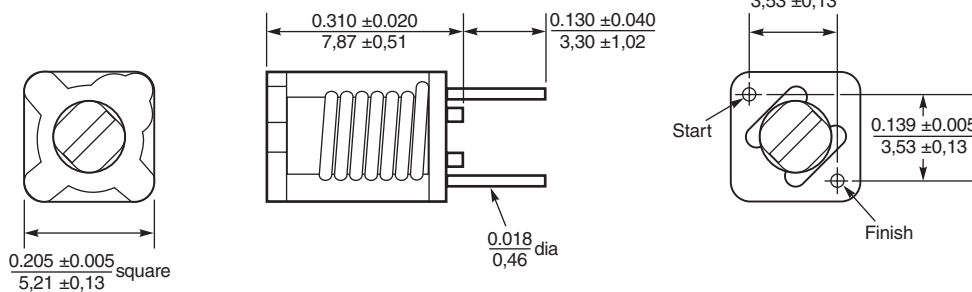

Shielded Styles

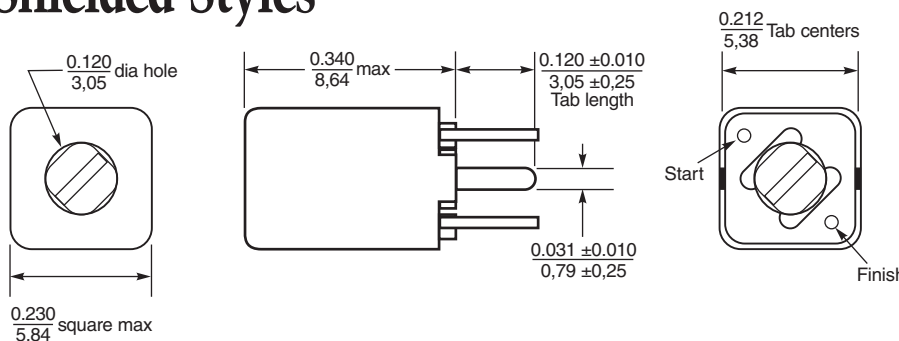

Recommended Board Layout

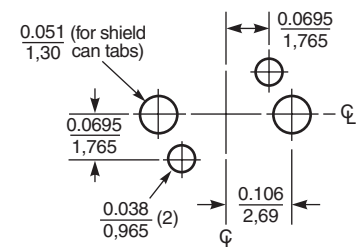

Terminations: Leads: Tin-silver over copper
Shield can tabs: Tin silver over nickel over brass

	Unshielded	With shield can
Weight: 164 series	0.16 – 0.31 g	0.45 – 0.60 g
165 series	0.15 – 0.25 g	0.43 – 0.54 g



Specifications subject to change without notice.
Please check our website for latest information.

Document 110-1 Revised 08/15/05



5 mm Tunable Inductor – Unshielded

Part number ¹	Color	Turns	No core		at L max ³		at L min ⁴		Freq (MHz)	No core SRF min (MHz)	Irms ⁶ (A)
			L (nH) ²	Q min ⁵	L (nH) ²	Q min ⁵	L (nH) ²	Q min ⁵			
164-01A06L	Brown	1 1/2	19	145	19	145	16	112	150	2000	7.2
164-02A06L	Red	2 1/2	34	138	34	138	26	96	150	1260	5.1
164-03A06L	Orange	3 1/2	55	130	55	130	38	79	150	960	4.4
164-04A06L	Yellow	4 1/2	77	119	77	119	52	72	150	850	3.7
164-05A06L	Green	5 1/2	101	108	99	86	65	64	150	770	3.6
164-06A06L	Blue	6 1/2	128	107	126	75	83	60	100	730	3.3
164-07A06L	Violet	7 1/2	156	106	150	68	97	57	100	640	3.1
164-08A06L	Gray	8 1/2	183	100	178	62	112	53	100	570	2.9
164-09A06L	White	9 1/2	216	100	190	62	131	53	100	540	2.7
164-10A06L	Black	10 1/2	248	92	223	55	148	51	100	490	2.5
164-11A06L	Brown	11 1/2	281	92	246	55	170	51	100	360	2.3
165-00A06L	Black	1/2	9	147	9	147	9	131	150	6000	8.1
165-01A06L	Brown	1 1/2	18	145	18	145	15	112	150	2850	6.5
165-02A06L	Red	2 1/2	32	143	32	143	25	92	150	1860	4.9
165-03A06L	Orange	3 1/2	48	138	45	135	33	84	150	1410	4.2
165-04A06L	Yellow	4 1/2	64	133	60	114	43	76	150	1130	3.8
165-05A06L	Green	5 1/2	83	125	78	110	54	73	150	820	3.6
165-06A06L	Blue	6 1/2	103	120	90	94	68	70	150	800	3.4
165-07A06L	Violet	7 1/2	122	115	105	92	79	69	150	770	3.1

Notes:

- To order fixed inductance parts without cores, eliminate the "A06", e.g. 164-01.
 - Inductance measured on Agilent/HP 4286A Impedance Analyzer with 16092A Spring Clip Fixture.
 - L max measured with core halfway out top of form.
 - L min measured with core centered in winding.
 - Q measured on Agilent/HP 4286A with 16092A fixture, direct connect to Agilent/HP 4342A Q-Meter and Meguro MQ-171 Q-Meter with 0.5" bus bars.
 - Average current for a 15°C rise above 25°C ambient.
 - Core: Aluminum 0.187" (4.75 mm) long.
 - Operating temperature range -40°C to +85°C.
 - Electrical specifications 25°C.
- See Qualification Standards section for environmental and test data.

Typical Q vs Frequency

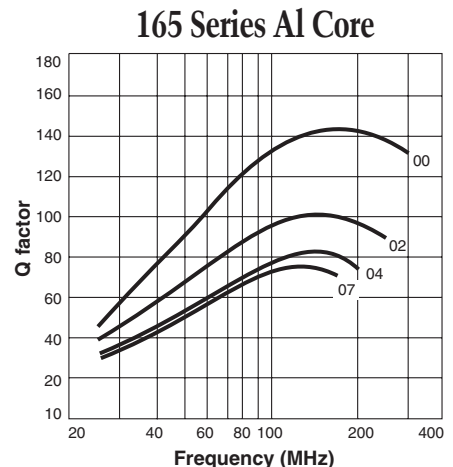
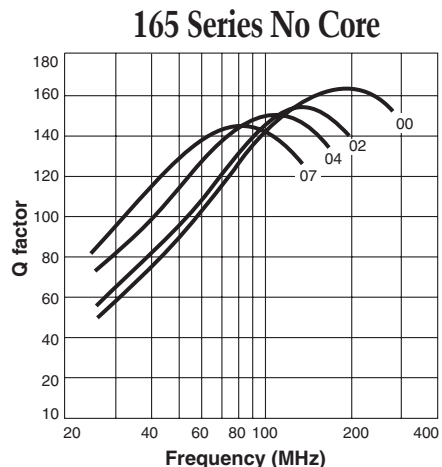
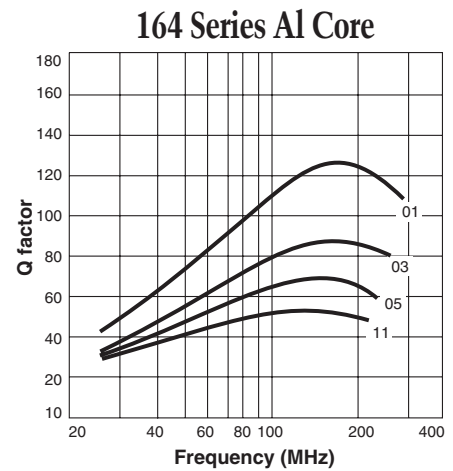
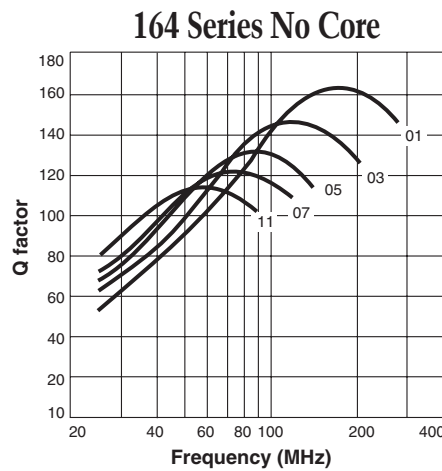

S-Parameter files

ON OUR WEB SITE OR CD

SPICE models

ON OUR WEB SITE OR CD

COILCRAFT ACCURATE REPEATABLE MEASUREMENTS
PRECISION TEST FIXTURES
 SEE INDEX



Specifications subject to change without notice. Please check our website for latest information.

Document 110-2 Revised 03/18/05



5 mm Tunable Inductor – Shielded

TRITUNER 3 TOOLS IN 1
SEE INDEX
TUNING WRENCH

Part number ¹	Color	Turns	No core		at L max ³		at L min ⁴		Freq (MHz)	No core SRF min (MHz)	Irms ⁶ (A)
			L (nH) ²	Q min ⁵	L (nH) ²	Q min ⁵	L (nH) ²	Q min ⁵			
164-01A06SL	Brown	1 1/2	16	124	16	124	14	106	150	2100	7.2
164-02A06SL	Red	2 1/2	27	108	27	108	22	89	150	1300	5.1
164-03A06SL	Orange	3 1/2	41	92	41	92	32	72	150	1100	4.4
164-04A06SL	Yellow	4 1/2	56	86	56	84	43	66	150	940	3.7
164-05A06SL	Green	5 1/2	71	80	71	79	53	60	150	980	3.6
164-06A06SL	Blue	6 1/2	88	79	80	77	65	59	150	800	3.3
164-07A06SL	Violet	7 1/2	105	75	101	70	76	54	100	750	3.1
164-08A06SL	Gray	8 1/2	122	74	117	64	87	54	100	580	2.9
164-09A06SL	White	9 1/2	141	71	134	62	100	53	100	550	2.7
164-10A06SL	Black	10 1/2	160	69	150	60	113	51	100	490	2.5
164-11A06SL	Brown	11 1/2	179	69	164	60	127	51	100	400	2.3
165-00A06SL	Black	1/2	9	138	9	138	9	121	150	6000	8.1
165-01A06SL	Brown	1 1/2	16	124	16	124	14	104	150	2570	6.5
165-02A06SL	Red	2 1/2	25	110	25	110	21	87	150	1670	4.9
165-03A06SL	Orange	3 1/2	35	104	33	102	28	78	150	1230	4.2
165-04A06SL	Yellow	4 1/2	46	97	41	90	35	69	150	1150	3.8
165-05A06SL	Green	5 1/2	57	92	50	82	43	67	150	820	3.6
165-06A06SL	Blue	6 1/2	68	86	59	75	52	65	150	800	3.4
165-07A06SL	Violet	7 1/2	80	85	70	74	60	64	150	770	3.1

Notes:

- To order fixed inductance parts without cores, eliminate the "A06", e.g. 164-01S.
 - Inductance measured on Agilent/HP 4286A Impedance Analyzer with 16092A Spring Clip Fixture.
 - L max measured with core halfway out top of form.
 - L min measured with core centered in winding.
 - Q measured on Agilent/HP 4286A with 16092A fixture, direct connect to Agilent/HP 4342A Q-Meter and Meguro MQ-171 Q-Meter with 0.5" bus bars.
 - Average current for a 15°C rise above 25°C ambient.
 - Core: Aluminum 0.187" (4.75 mm) long.
 - Operating temperature range -40°C to +85°C.
 - Electrical specifications 25°C.
- See Qualification Standards section for environmental and test data.

Typical Q vs Frequency

164 Series No Core

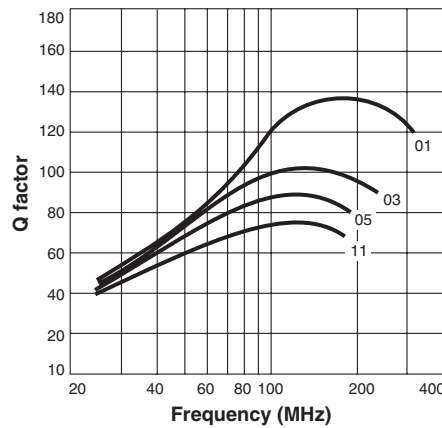

164 Series Al Core

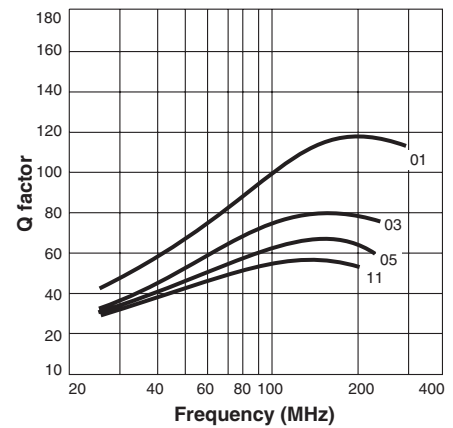

165 Series No Core

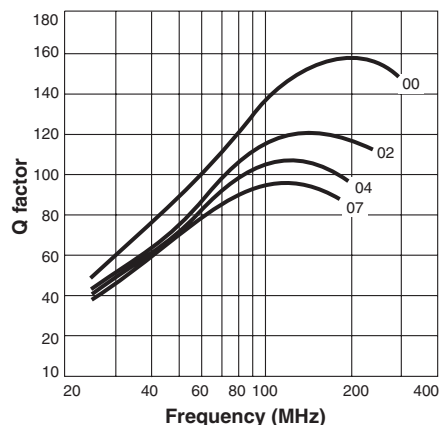

165 Series Al Core

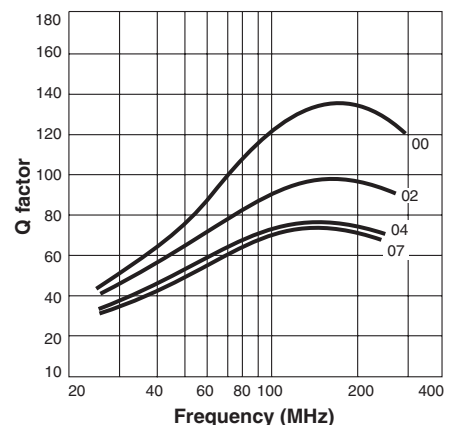

S-Parameter files

ON OUR WEB SITE OR CD

SPICE models

ON OUR WEB SITE OR CD

COILCRAFT ACCURATE REPEATABLE MEASUREMENTS
PRECISION TEST FIXTURES
SEE INDEX



Specifications subject to change without notice. Please check our website for latest information.

Document 110-3 Revised 03/18/05