

3SE International Limit Switches

Position Switches

3SE2 100 to 3SE3 170 / 3SE2 303 / 3SE2 404
Metal enclosure and open type

Features

- UL Listed, CSA Certified, CE. Meets or exceeds most local, national and international standards.
- Standard (40 mm) or Wide (56 mm) die-cast aluminum housing. Offers increased wiring space, additional cable

entry options and corrosion resistant housing

- Standard (40 mm) offerings can accommodate both U.S. 29.4 [1.16] × 59.5 [2.34] and DIN 30 [1.18] × 60 [2.36] mounting dimensions

- Nine field interchangeable operating heads (12 variations). Interchangeable on both the standard (40 mm) and wide (56 mm) styles. Reduces inventory and inventory costs
- Field replaceable, electrically isolated, double bridge

contacts. Provides electrical flexibility and ease of maintenance

- Direct opening action (positive opening) of the NC contact
- NEMA A600, Q600 contact ratings

Application

The function of position switches (limit switches) is to produce electrical signals corresponding to the positions of moving machinery.

The units are suitable for use in virtually any climate.

Specifications

IEC 60 947-5-1.

The 3SE2 100 and 3SE2 120 position switches correspond to Swiss regulations (SUVA). The following actuator types have been approved:

- Plunger – B
- Overtravel plunger – C
- Roller plunger – D
- Roller lever – E
- Angular roller lever – F
- Roller crank – GW

In addition, the open-type 3SE3 position switches and the 3SE3 switch inserts are also permitted.

Safety position switches

The 3SE position switches with metal enclosures and snap-action contacts as well as devices with slow-action contacts can be used as safety position switches in control systems conforming to EN 60 204-1, or IEC 60 204-1.

Construction

3SE position switches are available in die-cast standard (40 mm) or wide (50 mm) aluminum enclosures or as open-type units.

The 3SE2 120/3SE3 170 position switches with standard enclosure, overtravel plunger, roller plunger, rod and roller crank actuators, conform to EN 50 041. These specifications define the most important mounting dimensions, operating points, enclosure types and actuator types.

Position switches have one or three cable entries. The cable entry has a 1/2"-NPT (3SE3) or M20 × 1.5 (3SE2) threaded metal wire opening. (see also [Accessories, Page 13/97](#))

Actuators

All actuators can be retro-fitted or exchanged for another version. They can also be repositioned every 90° so that the switches can be operated from any of the four sides.

- The position switches with roller lever are approached perpendicular to the plunger axis and position switches with angular roller lever are approached in parallel with the plunger axis.
- The roller crank actuators, adjustable-length roller crank actuators and rod actuators can be operated from both sides and be positioned from 10° to 10° on the actuating spindle. The rollers of the actuators are made from wear resistant plastic.

- The wobble spring can be approached from any direction.
- The forked lever actuator has two defined switching positions. The actuating element causes changeover from one position to the other. This actuator is suitable for two-channel operation.

The open-type 3SE position switches are available exclusively with a plunger actuator.

Important:

The 3SE position switches with metal enclosure are not permitted to be used as stops.

Contacts

The position switches (limit switches) are available with snap-action contacts, slow-action contacts or slow-action make-before-break contacts.

The 3SE position switches with a metal enclosure are available with 2, 3 or 4 contacts.

The movable normally closed and normally open switch contacts are electrically isolated from each other and are suitable for switching voltages of different potentials.

Contact reliability

The movable switch contacts are double moving contacts. This increases the contact reliability even when the switch has to be operated with low voltages and currents, e. g. DC 5 V/1 mA.

The switching point of the snap action contacts is independent of the switching speed.

The contact chamber is covered to prevent ingress of foreign bodies.

Principle of operation

Positive opening →

The opening contacts of the switch are forced open mechanically, positively-driven and reliably by the plunger (positive-opening).

In order to ensure this positive opening, the position switch must be actuated in such a way that the nominal travel ([Pages 13/100 to 13/112](#)) and angle for the positive opening are substantially exceeded.

Position switches that display this symbol are suitable for use in safety applications.

3SE International Limit Switches

Position Switches

3SE2 100 to 3SE3 170 / 3SE2 303 / 3SE2 404
Metal enclosure and open type, 40 and 56 mm width

Technical data

<ul style="list-style-type: none"> • rated voltage • continuous current • switching capacity - for 3SE...-8. 	AC 600 V 10 A Heavy Duty, A 600/Q 600 Heavy Duty, A 300/Q 30																																																
Rated insulation voltage U_i	500 V																																																
Pollution degree	Class 3																																																
Short circuit protection ¹⁾ , DIAZED-fuse links	Utilization category gL/gG 6 A, quick response characteristic 10 A																																																
Rated operational voltage U_e	AC 500 V, over 300 V only for equal potential (3SE21.0-and 3SE3170-8..00) AC 500 V, over AC 380 V only for equal potential																																																
Conventional free-air thermal current I_{th}	10 A																																																
Rated operational current I_e ⁴⁾	<table border="1"> <thead> <tr> <th colspan="3">AC 40 to 60 Hz</th> <th colspan="3">DC</th> </tr> <tr> <th>U_e</th> <th>I_e / AC-12</th> <th>I_e / AC-15</th> <th>U_e</th> <th>I_e / DC-12</th> <th>I_e / DC-13</th> </tr> <tr> <th>V</th> <th>A</th> <th>A</th> <th>V</th> <th>A</th> <th>A</th> </tr> </thead> <tbody> <tr> <td>24</td> <td>10</td> <td>10</td> <td>24</td> <td>10</td> <td>10</td> </tr> <tr> <td>125</td> <td>10</td> <td>10</td> <td>48</td> <td>6</td> <td>4</td> </tr> <tr> <td>230</td> <td>10</td> <td>6</td> <td>110</td> <td>4</td> <td>1</td> </tr> <tr> <td>400</td> <td>10</td> <td>4</td> <td>220</td> <td>1</td> <td>0.4²⁾</td> </tr> <tr> <td>500</td> <td>10</td> <td>3</td> <td>440</td> <td>0.5</td> <td>0.2³⁾</td> </tr> </tbody> </table>	AC 40 to 60 Hz			DC			U_e	I_e / AC-12	I_e / AC-15	U_e	I_e / DC-12	I_e / DC-13	V	A	A	V	A	A	24	10	10	24	10	10	125	10	10	48	6	4	230	10	6	110	4	1	400	10	4	220	1	0.4 ²⁾	500	10	3	440	0.5	0.2 ³⁾
AC 40 to 60 Hz			DC																																														
U_e	I_e / AC-12	I_e / AC-15	U_e	I_e / DC-12	I_e / DC-13																																												
V	A	A	V	A	A																																												
24	10	10	24	10	10																																												
125	10	10	48	6	4																																												
230	10	6	110	4	1																																												
400	10	4	220	1	0.4 ²⁾																																												
500	10	3	440	0.5	0.2 ³⁾																																												
Mechanical endurance	30×10^6 operating cycles (15×10^6 for 3SE3 2.0-8.)																																																
Electrical endurance	10×10^6 operating cycles with 3RH11, 3RT10 16, 3RT10 17, 3RT10 24 to 3RT10 26 (3TH4, 3TF40 to 3TF43) contactors 0.5×10^6 operating cycles when interrupting I_e / AC-15 at 230 V With DC the contact endurance depends not only on the breaking current but also on the voltage, the circuit inductance and the speed of switching. No generally valid information can be given.																																																
<ul style="list-style-type: none"> • for AC-15 duty • for DC-13 duty 																																																	
Operating frequency	6×10^3 operating cycles per hour with 3RH11, 3RT10 16, 3RT10 17, 3RT10 24 to 3RT10 26 (3TH4, 3TF40 to 3TF43) contactors																																																
Operating accuracy	0.05 mm for repeated switching, measured at the plunger of the switch block.																																																
Operating point	With snap-action contacts independent of contact wear constant throughout the life of the switch																																																
Ambient temperature	-30 to +85 °C (-22 to +185°F)																																																
Degree of protection DIN VDE 0470 and IEC 60 529																																																	
<ul style="list-style-type: none"> • with metal enclosure • open-type • electrical plug and socket connection 	IP 67 IP 20 (terminals), IP 40 (switching chamber) IP 65																																																
Enclosure cable entry	1 x 1/2"-NPT (3SE3); 1 x M 20 x 1.5 (3SE212) or 3 x M20 x 1.5 (3SE2100, 2303, 2404)																																																
Conductor cross-sections																																																	
<ul style="list-style-type: none"> • solid • finely stranded with end sleeve 	2 x 2.5 mm ² (2 x 14 AWG) 2 x 1.5 mm ² (2 x 16 AWG)																																																
Installation angle	Any																																																
Enclosure material	Metal (GD – AISi 12)																																																
Protective conductor terminal	M 3.5 inside enclosure																																																

1) Without any welding acc. to DIN VDE 0660 Part 200.

2) 3SE21.0 - and 3SE3170 - 8..00: 0.27A

3) 3SE21.0 - and 3SE3170 - 8..00: 0.10A

4) Refer to Section 19, General Information for NEMA Control and Circuit Ratings.







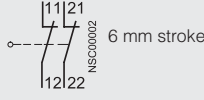

3SE International Limit Switches

Position Switches

3SE2 100 to 3SE3 170
Metal enclosure, 40 and 56 mm width

Selection and ordering data

2 contacts · Moving double break contacts · IP 67 degree of protection · EN 50 041

40 mm wide	56 mm wide ²⁾	Actuator design to EN 50 041	Enclosure width	3SE. position switches with 2 slow-action contacts	3SE. position switches with 2 slow-action contacts	Weight approx.		
				with 2 slow-action contacts	with 2 slow-action contacts			
				 6 mm stroke Identification number 11 acc. to EN 50 013, switch block 3SE3 000-0A	 6 mm stroke Identification number 02 acc. to EN 50 013, switch block 3SE3 000-6A			
				Order No.	List Price \$	Order No.	List Price \$	kg
				1 unit	1 unit	1 unit	1 unit	
	Actuator ¹⁾		mm					
	Plunger (3SX3100)	–	40 56	→ 3SE□ 1□0-0B → 3SE2 100-0B	50.00 50.00	→ 3SE□ 1□0-6B → 3SE2 100-6B	50.00 50.00	0.190 0.220
	Overtravel plunger (3SX3106)	B	40 56	→ 3SE□ 1□0-0C → 3SE2 100-0C	67.00 67.00	→ 3SE□ 1□0-6C → 3SE2 100-6C	67.00 67.00	0.230 0.258
	Roller plunger (3SX3107)	C	40 56	→ 3SE□ 1□0-0D → 3SE2 100-0D	74.00 74.00	→ 3SE□ 1□0-6D → 3SE2 100-6D	74.00 74.00	0.250 0.280
	Roller lever Actuator made of molded plastic (3SX3102)	–	40 56	→ 3SE□ 1□0-0E → 3SE2 100-0E	63.00 63.00	→ 3SE□ 1□0-6E → 3SE2 100-6E	63.00 63.00	0.210 0.240
	Angular roller lever Actuator made of molded plastic (3SX3104)	–	40 56	→ 3SE□ 1□0-0F → 3SE2 100-0F	60.00 60.00	→ 3SE□ 1□0-6F → 3SE2 100-6F	60.00 60.00	0.225 0.240
	Roller crank • finely adjustable from 10° to 10° (3SX3211 + 3SX3212)	A	40 56	→ 3SE□ 1□0-0GW → 3SE2 100-0GW	71.00 71.00	→ 3SE□ 1□0-6GW → 3SE2 100-6GW	71.00 71.00	0.305 0.335
	• adjustable length, finely – adjustable from 10° to 10° (3SX3211 + 3SX3213)		40 56	3SE□ 1□0-0UW 3SE2 100-0UW	87.00 87.00	3SE□ 1□0-6UW 3SE2 100-6UW	87.00 87.00	0.315 0.333
	Rod actuator finely adjustable from 10° to 10°	D						
	• Molded plastic rod (3SX3211 + 3SX3215)		40 56	3SE□ 1□0-0WW 3SE2 100-0WW	82.00 82.00	3SE□ 1□0-6WW 3SE2 100-6WW	82.00 83.00	0.315 0.348
	• Aluminum rod (3SX3211 + 3SX3214)		40 56	3SE□ 1□0-0VW 3SE2 100-0VW	83.00 83.00	3SE□ 1□0-6VW 3SE2 100-6VW	83.00 83.00	0.321 0.354
	Switch body with switch block without actuator		40 56	3SE□ 1□0-0A 3SE2 100-0A	44.00 44.00	3SE□ 1□0-6A 3SE2 100-6A	44.00 44.00	0.175 0.203

Order No. suffix

- with metric connecting thread M 20 × 1.5
I.E. 3SE□1 □0
- with 1/2" - NPT connecting thread
I.E. 3SE□1 □0

2.2

3.7

2.2

3.7

For operation, operating speed and travel, see Pages 13/100 to 13/105.

→ Positive opening acc. to IEC 60 947-5-1, Appendix K, and DIN VDE 0660 Part 200.

1) The actuator heads can be subsequently exchanged (see Page 13/95).
2) For conduit thread adaptors see page 13/97.









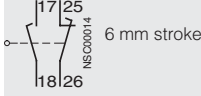

3SE International Limit Switches

Position Switches

3SE2 100 to 3SE3 170
Metal enclosure, 40 and 56 mm width

Selection and ordering data

2 contacts · Moving double break contacts · IP 67 degree of protection · EN 50 041

40 mm wide	56 mm wide ²⁾	Actuator design to EN 50 041	Enclosure width	3SE. position switches with 2 slow-action contacts	3SE. position switches with 2 slow-action make before-break contacts	Weight approx.
				 <p>6 mm stroke NSC00003</p> <p>Identification number 20 acc. to EN 50 013, switch block 3SE3 000-7A</p>	 <p>6 mm stroke NSC00014</p> <p>Identification number 11 acc. to EN 50 013, switch block 3SE3 000-3A</p>	
Order No.	List Price \$	Order No.	List Price \$	kg		
Actuator ¹⁾	mm	Order No.	List Price \$	kg		
 NSC00096	–	40	3SE□ 1□0-7B 50.00	→ 3SE□ 1□0-3B 50.00	0.195	
		56	3SE2 100-7B 50.00	→ 3SE2 100-3B 50.00	0.220	
 NSC00097	B	40	3SE□ 1□0-7C 67.00	→ 3SE□ 1□0-3C 67.00	0.230	
		56	3SE2 100-7C 67.00	→ 3SE2 100-3C 67.00	0.259	
 NSC 00088	C	40	3SE□ 1□0-7D 74.00	→ 3SE□ 1□0-3D 74.00	0.252	
		56	3SE2 100-7D 74.00	→ 3SE2 100-3D 74.00	0.277	
 ISC 00089	–	40	3SE□ 1□0-7E 63.00	→ 3SE□ 1□0-3E 63.00	0.209	
		56	3SE2 100-7E 63.00	→ 3SE2 100-3E 63.00	0.239	
 NSC00093	–	40	3SE□ 1□0-7F 60.00	→ 3SE□ 1□0-3F 60.00	0.220	
		56	3SE2 100-7F 60.00	→ 3SE2 100-3F 60.00	0.236	
 NSC 00094	A	40	3SE□ 1□0-7GW 75.00	→ 3SE□ 1□0-3GW 71.00	0.305	
		56	3SE2 100-7GW 71.00	→ 3SE2 100-3GW 71.00	0.328	
		40	3SE□ 1□0-7UW 87.00	3SE□ 1□0-3UW 87.00	0.315	
		56	3SE2 100-7UW 87.00	3SE2 100-3UW 87.00	0.336	
 NSC 00010	D	40	3SE□ 1□0-7WW 82.00	3SE□ 1□0-3WW 82.00	0.190	
		56	3SE2 100-7WW 83.00	3SE2 100-3WW 83.00	0.200	
		40	3SE□ 1□0-7VW 83.00	3SE□ 1□0-3VW 83.00	0.190	
		56	3SE2 100-7VW 83.00	3SE2 100-3VW 83.00	0.200	
		40	3SE□ 1□0-7A 44.00	3SE□ 1□0-3A 44.00	0.175	
		56	3SE2 100-7A 44.00	3SE2 100-3A 44.00	0.203	

Order No. suffix

- with metric connecting thread M 20 × 1.5
I.E. 3SE□1 □0
- with 1/2" - NPT connecting thread
I.E. 3SE□1 □0

2 . 2
3 . 7

2 . 2
3 . 7

For operation, operating speed and travel, see Pages 13/100 to 13/105.

→ Positive opening acc. to IEC 60 947-5-1, Appendix K, and DIN VDE 0660 Part 200.













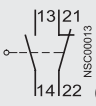



1) The actuator heads can be subsequently exchanged (see Page 13/95).
2) For conduit thread adaptors see page 13/97.

3SE International Limit Switches Position Switches

3SE2120 Specials
Metal enclosure, 40 and 56mm width

Selection and ordering data

2 contacts · Moving double break contacts · IP 67 degree of protection · EN 50 041

40 mm wide	56 mm wide ²⁾	Actuator design to EN 50 041	Enclosure width	3SE. position switches with 2 snap-action contacts	3SE3 position switches with 2 snap-action contacts	Weight approx.		
				 6 mm stroke Identification number 11 acc. to EN 50 013, switch block 3SE3 000-1A ²⁾	 6 mm stroke Identification number 02 acc. to EN 50 013 switch block 3SE3 000-8AV00 ²⁾			
				Order No.	List Price \$	Order No.	List Price \$	
					1 unit		1 unit	kg
	Actuator ¹⁾		mm					
	Plunger (3SX3100)	–	40 56	→ 3SE□ 1□0-1B → 3SE2 100-1B	50.00 50.00	→ 3SE□ 1□0-8BV00 → 3SE2 100-8BV00	50.00 50.00	0.190 0.225
	Overtravel plunger (3SX3106)	B	40 56	→ 3SE□ 1□0-1C → 3SE2 100-1C	67.00 67.00	→ 3SE□ 1□0-8CV00 → 3SE2 100-8CV00	67.00 67.00	0.230 0.260
	Roller plunger (3SX3107)	C	40 56	→ 3SE□ 1□0-1D → 3SE2 100-1D	74.00 74.00	→ 3SE□ 1□0-8DV00 → 3SE2 100-8DV00	74.00 74.00	0.255 0.279
	Roller lever Actuator made of molded plastic (3SX3102)	–	40 56	→ 3SE□ 1□0-1E → 3SE2 100-1E	63.00 63.00	→ 3SE□ 1□0-8EV00 → 3SE2 100-8EV00	63.00 63.00	0.210 0.239
	Angular roller lever Actuator made of molded plastic (3SX3104)	–	40 56	→ 3SE□ 1□0-1F → 3SE2 100-1F	60.00 60.00	→ 3SE□ 1□0-8FV00 → 3SE2 100-8FV00	60.00 60.00	0.225 0.242
	Roller crank • finely adjustable from 10° to 10° (3SX3211 + 3SX3212)	A	40 56	→ 3SE□ 1□0-1GW → 3SE2 100-1GW	71.00 71.00	→ 3SE□ 1□0-8GW00 → 3SE2 100-8GW00	71.00 71.00	0.305 0.331
	• adjustable length, finely adjustable from 10° to 10° (3SX3211 + 3SX3213)	–	40 56	3SE□ 1□0-1UW 3SE2 100-1UW	87.00 87.00	3SE□ 1□0-8UW00 3SE2 100-8UW00	87.00 87.00	0.315 0.336
	Rod actuator finely adjustable from 10° to 10°	D						
	• Molded plastic rod (3SX3211 + 3SX3215)		40 56	3SE□ 1□0-1WW 3SE2 100-1WW	82.00 82.00	3SE□ 1□0-8WW00 3SE2 100-8WW00	82.00 82.00	0.315 0.346
	• Aluminum rod (3SX3211 + 3SX3214)		40 56	3SE□ 1□0-1VW 3SE2 100-1VW	83.00 83.00	3SE□ 1□0-8VW00 3SE2 100-8VW00	83.00 83.00	0.320 0.355
	Wobble spring (3SX3126)	–	40 56	3SE□ 1□0-1R 3SE2 100-1R	81.00 81.00	3SE□ 1□0-8RV00 3SE2 100-8RV00	81.00 81.00	0.230 0.270
	Fork lever, latching (3SX3127 + 3SX3115)	–	40 56	3SE□ 1□0-1T 3SE2 100-1T	117.00 117.00	– –	– –	0.340 0.360
	Switch body							
	with switch block		40	3SE□ 1□0-1A	44.00	3SE□ 1□0-8AV00	44.00	0.175
	without actuator		56	3SE2 100-1A	44.00	3SE3 100-8AV00	44.00	0.203

Order No. suffix

- with metric connecting thread M 20 x 1.5
I.E. 3SE□1□0
- with 1/2" - NPT connecting thread
I.E. 3SE□1□0

2.2

3.7

2.2

3.7

For operation, operating speed and travel, see Pages 13/100 to 13/105.

- Positive opening acc. to IEC 60 947-5-1, Appendix K, and DIN VDE 0660 Part 200.

- The actuator heads can be subsequently exchanged (see Page 13/95).
- For conduit thread adaptors see page 13/97.

3SE International Limit Switches

Position Switches

3SE2120 Specials
Metal enclosure, 40mm width

Selection and ordering data

2 contacts · Moving double break contacts · IP 67 degree of protection · EN 50 041 · with 4-pole or 5-pole male receptacle

40 mm wide



Actuator design to EN 50 041

Enclosure width







3SE3 position switches
with 2 snap-action contacts

Weight approx.



Identification number 11 acc. to EN 50 013, switch block 3SE3 000-1A)

www.DataSheet4U.com

	Actuator ¹⁾	mm	Order No.	List Price \$ 1 unit	kg	
 NSC00096	Plunger • with 4-pole, M12 male receptacle • with 5-pole, M12 male receptacle	–	40	→ 3SE2 120-1BV00-0AC4 → 3SE2 120-1BV00-0AC5	67.00 70.00	0.200 0.200
 NSC00097	Overtravel plunger • with 4-pole, M12 male receptacle • with 5-pole, M12 male receptacle	B	40	→ 3SE2 120-1CV00-0AC4 → 3SE2 120-1CV00-0AC5	84.00 87.00	0.200 0.200
 NSC 00098	Roller plunger • with 4-pole, M12 male receptacle • with 5-pole, M12 male receptacle	C	40	→ 3SE2 120-1DV00-0AC4 → 3SE2 120-1DV00-0AC5	91.00 94.00	0.265 0.265
 NSC 00099	Roller lever • with 4-pole, M12 male receptacle • with 5-pole, M12 male receptacle	–	40	→ 3SE2 120-1EV00-0AC4 → 3SE2 120-1EV00-0AC5	80.00 83.00	0.225 0.200
 NSC00093	Angular roller lever • with 4-pole, M12 male receptacle • with 5-pole, M12 male receptacle	–	40	→ 3SE2 120-1FV00-0AC4 → 3SE2 120-1FV00-0AC5	67.00 70.00	0.230 0.230
 NSC 00094	Roller crank • finely adjustable from 10° to 10° • with 4-pole, M12 male receptacle • with 5-pole, M12 male receptacle	A	40	→ 3SE2 120-1GW00-0AC4 → 3SE2 120-1GW00-0AC5	88.00 91.00	0.310 0.310
 NSC 00099	• adjustable length, finely adjustable from 10° to 10° • with 4-pole, M12 male receptacle • with 5-pole, M12 male receptacle			3SE2 120-1UW00-0AC4	104.00	0.325
	Switch body with contact block without operating head • with 4-pole, M12 male receptacle • with 5-pole, M12 male receptacle	–	40	3SE2 120-1AV00-0AC4 3SE2 120-1AV00-0AC5	61.00 64.00	0.180 0.180

Wiring Diagram for M12 Connections

M12 Pin	Limit Switch, Snap-Action Contacts ²⁾		Typical M12 Cable ³⁾	
	4-pole Connection	5-pole Connection	4-wire Connection	5-wire Connection
1	21	21	Brown	Brown
2	22	22	White	White
3	13	13	Blue	Blue
4	14	14	Black	Black
5	N/A	Ground	N/A	Green



4-pole 5-pole
Male Receptacle

→ Positive opening acc. to IEC 60 947-5-1, Appendix K

1) The actuator heads can be subsequently exchanged (see Page 13/95).
2) 21 & 22 = Normally Closed; 13 & 14 = Normally Open.













3) Typical M12 female plug with 5 meter cable.
4-pole 5-pole
Right-angle 3RX1542 3RX1631
Straight 3RX1513 3RX1570

3SE International Limit Switches Position Switches

3SE2 120 Specials
Metal enclosure, 40 and 56 mm width

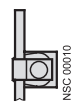
Selection and ordering data

2 contacts · Moving double break contacts · IP 67 degree of protection · EN 50 041
1 or 2 LEDs · Stainless steel roller/rod · Increased corrosion protection

40 mm wide ²⁾	Actuator design to EN 50 041	Enclosure width	3SE3 position switches with 2 snap-action contacts	Weight approx.
			 6 mm stroke Identification number 11 acc. to EN 50 013 switch block 3SE3 000-8AV00 ²⁾	
Actuator ¹⁾	mm	Order No.	List Price \$ 1 unit	kg
	–	40	→ 3SE2120-1AV00-0AF0 + 3SX3100 ⁵⁾ → 3SE2 120-1BV00-0AK0 52.00	0.220 0.200
	B	40	→ 3SE2120-1AV00-0AF0 + 3SX3106 ⁵⁾ → 3SE2 120-1CV00-0AK0 69.00	0.260 0.240
	C	40	→ 3SE2120-1DV00-0AF0 99.00 → 3SE2120-1DV00-0AF1 108.00 → 3SE2120-1DV00-0AA3 92.00 → 3SE2120-1DV00-0AK0 76.00	0.250 0.250 0.255 0.250
	–	40	→ 3SE2120-1EV00-0AF0 88.00 → 3SE2120-1EV00-0AA3 85.00 → 3SE2120-1EV00-0AK0 65.00	0.215 0.200 0.210
	–	40	→ - → 3SE2120-1FV00-0AA3 82.00 → 3SE2120-1FV00-0AK0 62.00	0.240 0.210
	A	40	→ 3SE2120-1GW00-0AF0 96.00 → 3SE2120-1GW00-0AA3 93.00 → 3SE2120-1GW00-0AK0 73.00	0.305 0.315 0.310
			3SE2120-1UW00-0AF0 112.00 3SE2120-1UW00-0AA3 109.00 3SE2120-1UW00-0AK0 89.00	0.310 0.315 0.315
	D	40	- 3SE2120-1WW00-0AK0 84.00	0.315
			- 3SE2120-1VW00-0AK0 85.00	0.320
	–	40	- 3SE2120-1RV00-0AL0 78.00 3SE2120-1RV00-0AK0 83.00	0.200 0.200
	–	40	- 3SE2120-1TV00-0AA3 220.00 3SE2120-1TV00-0AK0 119.00	0.355 0.345
	–	40	3SE2120-1AV00-0AF0 69.00 3SE2120-1AV00-0AF1 78.00	0.185 0.200

→ Positive opening acc. to IEC 60 947-5-1, Appendix K

1) The actuator heads can be subsequently exchanged (see Page 13/95).

2) For conduit thread adaptors see page 13/97.

3) The switch contacts have changed from their normal state.

4) Green LED – There is power to the switch. Yellow LED – The switch contacts have changed from their normal state.

5) Two parts required. Order separately.

3SE International Limit Switches

Position Switches

3SE2 100 to 3SE3 170, 3SE2 230

Selection and ordering data

Switch Bodies with replaceable contact block without operating head

Metal Housing
40 mm¹⁾



3SE2 120
3SE3 170

56 mm¹⁾



3SE2 100

Molded Plastic Housing
40 mm²⁾



3SE2 230

3SE2100, 3SE2120, 3SE2230 and 3SE3170 limit switches with field replaceable contact blocks may be provided as complete devices; or, separately as components; switch body, operating head and lever (if applicable).

Switch Bodies are complete except for the operating head and lever (if applicable). The contact blocks are field replaceable and have a molded plastic housing in which the fixed contacts and the terminals are located.

Operating Heads include the necessary hardware to mount to the selected Switch Body and may require an **Operating Lever**.

Plunger, Overtravel Plunger, Roller Plunger, Roller Lever, Angular Roller Lever and Wobble Spring operating heads are complete so only a Switch Body is required.

Side rotary operating heads such as Roller Crank, Adjustable Roller Crank, Fork Lever and Rod Actuator require a side rotary Operating Head and a suitable Lever. Therefore three parts are required for a complete switch; Switch Body, Operating Head, suitable Lever.

Operating heads for the 3SE2100, 3SE2120 and 3SE3170 series are interchangeable with each other and the various contact configurations. The same operating heads are also used in the 3SE2303 and 3SE2404 series. These switches are not available in parts.

Operating heads for the 3SE2230 series are interchangeable with the various contact configurations and may also require a lever (side rotary operating head).

Switch Body with Contact Block without Operating Head

Housing Style		Contact Arrangement																	
		1 NO + 1 NC Slow-action			1 NO + 1 NC Snap-action			1 NO + 1 NC, Slow-action Make-Before-Break			2 NC Slow-action			2 NO Slow-action			2 NC Snap-action		
		Order No.	List Price \$ 1 Unit	Weight Approx. kg	Order No.	List Price \$ 1 Unit	Weight Approx. kg	Order No.	List Price \$ 1 Unit	Weight Approx. kg	Order No.	List Price \$ 1 Unit	Weight Approx. kg	Order No.	List Price \$ 1 Unit	Weight Approx. kg	Order No.	List Price \$ 1 Unit	Weight Approx. kg
56 mm Wide Metal Housing with M20 x 1.5 Threaded Opening																			
	3SE2100-0A	44.00	0.202	3SE2100-1A	44.00	0.203	3SE2100-3A	44.00	0.205	3SE2100-6A	44.00	0.200	3SE2100-7A	44.00	0.203	3SE2100-8AV00	44.00	0.175	
40 mm Wide Metal Housing with M20 x 1.5 Threaded Opening																			
	3SE2120-0A	44.00	0.175	3SE2120-1A	44.00	0.175	3SE2120-3A	44.00	0.175	3SE2120-6A	44.00	0.175	3SE2120-7A	44.00	0.190	3SE2120-8AV00	44.00	0.175	
40 mm Wide Metal Housing with M20 x 1.5 Threaded Opening and One 24V LED																			
	—	—	—	3SE2120-1AV00-0AF0	69.00	0.185	—	—	—	—	—	—	—	—	—	—	—	—	—
40 mm Wide Metal Housing with M20 x 1.5 Threaded Opening and Two 24V LEDs																			
	—	—	—	3SE2120-1AV00-0AF1	78.00	0.200	—	—	—	—	—	—	—	—	—	—	—	—	—
40 mm Wide Metal Housing with M12 male Receptacle, 4-Poles																			
	—	—	—	3SE2120-1AV00-0AC4	61.00	0.180	—	—	—	—	—	—	—	—	—	—	—	—	—
40 mm Wide Metal Housing with M12 male Receptacle, 5-Poles																			
	—	—	—	3SE2120-1AV00-0AC5	64.00	0.180	—	—	—	—	—	—	—	—	—	—	—	—	—
40 mm Wide Metal Housing with 1/2" NPT Threaded Opening																			
	3SE3170-0A	44.00	0.171	3SE3170-1A	44.00	0.169	3SE3170-3A	44.00	0.182	3SE3170-6A	44.00	0.174	3SE3170-7A	44.00	0.170	3SE3170-8AV00	44.00	0.170	
40 mm Wide Plastic Housing with M20 x 1.5 Threaded Opening																			
	3SE2230-0A	31.00	0.095	3SE2230-1A	31.00	0.100	3SE2230-3A	31.00	0.095	3SE2230-6A	31.00	0.095	3SE2230-7A	31.00	0.095	3SE2230-8AV00	31.00	0.130	

¹⁾ Shown with operating head. See catalog page 13/95 and 13/96 for operating heads and levers.







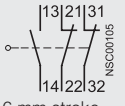
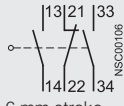
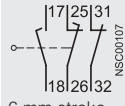
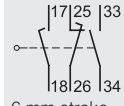

²⁾ Shown with operating head. See catalog page 13/83 for operating heads and levers.

3SE International Limit Switches Position Switches

3SE2 303
Metal enclosure, 56 mm width

Selection and ordering data

3 contacts · Wide enclosure · Moving double break contacts · IP 67 degree of protection · M20 x 1.5 connecting thread

56 mm wide ²⁾		3SE. position switches with mit 3 slow-action contacts	3SE. position switches with mit 3 slow-action contacts	3SE. position switches with 3 slow-action make- before-break contacts	3SE. position switches with 3 slow-action make-before-break contacts	Wght approx.	
		 6 mm stroke Identification number 12 acc. to EN 50 013, switch block 3SE3 003-0A	 6 mm stroke Identification number 21 acc. to EN 50 013, switch block 3SE3 003-1A	 6 mm stroke Identification number 12 acc. to EN 50 013, switch block 3SE3 003-2A	 6 mm stroke Identification No. 21 acc. to EN 50 013, switch block 3SE3 003-3A		
		Order No.	Order No.	Order No.	Order No.	List Price \$ 1 unit	kg
Actuator ¹⁾							
 NSC00096	Plunger (3SX3100)	→ 3SE2 303-0B	→ 3SE2 303-1B	→ 3SE2 303-2B	→ 3SE2 303-3B	99.00	0.310
 NSC00097	Overtravel plunger (3SX3106)	→ 3SE2 303-0C	→ 3SE2 303-1C	→ 3SE2 303-2C	→ 3SE2 303-3C	94.00	0.332
 NSC 00098	Roller plunger (3SX3107)	→ 3SE2 303-0D	→ 3SE2 303-1D	→ 3SE2 303-2D	→ 3SE2 303-3D	102.00	0.356
 NSC 00099	Roller lever Actuator made of molded plastic (3SX3102)	→ 3SE2 303-0E	→ 3SE2 303-1E	→ 3SE2 303-2E	→ 3SE2 303-3E	91.00	0.314
 NSC00093	Angular roller lever Actuator made of molded plastic (3SX3104)	→ 3SE2 303-0F	→ 3SE2 303-1F	→ 3SE2 303-2F	→ 3SE2 303-3F	87.00	0.330
 NSC 00094	Roller crank • finely adjustable from 10° to 10° (3SX3211 + 3SX3212)	→ 3SE2 303-0GW	→ 3SE2 303-1GW	→ 3SE2 303-2GW	→ 3SE2 303-3GW	98.00	0.411
 NSC 00098	• adjustable length, finely adjustable from 10° to 10° (3SX3211 + 3SX3213)	3SE2 303-0UW	3SE2 303-1UW	3SE2 303-2UW	3SE2 303-3UW	114.00	0.415
 NSC 00010	Rod actuator finely adjustable from 10° to 10° • Molded plastic rod (3SX3211 + 3SX3215) • Aluminum rod (3SX3211 + 3SX3214)	3SE2 303-0WW 3SE2 303-0VW	3SE2 303-1WW 3SE2 303-1VW	3SE2 303-2WW 3SE2 303-2VW	3SE2 303-3WW 3SE2 303-3VW	111.00 111.00	0.416 0.425

For operation, operating speed and travel, see Pages 13/106 to 13/112.

→ Positive opening acc. to IEC 60 947-5-1, Appendix K, and DIN VDE 0660 Part 200.

1) The actuator heads can be subsequently exchanged (see page 13/95).
2) For conduit thread adaptors see page 13/97.

1
2
3
4
5
6
7
8
9
10
11
12
13









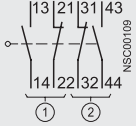
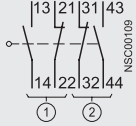
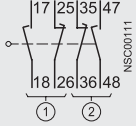

3SE International Limit Switches

Position Switches

3SE2 404
Metal enclosure, 56 mm width

Selection and ordering data

4 contacts · Wide enclosure · Moving double-break contacts · Degree of protection IP 67 · M20 x 1.5 connecting thread

56 mm wide ²⁾	3SE. position switches with 4 snap-action contacts		3SE. position switches with 4 slow-action contacts		3SE. position switches with 4 slow-action make before-break contacts		Wght approx.
	Order No.	List Price \$ 1 unit	Order No.	List Price \$ 1 unit	Order No.	List Price \$ 1 unit	
	 6 mm stroke Identification number 22 acc. to EN 50 013 ① Switch block 3SE3 000-1A ② Switch block 3SE3 010-1A		 6 mm stroke Identification number 22 acc. to EN 50 013 ① Switch block 3SE3 000-0A ② Switch block 3SE3 010-0A		 6 mm stroke Identification number 22 acc. to EN 50 013 ① Switch block 3SE3 000-3A ② Switch block 3SE3 010-3A		
Actuator ¹⁾							kg
 NSC00096	→ 3SE2 404-1B	121.00	→ 3SE2 404-0B	121.00	→ 3SE2 404-2B	121.00	0.380
 NSC00097	→ 3SE2 404-1C	138.00	→ 3SE2 404-0C	138.00	→ 3SE2 404-2C	138.00	0.400
 NSC 00098	→ 3SE2 404-1D	189.00	→ 3SE2 404-0D	147.00	→ 3SE2 404-2D	147.00	0.420
 NSC 00099	→ 3SE2 404-1E	136.00	→ 3SE2 404-0E	136.00	→ 3SE2 404-2E	136.00	0.381
 NSC00093	→ 3SE2 404-1F	132.00	→ 3SE2 404-0F	132.00	→ 3SE2 404-2F	132.00	0.400
 NSC 00094	→ 3SE2 404-1GW	181.00	→ 3SE2 404-0GW	141.00	→ 3SE2 404-2GW	141.00	0.480
 NSC 00099	3SE2 404-1UW	161.00	3SE2 404-0UW	161.00	3SE2 404-2UW	161.00	0.479
 NSC 00070	3SE2 404-1WW	155.00	3SE2 404-0WW	155.00	3SE2 404-2WW	155.00	0.490
	3SE2 404-1VW	155.00	3SE2 404-0VW	155.00	3SE2 404-2VW	155.00	0.490
 NSC 00101	3SE2 404-1T	193.00	–	–	–	–	0.515

For operation, operating speed and travel, see Pages 13/100 to 13/105.

→ Positive opening acc. to IEC 60 947-5-1, Appendix K, and DIN VDE 0660 Part 200.

1) The actuator heads can be subsequently exchanged (see page 13/95).
2) For conduit thread adaptors see page 13/97.

3SE International Limit Switches







Position Switches

3SE2 100 to 3SE3 170 / 3SE2 303 / 3SE2 404
Metal enclosure, 40 and 56 mm width

Accessories

Actuator heads lamps

The actuator heads of the position switches can be subsequently exchanged for other variants.

	Actuators with mounting screws	For position switches	Order No.	List Price \$	Weight approx.
		3SE2 100-□□ 3SE2 120-□□ 3SE2 230-□□ 3SE2 303-□□ 3SE2 404-□□ 3SE3 170-□□		1 unit	kg
	Plunger includes screws and gasket	-.B	3SX3 100	24.00	0.018
	Overtravel plunger includes screws and gasket	-.C	3SX3 106	43.00	0.056
	Roller plunger includes screws and gasket • standard roller • stainless steel roller	-.D	3SX3 107 3SX3 263	51.00 69.00	0.082 0.080
	Roller lever includes screws and gasket • standard roller • stainless steel roller	-.E	3SX3 102 3SX3 275	28.00 33.00	0.034 0.050
	Angular roller lever includes screws and gasket • standard roller • stainless steel roller	-.F	3SX3 104 3SX3 276	35.00 30.00	0.043 0.050
3SX3 126 	Wobble spring ¹⁾ (includes screws and gasket) • standard, spring 50 mm, plastic rod 50 mm • length 73 mm, spring 23.5 mm, stainless steel rod 10 mm • length 113 mm, spring 23.5 mm, stainless steel rod 50 mm • length 139.5 mm, spring 50 mm, plastic rod 50 mm with increased corrosion protection • length 139.5 mm, spring 50 mm, stainless steel rod 50 mm • length 239.5 mm, spring 150 mm, plastic rod 50 mm • length 239.5 mm, spring 150 mm, stainless steel rod 50 mm	-.R	3SX3 126 3SX3 282 3SX3 285 3SX3 284 3SX3 281 3SX3 283 3SX3 311	59.00 66.00 66.00 85.00 77.00 66.00 82.00	0.049 0.020 0.020 0.050 0.060 0.070 0.080

¹⁾ Not for safety circuits





1
2
3
4
5
6
7
8
9
10
11
12
13

3SE International Limit Switches

Position Switches

3SE2 100 to 3SE3 170 / 3SE2 303 / 3SE2 404
Metal enclosure, 40 and 56 mm width

Accessories

Actuators with mounting screws		For position switches	Order No.	List Price \$	Weight approx.
		3SE2 100-□□ 3SE2 120-□□ 3SE2 303-□□ 3SE2 404-□□ 3SE3 170-□□		1 unit	kg
3SX3 211	 <p>Roller crank operating heads (without lever, includes screws & gasket)</p> <ul style="list-style-type: none"> • standard momentary (spring return), left and right operation • momentary (spring return), left and/or right operation • fork lever, maintained 	-GW, -U, -V, -W -GW, -U, -V, -W -1T	3SX3 211 3SX3 307 3SX3 127	41.00 48.00 65.00	0.112 0.085 0.131
3SX3 212	 <p>Roller crank levers (operating head not included)</p> <ul style="list-style-type: none"> • standard, plastic roller, 19 mm dia. • stainless steel roller, 19 mm dia. • plastic roller, 30 mm dia. • plastic roller, 50 mm dia. • rubber roller, 50 mm dia. 	-.GW	3SX3 212 3SX3 265 3SX3 278 3SX3 301 3SX3 280	9.00 21.75 17.00 16.00 18.00	0.020 0.025 0.020 0.020 0.020
3SX3 213	 <p>Adjustable length roller crank (operating head not included)</p> <ul style="list-style-type: none"> • levers with clamp <ul style="list-style-type: none"> • standard, plastic roller, 19 mm dia. • stainless steel roller, 19 mm dia. • plastic roller, 30 mm dia. • rubber roller, 50 mm dia. • levers without clamp <ul style="list-style-type: none"> • rubber roller, 50 mm dia. 	-.UW	3SX3 213 3SX3 268 3SX3 302 3SX3 304	24.00 37.00 30.00 32.00	0.024 0.030 0.025 0.020
3SX3 115	 <p>Fork lever (operating head not included)</p> <ul style="list-style-type: none"> • standard, plastic rollers, 19 mm dia. • stainless steel rollers, 19 mm dia. 	-1T	3SX3 115 3SX3 266	35.00 61.00	0.032 0.050
3SX3 215	 <p>Rod actuator (operating head not included)</p> <ul style="list-style-type: none"> • with support <ul style="list-style-type: none"> • standard, plastic rod • aluminum rod • without support <ul style="list-style-type: none"> • standard, plastic rod • aluminum rod 	-.WW -.VW -.WW -.VW	3SX3 215 3SX3 214 3SX3 000 3SX3 001	20.00 20.00 3.00 3.00	0.031 0.032 0.008 0.016

3SE International Limit Switches Position Switches

Accessories

Connectors

for fast installation and replacement of position and interlock switches

Design		Order No.	List Price \$	Weight approx.	
		Preferred type	1 unit	kg	
Cable connectors for 3SE2 (with M20 x 1.5)					
3SY3 131 	3SY3 123 	Receptacle (6-poles + ground) 250V max., 10A for M20 x 1.5 with 0.75 mm ² connecting leads, for 3SX3 123 cable plug, molded plastic, IP 65 degree of protection	3SY3 131	53.00	0.030
		Plug ¹⁾ Molded plastic enclosure, degree of protection IP 65, screw terminals	3SY3 123	57.40	0.064
3SY3 131 	3SY3 123 	Receptacle (4-pole), M 12 for M20 x 1.5 250V max., 4A for 3RX1 505 coupling plug, with 0.75 mm ² connecting lead, IP 67 degree of protection	3SY3 127	36.00	0.008
	3SY3 128 	Receptacle (5-pole), M 12 for M20 x 1.5 125V max., 4A for 3RX1584 with 0.25 mm ² connecting lead, IP 67 degree of protection	3SY3 128	36.00	0.006
	3RX1 505 	Plug (4-pole), M 12 with terminal compartment, can be pre- assembled	3RX1 505		0.016
3SX9918 	3RX1 584 	Plug (5-pole), M 12 with terminal compartment, can be pre- assembled	3RX1 584		0.016
5VF1182 		Plastic wire gland PG 13.5 (6 mm long, with seal) PG 11 (6 mm long, with seal)	5VF1 182 5VF1 181	5.00 5.00	
Adaptors for 3SE. (with M 16)					
	3SX1997	metal M16 x 1.5 to 1/2" NPT	3SX1997	8.40	0.022
Adaptors for 3SE2 (with M 20)					
	3SX9918	plastic M20 x 1.5 wire gland	3SB3901-0CK	5.00	0.011
	3SX1998	metal M20 x 1.5 to 1/2" NPT	3SX1998	8.60	0.022
	3SX9918	plastic M20 x 1.5 to 1/2" NPT	3SX9918	7.00	0.012
Adaptors for 3SE. (with M 25)					
	3SX1999	metal M 25 x 1.5 to 1/2" NPT	3SX1999	8.75	0.022





1) For wiring, a crimping tool is necessary, max. conductor size 1 mm².

3SE International Limit Switches

Position Switches

3SE2 100 to 3SE3 170 / 3SE2 303 / 3SE2 404
Metal enclosure, 40 and 56 mm width

Accessories and spare parts

Design	Fig.	For position switches	Order No.	List Price \$ 1 unit	Weight approx. kg	Pack Units	
Spare parts for 3SE. 1.0, 3SE. 230 and 3SE. 404							
1	2	Switch blocks with 2 contacts with moving double-break contacts <ul style="list-style-type: none"> with snap-action contacts <ul style="list-style-type: none"> - 1 NO + 1 NC - 2 NC with slow-action contacts <ul style="list-style-type: none"> - 1 NO + 1 NC - 2 NC - 2 NO with slow-action make-before-break contacts <ul style="list-style-type: none"> - 1 NO + 1 NC 					
			1	3SE. 1.0-1., 3SE2 230-1., 3SE2 404-1.	3SE3 000-1A	27.00	0.032
			1	3SE. 1.0-8., 3SE2 230-8., 3SE2 404-8.	3SE3 000-8AV00	27.00	0.020
			2	3SE. 1.0-0., 3SE. 230-0., 3SE. 404-0.	3SE3 000-0A	27.00	0.031
				3SE. 1.0-6., 3SE. 230-6.	3SE3 000-6A	27.00	0.029
				3SE. 1.0-7., 3SE. 230-7.	3SE3 000-7A	27.00	0.029
3	4	Switch blocks with repeat plunger with 2 contacts - 1 NO + 1 NC for position switches with 4 contacts with moving double-break contacts <ul style="list-style-type: none"> with snap-action contacts with slow-action contacts with slow-action make-before-break contacts 					
			3	3SE. 404-1.	3SE3 010-1A	37.00	0.033
			4	3SE. 404-0.	3SE3 010-0A	37.00	0.032
			4	3SE. 404-2.	3SE3 010-3A	29.00	0.034
Spare parts for 3SE. 303							
5		Switch blocks with 3 contacts with moving double-break contacts <ul style="list-style-type: none"> with slow-action contacts <ul style="list-style-type: none"> - 1 NO + 2 NC - 2 NO + 1 NC with slow-action make-before-break contacts <ul style="list-style-type: none"> - 1 NO + 2 NC - 2 NO + 1 NC 					
			5	3SE. 303-0.	3SE3 003-0A	53.00	0.047
			5	3SE. 303-1.	3SE3 003-1A	53.00	0.047
			5	3SE. 303-2.	3SE3 003-2A	41.00	0.047
			5	3SE. 303-3.	3SE3 003-3A	41.00	0.063

3SE International Limit Switches









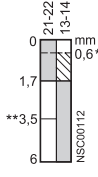
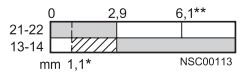

Position Switches

3SE3 020 / 3SE3 023
Open type

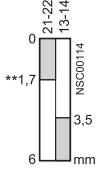
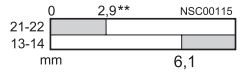
Selection and ordering data

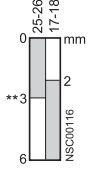
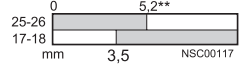
2 contacts · Moving double break contacts · Degree of protection: Terminals IP 20, switching chamber IP 40

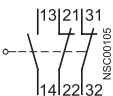
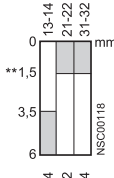
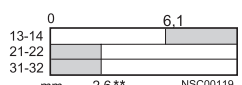
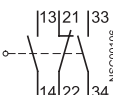
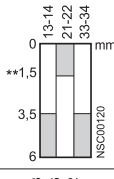
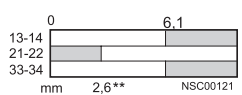
Tandem arrangement (2 × 2 contacts) is possible when 3SY3 121 adapter is used (see accessories below).

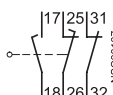
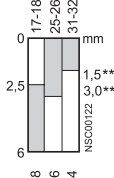
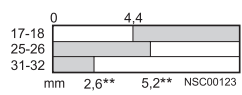
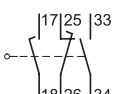
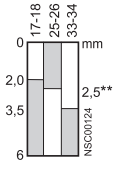
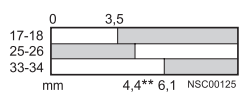
Internal circuit diagram Term. design. acc. to EN 50 013	Order No.	List Price \$	Weight approx.	Nominal travel and related terminals	Minimum force required along plunger axis
	Preferred type	1 unit	kg	0-line commencement of plunger travel ■ contact closed □ contact open * operating point on return ** positive opening acc. to IEC 60 947-5-1-3 along plunger axis perpend. to plunger axis $\alpha = 30^\circ$	
Snap-action contacts, 6 mm stroke					
3SE3 020-1A  	with 21 mm long plunger, 6mm Hub → 3SE3 020-1A 25.00	0.036	 	6 N	
3SE3 020-0A  	with 21 mm long plunger, 6mm Hub → 3SE3 020-0A 25.00	0.036	 	8 N	
Slow-action make-before-break contacts, 6 mm stroke					
3SE 020-3A  	with 21 mm long plunger → 3SE3 020-3A 25.00	0.036	 	8 N	
	Intermediate piece for tandem arrangement of 2-pole open-type position switches 3SY3 121 2.00	0.001			
3 contacts · Moving double break contacts · Degree of protection: Terminals IP 20, switching chamber IP 40					
Slow-action contacts, 6 mm stroke					
3SE3 023-0A  	with 21 mm plunger and repeat plunger, for tandem arrangement, 6mm Hub → 3SE3 023-0A 39.00	0.051	 	11 N	
	→ 3SE3 023-1A 39.00	0.051	 	13 N	
Slow-action make-before-break contacts, 6 mm stroke					
3SE3 023-2A  	with 21 mm plunger and repeat plunger, for tandem arrangement, 6mm Hub → 3SE3 023-2A 39.00	0.051	 	11 N	
	→ 3SE3 023-3A 39.00	0.058	 	13 N	

→ Safety function according to IEC 60 947-5-1, Appendix K.

For operation, operating speed and travel, see Page 13/112.

3SE International Limit Switches

Position Switches

3SE2 100 to 3SE3 170 / 3SE2 404
Metal enclosure, 40 and 56 mm width

Operation, operating speed and travel or angle of actuators

2 contacts · Standard and wide enclosure

Bars, cams, stops, etc. are used as actuating devices. The shape of the actuating device must provide the given angles for the leading and trailing edges.

For operation from the side, sparingly greased steel, POM (polyoxymethylene or polyacetal) or PA (polyamide) should be used as cam and bar material.

Operating speed along plunger axis

The actuating speed in the case of position switches with slow-action contacts is not permitted

to go lower than 15 mm/s for DC and 1 mm/s for AC. Position switches with snap-action contacts should be used when the speeds are lower.

3SE2 404 position switches · 4 contacts · Wide enclosure

The data for operation, operating speed, travel and angle of operation is the same as for the

position switches with 2 switch blocks.

Two switch blocks with 2 contacts are used for position switches with 4 contacts.

Operation by a bar	Switch blocks	Nominal travel and related terminals	Switch blocks	Nominal travel and related terminals
operating pt acc. to EN 50 041 v_{max} max. operating speed 0-line ref. line acc. to EN 50 041 H travel difference → direction of operation	Terminal designation acc. to EN 50 013	0-line reference line acc. to EN 50 041 S travel acc. to EN 50 041 ■ contact closed □ contact open * operating point on return ** positive opening acc. to IEC 60 947-5-1-3		

Plunger along plunger axis perpendicular to plunger axis along plunger axis

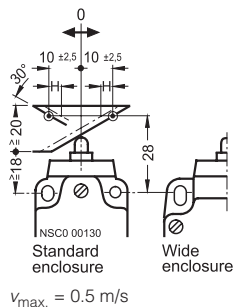
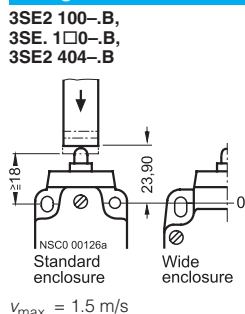

Minimum force required in direction of operation: 12 N

Slow-action contacts

1 NC + 1 NO

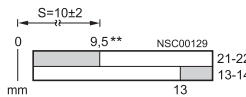
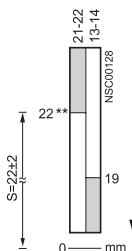
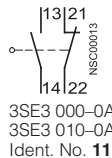

2 NC

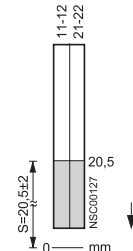
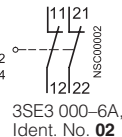

1 NO + 1 NC with make-before-break

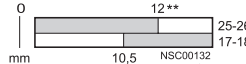
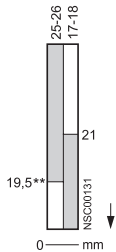
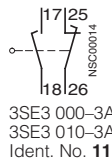

2 NO

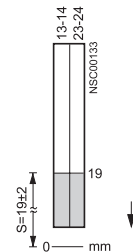
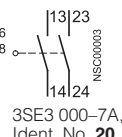

Snap-action contacts

1 NC + 1 NO

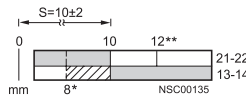
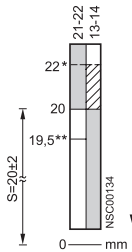
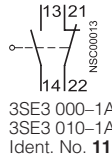

2 NC

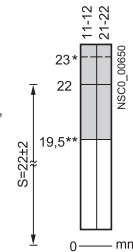
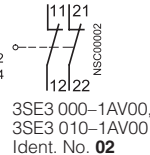

3SE International Limit Switches

Position Switches

3SE2 100 to 3SE3 170 / 3SE2 230 / 3SE2 404
Metal enclosure, 40 and 56 mm width

Operation, operating speed and travel or angle of actuators

2 or 4 contacts · Standard and wide enclosure

Operation by a bar	Switch blocks	Nominal travel and related terminals	Switch blocks	Nominal travel and related terminals
<ul style="list-style-type: none"> ⊙ operating pt. acc. to EN 50 041 V_{max} max. operating speed 0-line ref. line acc. to EN 50 041 H travel difference → direction of operation 	Terminal designation acc. to EN 50 013	<ul style="list-style-type: none"> 0-line reference line acc. to EN 50 041 S travel acc. to EN 50 041 contact closed contact open * operating point on return ** positive opening acc. to IEC 60 947-5-1-3 		

Overtravel plunger, Type B

3SE2 100-C,
3SE 1□0-C,
3SE2 230-C,
3SE2 404-C

www.DataSheet4U.com

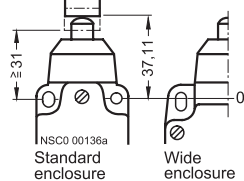

Wide enclosure

$V_{max.} = 1.5 \text{ m/s}$

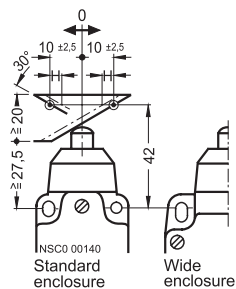

Wide enclosure

$V_{max.} = 0.5 \text{ m/s}$

Minimum force required in direction of operation: 32 N

Slow-action contacts

1 NC + 1 NO



3SE3 000-0A,
3SE3 010-0A,
Ident. No. **11**

along plunger axis

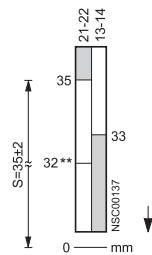

perpendicular to plunger axis

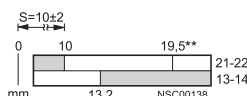

2 NC



3SE3 000-6A,
Ident. No. **02**

along plunger axis

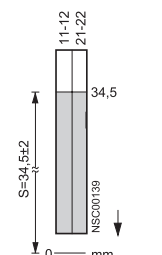

1 NO + 1 NC With make-before-break



3SE3 000-3A,
3SE3 010-3A,
Ident. No. **11**

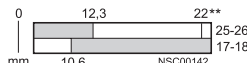
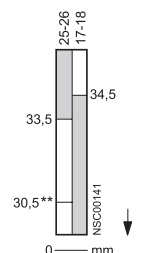

2 NO



3SE3 000-7A,
Ident. No. **20**

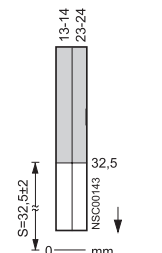

Snap-action contacts

1 NC + 1 NO



3SE3 000-1A,
3SE3 010-1A,
Ident. No. **11**

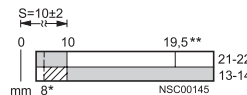
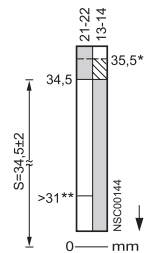

2 NC



Ident. No. **02**

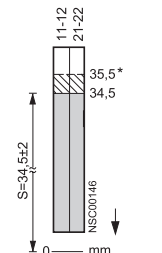

3SE International Limit Switches

Position Switches

3SE2 100 to 3SE3 170 / 3SE2 230 / 3SE2 404
Metal enclosure, 40 and 56 mm width

Operation, operating speed and travel or angle of actuators

2 or 4 contacts · Standard and wide enclosure

Operation by a bar	Switch blocks	Nominal travel and related terminals	Switch blocks	Nominal travel and related terminals
<ul style="list-style-type: none"> ⊙ operating pt acc. to EN 50 041 v_{max} max. operating speed 0-line ref. line acc. to EN 50 041 H travel difference → direction of operation 	Terminal designation acc. to EN 50 013	<ul style="list-style-type: none"> 0-line reference line acc. to EN 50 041 S travel acc. to EN 50 041 ■ contact closed □ contact open * operating point on return ** positive opening acc. to IEC 60 947-5-1-3 		

Roller plunger, type C

3SE2 100-D,
3SE. 1□0-D,
3SE2 230-D,
3SE2 404-D

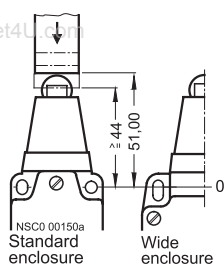

$v_{max.} = 1.5 \text{ m/s}$

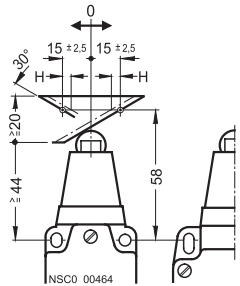

$v_{max.} = 1 \text{ m/s}$ (3SE3 230-1D),
 $v_{max.} = 0.5 \text{ m/s}$ (3SE3 1.0-1D),
 Minimum force required in direction of operation: 32 N

Slow-action contacts

1 NC + 1 NO

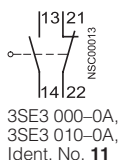

3SE3 000-0A,
 3SE3 010-0A,
 Ident. No. **11**

along plunger axis perpendicular to plunger axis

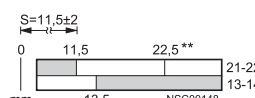
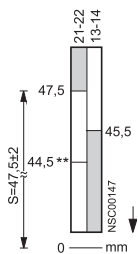

2 NC

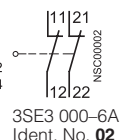

3SE3 000-6A,
 Ident. No. **02**

along plunger axis

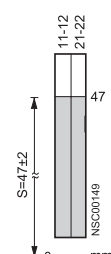

1 NO + 1 NC With make-before-break

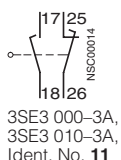

3SE3 000-3A,
 3SE3 010-3A,
 Ident. No. **11**

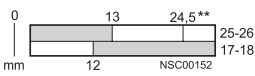
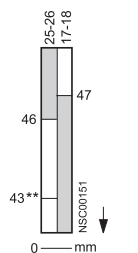

2 NO

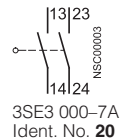

3SE3 000-7A,
 Ident. No. **20**

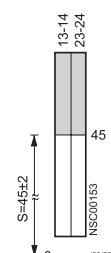

Snap-action contacts

1 NC + 1 NO

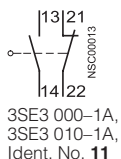

3SE3 000-1A,
 3SE3 010-1A,
 Ident. No. **11**

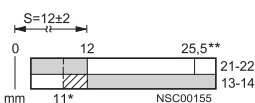
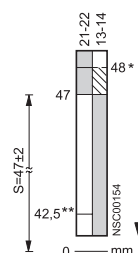

2 NC

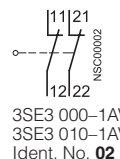

3SE3 000-1AV00,
 3SE3 010-1AV00,
 Ident. No. **02**

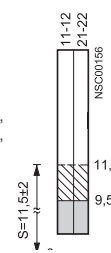

Fork lever

3SE2 100-1T,
3SE. 1□0-1T,
3SE2 404-1T

lateral actuation

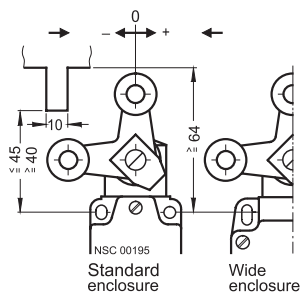

$v_{max.} = 2 \text{ m/s}$
 Minimum force required in direction of operation: 30 N

Deflection in direction of rotation

Snap-action contacts

1 NC + 1 NO

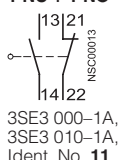

3SE3 000-1A,
 3SE3 010-1A,
 Ident. No. **11**

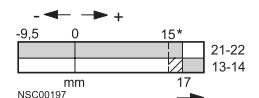
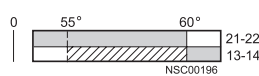

2 NC

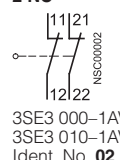

3SE3 000-1AV00,
 3SE3 010-1AV00,
 Ident. No. **02**



3SE International Limit Switches

Position Switches

3SE2 100 to 3SE3 170 / 3SE2 230 / 3SE2 404
Metal enclosure, 40 and 56 mm width

Operation, operating speed and travel or angle of actuators

2 or 4 contacts · Standard and wide enclosure

Operation by a bar	Switch blocks	Nominal travel and related terminals	Switch blocks	Nominal travel and related terminals
<ul style="list-style-type: none"> ⊙ operating pt. acc. to EN 50 041 α, γ approach angle v_{max} max. operating speed 0-line ref. line acc. to EN 50 041 H travel difference → direction of operation 	<ul style="list-style-type: none"> Terminal designation acc. to EN 50 013 	<ul style="list-style-type: none"> 0-line reference line acc. to EN 50 041 S travel acc. to EN 50 041  contact closed  contact open * operating point on return ** positive opening to IEC 60 947-5-1-3 		

Roller lever

3SE2 100-E, 3SE, 1□-E,
3SE2 230-E, 3SE2 404-E

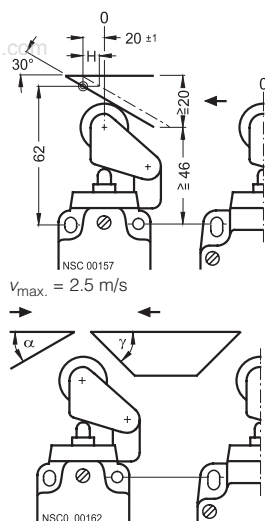

$v_{max} = 2.5 \text{ m/s}$
 $v_{max} = 1 \text{ m/s}$, $\alpha_{max} = 30^\circ$, $\gamma_{max} = 45^\circ$
Minimum force required in direction of operation: 12 N

Slow-action contacts

1 NC + 1 NO

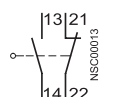
3SE3 000-0A,
3SE3 010-0A,
Ident. No. 11

1 NO + 1 NC
With make-bef-break

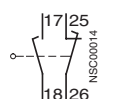

3SE3 000-3A,
3SE3 010-3A,
Ident. No. 11

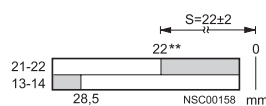
perpendicular to plunger axis

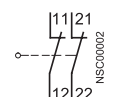

2 NC

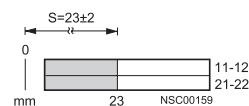
3SE3 000-6A,
Ident. No. 02



2 NO

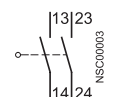

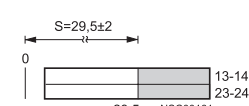
3SE3 000-7A,
Ident. No. 20

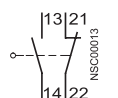

Snap-action contacts

1 NC + 1 NO

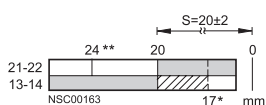
3SE3 000-1A,
3SE3 010-1A,
Ident. No. 11

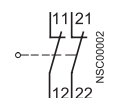

2 NC

Ident. No. 02

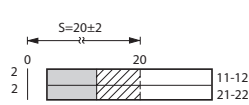

Angular roller lever

3SE2 100-F, 3SE, 1□-F,
3SE2 230-F, 3SE2 404-F

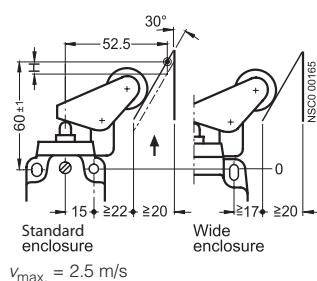

$v_{max} = 2.5 \text{ m/s}$

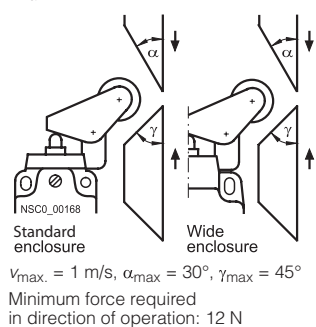

$v_{max} = 1 \text{ m/s}$, $\alpha_{max} = 30^\circ$, $\gamma_{max} = 45^\circ$
Minimum force required in direction of operation: 12 N

Slow-action contacts

1 NC + 1 NO

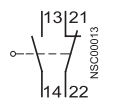
3SE3 000-0A,
3SE3 010-0A,
Ident. No. 11

1 NO + 1 NC
With make-before-break

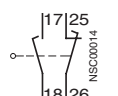
3SE3 000-3A,
3SE3 010-3A,
Ident. No. 11

along plunger axis

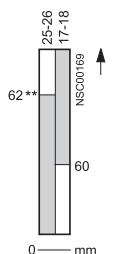
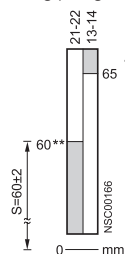

2 NC

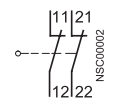

3SE3 000-6A,
Ident. No. 02

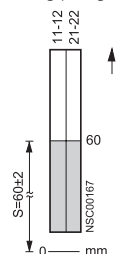
along plunger axis

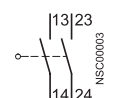

2 NO

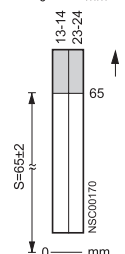

3SE3 000-7A,
Ident. No. 20

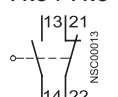

Snap-action contacts

1 NC + 1 NO

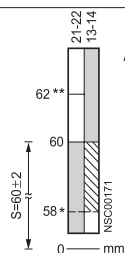
3SE3 000-1A,
3SE3 010-1A,
Ident. No. 11

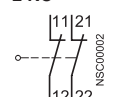

2 NC

Ident. No. 02

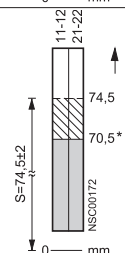

3SE International Limit Switches

Position Switches

3SE2 100 to 3SE3 170 / 3SE2 230 / 3SE2 404
Metal enclosure, 40 and 56 mm width

Operation, operating speed and travel or angle of actuators

2 or 4 contacts · Standard and wide enclosure

Operation by a bar	Switch blocks	Nominal travel and related terminals	Switch blocks	Nominal travel and related terminals
<ul style="list-style-type: none"> ⊙ operating pt acc. to EN 50 041 α approach angle β trailing angle v_{max} max. operating speed 0-line reference line acc. to EN 50 041 S travel acc. to EN 50 041 H travel difference → direction of operation 	Terminal designation acc. to EN 50 013	<ul style="list-style-type: none"> 0-line ref. line acc. to EN 50 041 S travel acc. to EN 50 041 ▬ contact closed □ contact open * operating point on return ** positive opening to IEC 60 947-5-1-3 		

Roller crank, type A

repositionable and finely adjustable from 10° to 10°

3SE2 100-GW, 3SE. 1□0-GW, 3SE2 230-GW, 3SE2 404-GW

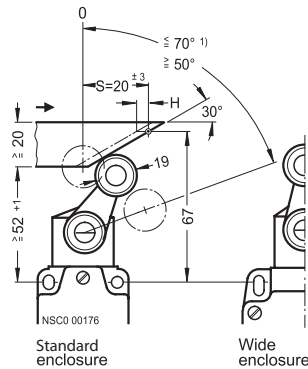

$v_{max} = 3 \text{ m/s}$

Minimum torque required in direction of operation: 25 Ncm

In special designs, contacts can only be operated from right or left. By twisting the plunger from the right and left.

Slow-action contacts

1 NC + 1 NO

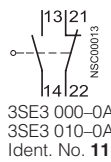

3SE3 000-0A, 3SE3 010-0A, Ident. No. 11

1 NO + 1 NC

With make-bef.-break

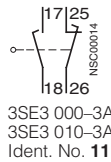

3SE3 000-3A, 3SE3 010-3A, Ident. No. 11

Snap-action contacts

1 NC + 1 NO

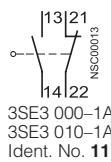

3SE3 000-1A, 3SE3 010-1A, Ident. No. 11

perpendicular to plunger axis

2 NC

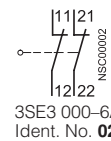

3SE3 000-6A, Ident. No. 02

2 NO

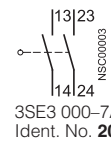

3SE3 000-7A, Ident. No. 20

perpendicular to plunger axis

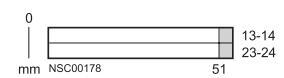
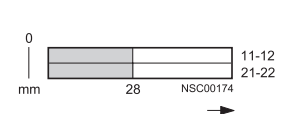

Roller crank, adjustable length

finely adjustable from 10° to 10°

3SE2 100-UW, 3SE. 1□0-UW, 3SE2 230-U, 3SE2 404-UW

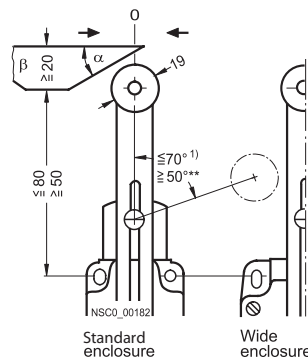

$v_{max} = 1 \text{ m/s}$, $\alpha_{max} = 30^\circ$, $\beta_{max} = 30^\circ$

Minimum torque required in direction of operation: 25 Ncm

Contact operation either from right or left or from right and left.

Slow-action contacts

1 NC + 1 NO

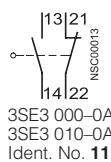

3SE3 000-0A, 3SE3 010-0A, Ident. No. 11

1 NO + 1 NC

With make-bef.-break

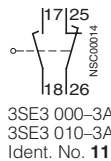

3SE3 000-3A, 3SE3 010-3A, Ident. No. 11

Snap-action contacts

1 NC + 1 NO

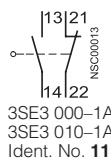

3SE3 000-1A, 3SE3 010-1A, Ident. No. 11

Deflection in direction of rotation

2 NC

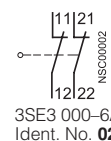

3SE3 000-6A, Ident. No. 02

2 NO

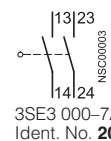

3SE3 000-7A, Ident. No. 20

Deflection in direction of rotation

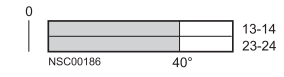
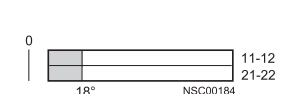

1) Max. operating angle 70°.

3SE International Limit Switches Position Switches

3SE2 100 to 3SE3 170 / 3SE2 230 / 3SE2 404
Metal enclosure, 40 and 56 mm width

Operation, operating speed and travel or angle of actuators

2 or 4 contacts · Standard and wide enclosure

Operation by a bar	Switch blocks	Nominal travel and related terminals	Switch blocks	Nominal travel and related terminals
<p>⊙ operating pt. acc. to EN 50 041</p> <p>V_{max} max. operating speed</p> <p>0-line ref. line acc. to EN 50 041</p> <p>→ direction of operation</p>	Terminal designation acc. to EN 50 013	<p>0-line ref. line acc. to EN 50 041</p> <p>■ contact closed</p> <p>□ contact open</p> <p>* operating point on return</p> <p>** positive opening to IEC 60 947-5-1-3</p>		

Rod actuator

finely adjustable from 10° to 10°

3SE2 100-WW, 3SE. 1□0-WW,
3SE2 230-W, 3SE2 404-WW

3SE2 100-VW, 3SE. 1□0-VW,
3SE2 230-V, 3SE2 404-VW

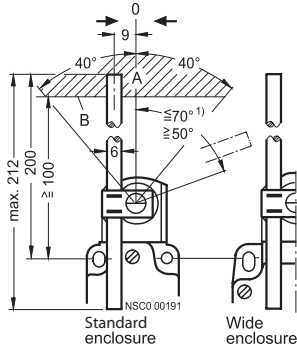

A = Operating range
B = Lower edge of actuator

V_{max} = 3 m/s

Minimum torque required
in direction of operation: 25 Nm

In special designs, contacts can only be operated from right or left. By twisting the plunger from the right and left.

Slow-action contacts

1 NC + 1 NO

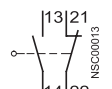

3SE3 000-0A,
3SE3 010-0A,
Ident. No. 11

1 NO + 1 NC With make-before-break

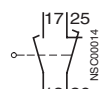

3SE3 000-3A,
3SE3 010-3A,
Ident. No. 11

Snap-action contacts

1 NC + 1 NO

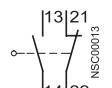

3SE3 000-1A,
3SE3 010-1A,
Ident. No. 11

Snap-action contacts

1 NC + 1 NO

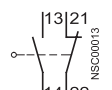

3SE3 000-1A,
3SE3 010-1A,
Ident. No. 11

in direction of rotation

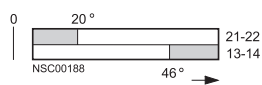

2 NC

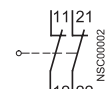

3SE3 000-6A,
Ident. No. 02

2 NO

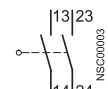

3SE3 000-7A,
Ident. No. 20

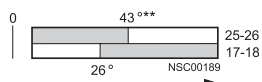

in direction of rotation

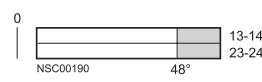
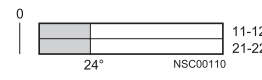

Deflection of spring rod

Spring rod

3SE2 100-1R, 3SE. 1□0-1R,
3SE2 230-R

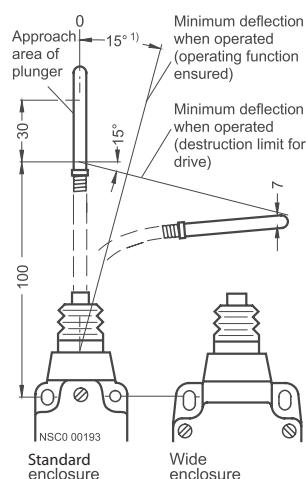

V_{max} = 1 m/s, approachable from all sides

Minimum force required
in direction of operation: 12 N
with lateral deflection at the tip: 2.5 N

1) Max. operating angle 70°.

3SE International Limit Switches

Position Switches

3SE2 303
Metal enclosure, 56 mm width

Operation, operating speed and travel or angle of actuators

3 contacts · Wide enclosure

Operation by a bar	Switch blocks	Nominal travel and related terminals	Minimum force required in direction of operation
<ul style="list-style-type: none"> ⊙ operating pt acc. to EN 50 041 v_{max} max. operating speed O-line reference line acc. to EN 50 041 H travel difference → direction of operation 	Terminal designation acc. to EN 50 013	<ul style="list-style-type: none"> O-line reference line acc. to EN 50 041 S travel acc. to EN 50 041 ■ contact closed □ contact open * operating point on return ** positive opening to IEC 60 947-5-1-3 	Minimum force required in direction of operation

Plunger

3SE2 303-B

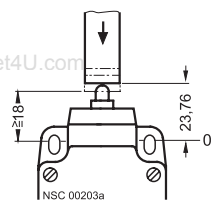

$v_{max.} = 1.5 \text{ m/s}$

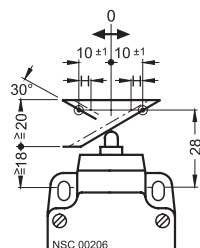

$v_{max.} = 0.5 \text{ m/s}$

Slow-action contacts

1 NO + 2 NC

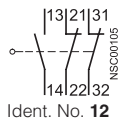

along plunger axis

perpendicular to plunger axis

16 N

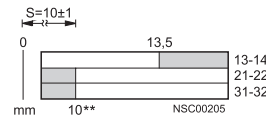
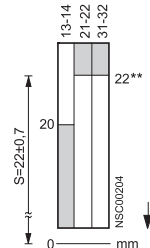

2 NO + 1 NC

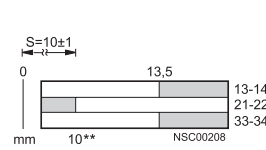
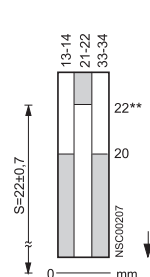
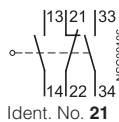

18 N

1 NO + 2 NC
make-before-break

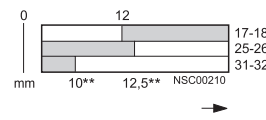
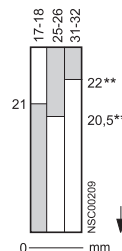
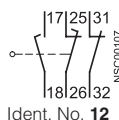

16 N

2 NO + 1 NC
make-before-break

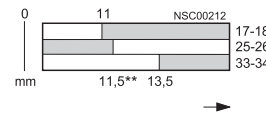
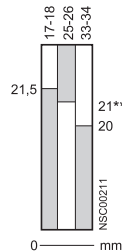
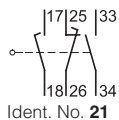

18 N

3SE International Limit Switches

Position Switches

3SE2 303
Metal enclosure, 56 mm width

1
2
3
4
5
6
7
8
9
10
11
12
13

Operation, operating speed and travel or angle of actuators

3 contacts · Wide enclosure

Operation by a bar	Switch blocks	Nominal travel and related terminals	Minimum force required in direction of operation
<ul style="list-style-type: none"> ⊙ operating pt. acc. to EN 50 041 V_{max} max. operating speed 0-line reference line acc. to EN 50 041 H travel difference → direction of operation 	Terminal designation acc. to EN 50 013	<ul style="list-style-type: none"> 0-line reference line acc. to EN 50 041 S travel acc. to EN 50 041 ■ contact closed □ contact open * operating point on return ** positive opening to IEC 60 947-5-1-3 	Minimum force required in direction of operation

Overtravel plunger

3SE2 303-C

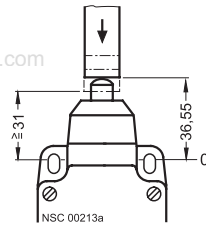

$V_{max.} = 1.5 \text{ m/s}$

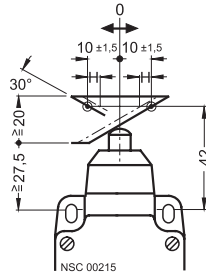

$V_{max.} = 0.5 \text{ m/s}$

Slow-action contacts

1 NO + 2 NC

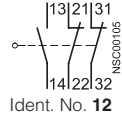

along plunger axis

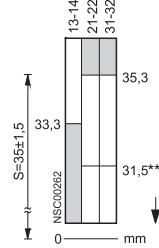

perpendicular to plunger axis

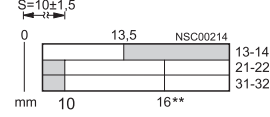

35 N

2 NO + 1 NC

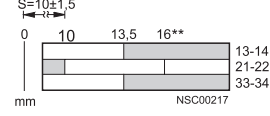
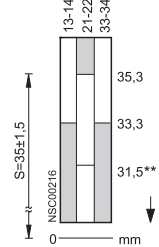
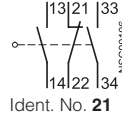

37 N

1 NO + 2 NC

make-before-break

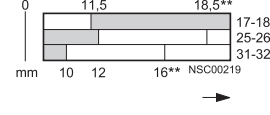
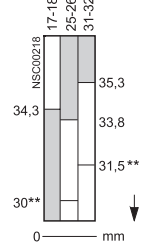
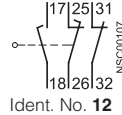

35 N

2 NO + 1 NC

make-before-break

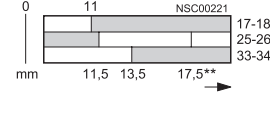
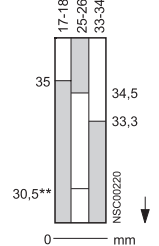
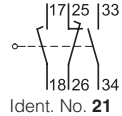

37 N

3SE International Limit Switches

Position Switches

3SE2 303
Metal enclosure, 56 mm width

Operation, operating speed and travel or angle of actuators

3 contacts · Wide enclosure

Operation by a bar	Switch blocks	Nominal travel and related terminals	Minimum force required in direction of operation
<ul style="list-style-type: none"> ⊙ operating pt. acc. to EN 50 041 v_{max} max. operating speed 0-line reference line acc. to EN 50 041 H travel difference → direction of operation 	Terminal designation acc. to EN 50 013	<ul style="list-style-type: none"> 0-line reference line acc. to EN 50 041 S travel acc. to EN 50 041 ■ contact closed □ contact open * operating point on return ** positive opening to IEC 60 947-5-1-3 	Minimum force required in direction of operation

Roller plunger

3SE2 303-D

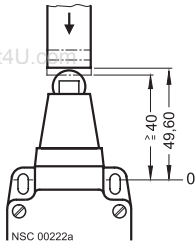

$v_{max.} = 1.5 \text{ m/s}$

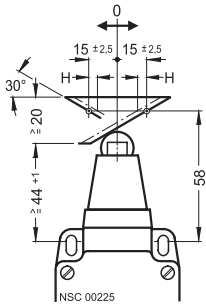

$v_{max.} = 1 \text{ m/s}$

Slow-action contacts

1 NO + 2 NC

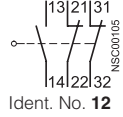

Ident. No. **12**

along plunger axis

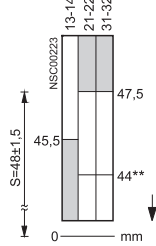

perpendicular to plunger axis

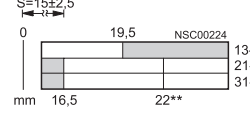

35 N

2 NO + 1 NC

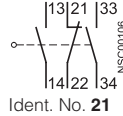

Ident. No. **21**

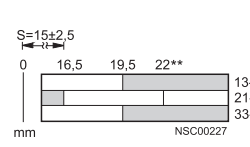
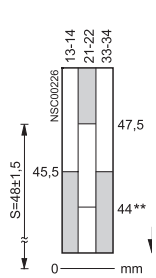

37 N

1 NO + 2 NC
make-before-break

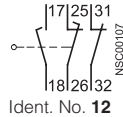

Ident. No. **12**

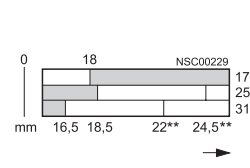
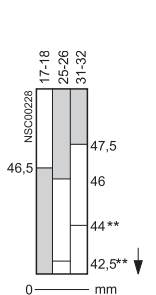

35 N

2 NO + 1 NC
make-before-break

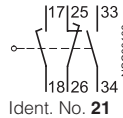

Ident. No. **21**

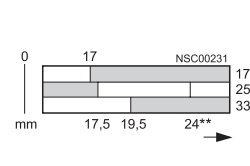
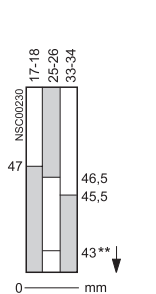

37 N

3SE International Limit Switches

Position Switches

3SE2 303
Metal enclosure, 56 mm width



Operation, operating speed and travel or angle of actuators

3 contacts · Wide enclosure

Operation by a bar	Switch blocks	Nominal travel and related terminals	Minimum force required in direction of operation
○ operating pt acc. to EN 50 041 α approach angle β trailing angle γ approach angle v_{max} max. operating speed 0-line reference line acc. to EN 50 041 H travel difference → direction of operation	Terminal designation acc. to EN 50 013	0-line reference line acc. to EN 50 041 S travel acc. to EN 50 041 ■ contact closed □ contact open ** positive opening to IEC 60 947-5-1-3	

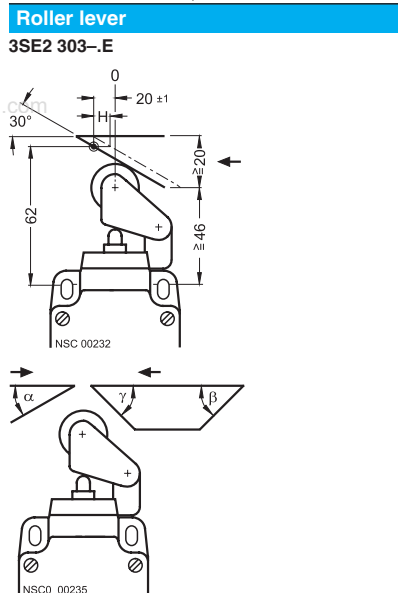

For operation perpendicular to plunger axis:
 $v_{max} = 1 \text{ m/s}$ at $\alpha_{max} = 30^\circ$
 $v_{max} = 2.5 \text{ m/s}$ at $\gamma_{max} = 45^\circ$
 $\beta_{max} = 45^\circ$
 For operation along plunger axis: $v_{max} = 1.5 \text{ m/s}$

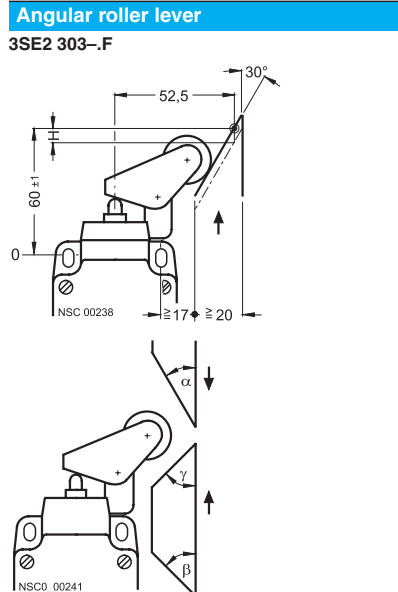

For operation along plunger axis:
 $v_{max} = 1 \text{ m/s}$ at $\alpha_{max} = 30^\circ$
 $v_{max} = 2.5 \text{ m/s}$ at $\gamma_{max} = 45^\circ$
 $v_{max} = 2.5 \text{ m/s}$ at $\beta_{max} = 45^\circ$

Switch blocks	Nominal travel and related terminals	Minimum force required in direction of operation
1 NO + 2 NC Ident. No. 12	perpendicular to plunger axis 	15 N
2 NO + 1 NC Ident. No. 21		17 N
1 NO + 2 NC make-before-break Ident. No. 12		15 N
2 NO + 1 NC make-before-break Ident. No. 21		17 N

Switch blocks	Nominal travel and related terminals	Minimum force required in direction of operation
1 NO + 2 NC Ident. No. 12	along plunger axis 	15 N
2 NO + 1 NC Ident. No. 21		17 N
1 NO + 2 NC make-before-break Ident. No. 12		15 N
2 NO + 1 NC make-before-break Ident. No. 21		17 N

3SE International Limit Switches

Position Switches

3SE2 303
Metal enclosure, 56 mm width

Operation, operating speed and travel or angle of actuators

3 contacts · Wide enclosure

Operation by a bar	Switch blocks	Nominal travel and related terminals	Minimum force required in direction of rotation
<ul style="list-style-type: none"> ⊙ operating pt acc. to EN 50 041 v_{max} max. operating speed 0-line reference line acc. to EN 50 041 H travel difference → direction of operation 	Terminal designation acc. to EN 50 013	<ul style="list-style-type: none"> 0-line reference line acc. to EN 50 041 S travel acc. to EN 50 041 ■ contact closed □ contact open ** positive opening to IEC 60 947-5-1-3 	Minimum force required in direction of rotation

Roller crank	Slow-action contacts	perpendicular to plunger axis	25 Ncm
finely adjustable from 10° to 10° 3SE2 303-.GW-Z A31	1 NO + 2 NC  Ident. No. 12	   	
 NSC 00244 $v_{max} = 3 \text{ m/s}$ In special designs contacts can only be operated from right or left. By twisting the plunger from the right and left.	2 NO + 1 NC  Ident. No. 21	 	
	1 NO + 2 NC make-before-break  Ident. No. 12	 	
	2 NO + 1 NC make-before-break  Ident. No. 21	 	

1) Max. operating angle 70°.
Max. deflection for adjustment purposes 90°.

3SE International Limit Switches

Position Switches

3SE2 303
Metal enclosure, 56 mm width

1
2
3
4
5
6
7
8
9
10
11
12
13

Operation, operating speed and travel or angle of actuators

3 contacts - Wide enclosure

Operation by a bar	Switch blocks	Nominal travel and related terminals	Minimum force required in direction of rotation
○ operating pt acc. to EN 50 041 α approach angle β trailing angle v_{max} max. operating speed 0-line reference line acc. to EN 50 041 → direction of operation	Terminal designation acc. to EN 50 013	0-line reference line acc. to EN 50 041 S travel acc. to EN 50 041 ■ contact closed □ contact open ** positive opening to IEC 60 947-5-1-3	

Roller crank, adjustable length

finely adjustable from 10° to 10°

3SE2 303-UW

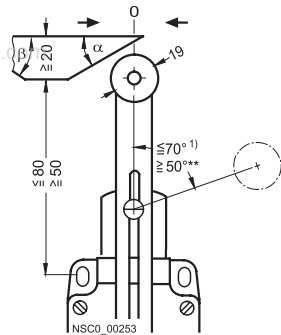

$v_{max} = 3 \text{ m/s}$,
 $\alpha_{max} = 30^\circ$,
 $\beta_{max} = 30^\circ$

In special designs contacts can only be operated from right or left. By twisting the plunger from the right and left.

Slow-action contacts

perpendicular to plunger axis

25 Ncm

1 NO + 2 NC

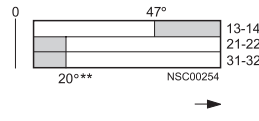
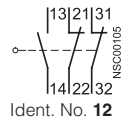

2 NO + 1 NC

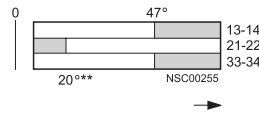
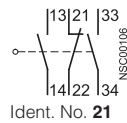

1 NO + 2 NC make-before-break

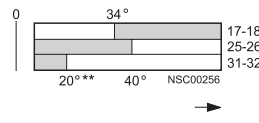
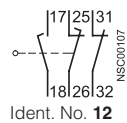

2 NO + 1 NC make-before-break

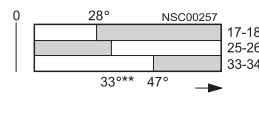
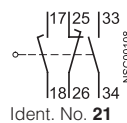

1) Max. operating angle 70°.

3SE International Limit Switches

Position Switches

3SE2 303 / 3SE3 02.
Metal enclosure, 56 mm width

Operation, operating speed and travel or angle of actuators

3 contacts · Wide enclosure

Operation by a bar	Switch blocks	Nominal travel and related terminals	Minimum force required in direction of rotation
☉ operating pt acc. to EN 50 041 v_{max} max. operating speed 0-line reference line acc. to EN 50 041 → direction of operation	Terminal designation acc. to EN 50 013	0-line reference line acc. to EN 50 041 S travel acc. to EN 50 041 ■ contact closed □ contact open ** positive opening to IEC 60 947-5-1-3	

Rod actuator	Slow-action contacts	Deflection in direction of rotation	Minimum force required in direction of rotation
finely adjustable from 10° to 10° 3SE2 303--WW, 3SE2 303--VW	1 NO + 2 NC  Ident. No. 12		25 Ncm

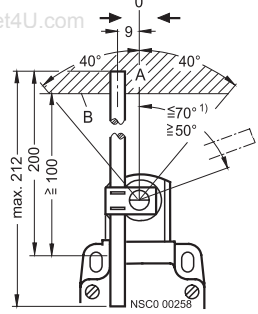

A = Operating range
 B = Lower edge of actuator

$v_{max} = 3$ m/s

In special designs contacts can only be operated from right or left. By twisting the plunger from the right and left.

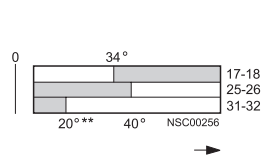
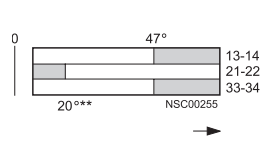
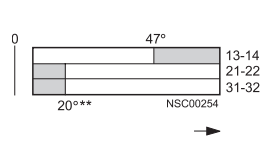
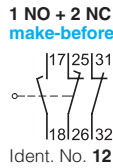
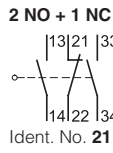
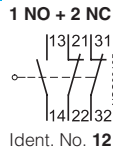

1) Max. operating angle 70°. Max. deflection for adjustment purposes 90°.

3SE3 020 and 3SE3 023 open-type position switches

2 and 3 contacts · Moving double break contacts · Degree of protection: Terminals IP 20, switching chamber IP 40

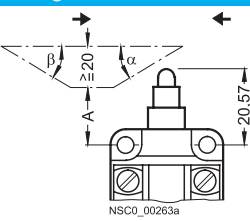
Operation by a bar	Type	A ≥ mm	A** ≤ mm	
Plunger				
	Actuators can be in the form of a bar, cam, stop etc.	3SE3 020-0A	15	–
	For operation perpendicular to plunger axis:	3SE3 020-1A	15	17.5
	$\alpha_{max} = 30^\circ$, $v_{max} = 0.5$ m/s	3SE3 020-3A	15	–
	$\beta_{max} = 30^\circ$			
	For operation perpendicular plunger axis:			
	$v_{max} = 1.5$ m/s			
A Actuating bar spacing = distance from center, fixing hole up to lower edge of contact bar	3SE3 023-0A	15	–	
	3SE3 023-1A	15	–	
	3SE3 023-2A	15	–	
A** Actuating bar distance, to guarantee positive opening of the snap-action contacts acc. to DIN VDE 0113.	3SE3 023-3A	15	–	

3SE International Limit Switches

Position Switches

3SE2 100 to 3SE3 170
Metal enclosure, 40 and 56 mm width

Dimension drawings

3SE2 1.0, 3SE3 1.0

3SE. 1□0
narrow enclosure, 2 contacts,
with plunger

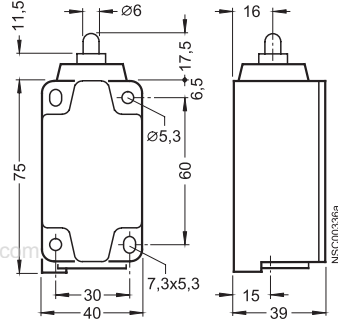

3SE2 100
wide enclosure, 2 contacts,
with plunger

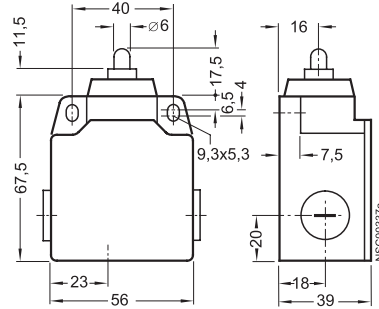

Actuators for 3SE2 1.0, 3SE3 1.0 position switches

Overtravel plunger, Form B

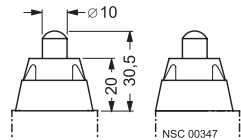

Roller plunger, Form C

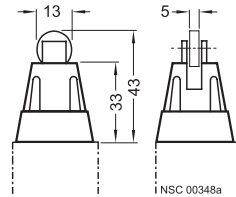

Roller lever

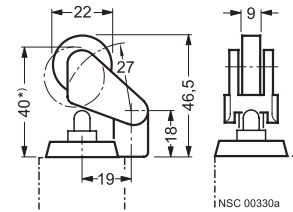

* Lever in final position

Angular roller lever

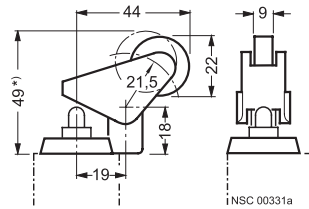

* Lever in final position

3SX3 212 roller crank for 3SX3 211 actuator heads

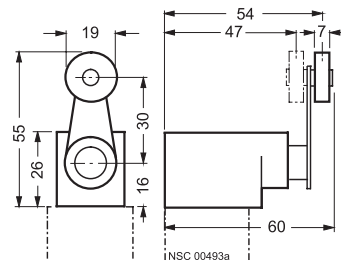

Fork lever

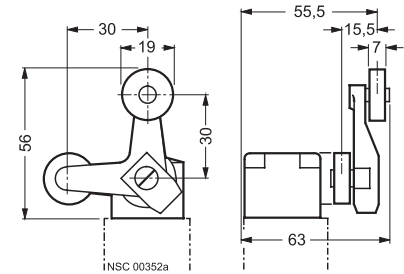

Roller crank, adjustable length

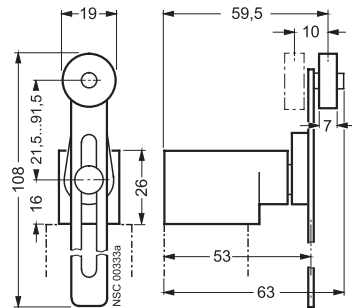

Rod actuator, adjustable length, Form D

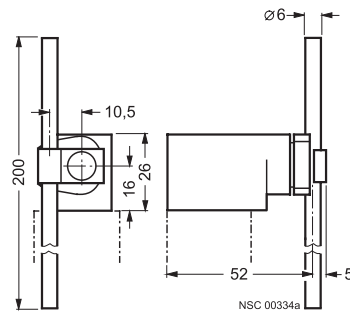

Wobble spring

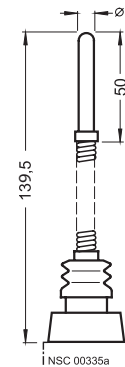

3SE International Limit Switches

Position Switches

3SE2 303 / 3SE2 404
Metal enclosure, 56 mm width

Dimension drawings

3SE2 303
 wide enclosure, 3 contacts

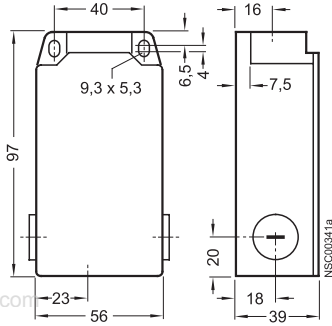

3SE2 404
 wide enclosure, 4 contacts

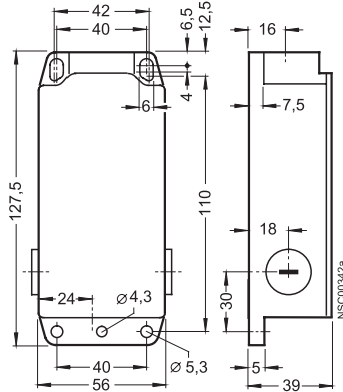

Open-type

3SE3 020-A

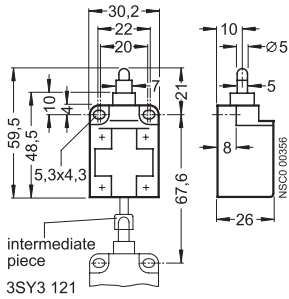

intermediate piece
 3SY3 121

3SE3 023-A

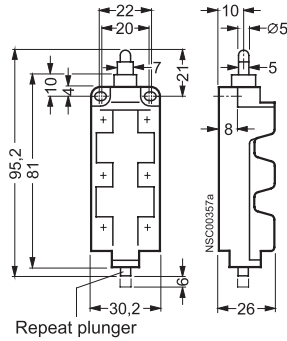

Repeat plunger