

ISOLATED HERMETIC TO-257AA FIXED VOLTAGE REGULATORS

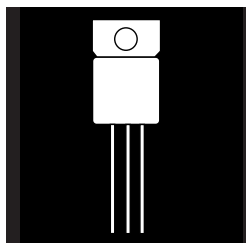

Three Terminal, Fixed Voltage, 1.5 Amp Precision Positive Regulators In Hermetic JEDEC TO-257AA Package

FEATURES

- Isolated Hermetic Package, JEDEC TO-257AA Outline
- Output Voltages: 5V, 12V, 15V (Other Voltages Available)
- Output Voltages Set Internally To $\pm 1\%$ or $\pm 2\%$
- Built-In Thermal Overload Protection
- Short Circuit Current Limiting
- Product Is Available Screened To OM803

DESCRIPTION

These three terminal positive regulators are supplied in a hermetically sealed metal package whose outline is similar to the industry standard TO-220 plastic package. All protective features are designed into the circuit including thermal shutdown, current limiting and safe-area control. With heat sinking, they can deliver over 1.5 amps of output current. These units feature internally trimmed output voltages to $\pm 1\%$ or $\pm 2\%$ of nominal voltage. Standard voltages are 5V, 12V, and 15V. However, other voltages are available up to 24 volts. These units are ideally suited for Military applications where a hermetically sealed package is required.

ABSOLUTE MAXIMUM RATINGS @ 25°C

Input Voltage.....	35 V
Operating Junction Temperature Range	- 55°C to + 150°C
Storage Temperature Range	- 65°C to + 150°C
Typical Power/Thermal Characteristics:	
Rated Power @ 25° C	T_C 17.5W
	T_A 3W
Thermal Resistance	
	θ_{JC} 4.2°C/W
	θ_{JA} 42°C/W

3.3

Notes: Product also available in Non-Isolated construction. To order this version, delete "I" from part number.

Example:	<u>Isolated</u>	<u>Non-Isolated</u>
	OM78XXIH	OM78XXH

Use letter "A" after part number to designate $\pm 1\%$ output voltage tolerance.

Example: OM7805AIH

OM7800IH Series

ELECTRICAL CHARACTERISTICS 5 Volt $V_{IN} = 10V, I_o = 500mA, -55^{\circ}C \leq T_A \leq 125^{\circ}C$ (unless otherwise specified)

Parameter	Symbol	Test Conditions	Min.	Max.	Unit
Output Voltage	V_{OUT}	$T_A = 25^{\circ}C$	4.92	5.08	V
		$V_{IN} = 7.5V$ to 20V	• 4.85	5.15	V
Line Regulation (Note 1)	V_{RLINE}	$V_{IN} = 7.5V$ to 20V		5	mV
		$V_{IN} = 8.0V$ to 12V	•	12	mV
Load Regulation (Note 1)	V_{RLOAD}	$I_o = 5mA$ to 1.5 Amp	•	4	mV
		$I_o = 250mA$ to 750 mA	•	10	mV
Standby Current Drain	I_{SCD}		•	12	mV
			•	25	mV
Standby Current Drain Change With Line	$D I_{SCD}$ (Line)	$V_{IN} = 7.5V$ to 20V	•	6	mA
			•	6.5	mA
Standby Current Drain Change With Load	$D I_{SCD}$ (Load)	$I_o = 5mA$ to 1000mA	•	0.8	mA
			•	0.5	mA
Dropout Voltage	V_{DO}	$T_A = 25^{\circ}C, DV_{OUT} = 100mV, I_o = 1.0A$		2.5	V
Peak Output Current	$I_{O(pk)}$	$T_A = 25^{\circ}C$	1.5	3.3	A
Short Circuit Current (Note 2)	I_{DS}	$V_{IN} = 35V$		1.2	A
			•	2.8	A
Ripple Rejection	$\frac{DV_{IN}}{DV_{OUT}}$	$f = 120Hz, DV_{IN} = 10V$		66	dB
		(Note 3)	•	60	dB
Output Noise Voltage (Note 3)	N_O	$T_A = 25^{\circ}C, f = 10Hz$ to 100KHz		40	$\mu V/V$ RMS
Long Term Stability (Note 3)	$\frac{DV_{OUT}}{DT}$	$T_A = 25^{\circ}C, t = 1000$ hrs.		75	mV

ELECTRICAL CHARACTERISTICS 12 Volt $V_{IN} = 19V, I_o = 500mA, -55^{\circ}C \leq T_A \leq 125^{\circ}C$ (unless otherwise specified)

Parameter	Symbol	Test Conditions	Min.	Max.	Unit
Output Voltage	V_{OUT}	$T_A = 25^{\circ}C$	11.88	12.12	V
		$V_{IN} = 14.5V$ to 27V	• 11.64	12.36	V
Line Regulation (Note 1)	V_{RLINE}	$V_{IN} = 14.5V$ to 27V	•	18	mV
		$V_{IN} = 16V$ to 22V	•	50	mV
Load Regulation (Note 1)	V_{RLOAD}	$I_o = 5mA$ to 1.5 Amp	•	9	mV
		$I_o = 250mA$ to 750 mA	•	30	mV
Standby Current Drain	I_{SCD}		•	32	mV
			•	60	mV
Standby Current Drain Change With Line	$D I_{SCD}$ (Line)	$V_{IN} = 15V$ to 30V	•	20	mV
			•	40	mV
Standby Current Drain Change With Load	$D I_{SCD}$ (Load)	$I_o = 5mA$ to 1000mA	•	0.5	mA
			•	0.5	mA
Dropout Voltage	V_{DO}	$DV_{OUT} = 100mV, I_o = 1.0A$	•	2.5	V
Peak Output Current	$I_{O(pk)}$	$T_A = 25^{\circ}C$	1.5	3.3	A
Short Circuit Current (Note 2)	I_{DS}	$V_{IN} = 35V$		1.2	A
			•	2.8	A
Ripple Rejection	$\frac{DV_{IN}}{DV_{OUT}}$	$f = 120Hz, DV_{IN} = 10V$		61	dB
		(Note 3)	•	54	dB
Output Noise Voltage (Note 3)	N_O	$T_A = 25^{\circ}C, f = 10Hz$ to 100KHz		40	$\mu V/V$ RMS
Long Term Stability (Note 3)	$\frac{DV_{OUT}}{DT}$	$T_A = 25^{\circ}C, t = 1000$ hrs.		120	mV

Notes:

- Load and Line Regulation are specified at a constant junction temperature. Pulse testing with low duty cycle is used. Changes in output voltage due to heating effects must be taken into account separately.
- Short Circuit protection is only assured up to $V_{IN} = 35V$.
- If not tested, shall be guaranteed to the specified limits.

The • denotes the specifications which apply over the full operating temperature range.

OM7800IH Series

ELECTRICAL CHARACTERISTICS 15 Volt $V_{IN} = 23V, I_O = 500mA, -55^{\circ}C \leq T_A \leq 125^{\circ}C$ (unless otherwise specified)

Parameter	Symbol	Test Conditions	Min.	Max.	Unit
Output Voltage	V_{OUT}	$T_A = 25^{\circ}C$	14.8	15.2	V
		$V_{IN} = 18.5V$ to $30V$	• 14.6	15.4	V
Line Regulation (Note 1)	V_{RLINE}	$V_{IN} = 17.5V$ to $30V$	•	20	mV
		$V_{IN} = 20V$ to $26V$	•	50	mV
			•	15	mV
Load Regulation (Note 1)	V_{RLOAD}	$I_O = 5mA$ to 1.5 Amp	•	35	mV
		$I_O = 5mA$ to 1.0 Amp	•	75	mV
		$I_O = 250mA$ to 750 mA	•	21	mV
Standby Current Drain	I_{SCD}		•	6.0	mA
			•	6.5	mA
Standby Current Drain Change With Line	DI_{SCD} (Line)	$V_{IN} = 18.5V$ to $30V$	•	0.8	mA
Standby Current Drain Change With Load	DI_{SCD} (Load)	$I_O = 5mA$ to $1000mA$	•	0.5	mA
Dropout Voltage	V_{DO}	$T_A = 25^{\circ}C, DV_{OUT} = 100mV, I_O = 1.0A$		2.5	V
Peak Output Current	$I_{O(pk)}$	$T_A = 25^{\circ}C$	1.5	3.3	A
Short Circuit Current (Note 2)	I_{DS}	$V_{IN} = 35V$	•	1.2	A
			•	2.8	A
Ripple Rejection	DV_{IN} DV_{OUT}	$f = 120$ Hz, $DV_{IN} = 10V$	•	54	dB
		(Note 3)	•	52	dB
Output Noise Voltage (Note 3)	N_O	$T_A = 25^{\circ}C, f = 10$ Hz to $100KHz$		40	$\mu V/V$ RMS
Long Term Stability (Note 3)	DV_{OUT} Dt	$T_A = 25^{\circ}C, t = 1000$ hrs.		150	mV

Notes:

1. Load and Line Regulation are specified at a constant junction temperature. Pulse testing with low duty cycle is used. Changes in output voltage due to heating effects must be taken into account separately.
 2. Short Circuit protection is only assured up to $V_{IN} = 35V$.
 3. If not tested, shall be guaranteed to the specified limits.
- The • denotes the specifications which apply over the full operating temperature range.

TYPICAL PERFORMANCE CHARACTERISTICS

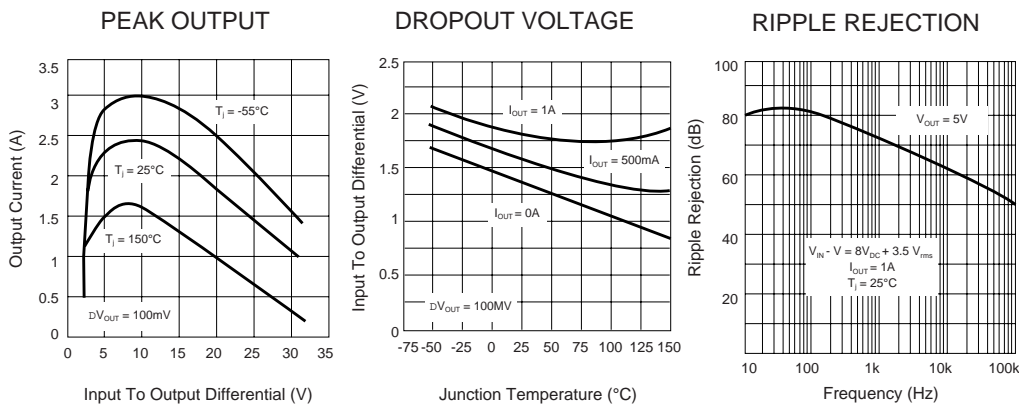

3.3

OM7800IH Series

TYPICAL APPLICATIONS

Fixed Output Regulator

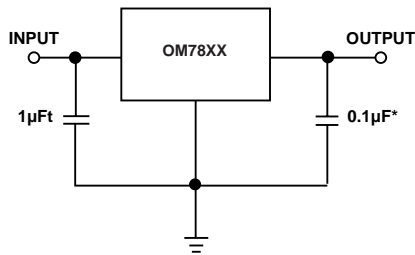

*Increasing value of output capacitor improves system transient response.
 †Required only if regulator is located an appreciable distance from power supply filter.

Circuit For Increasing Output Voltage

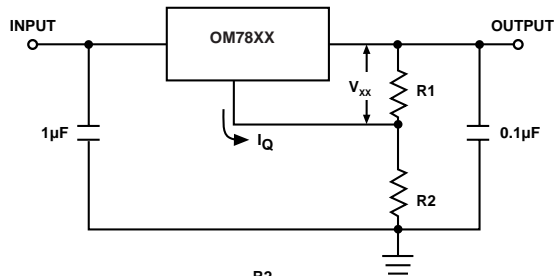

$$V_O = V_{XX} \left(1 + \frac{R_2}{R_1}\right) + I_Q R_2$$

High Output Current, Short Circuit Protected

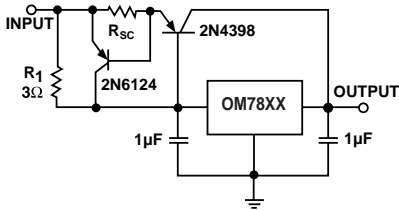

Adjustable Output Regulator, 7 To 30 Volts

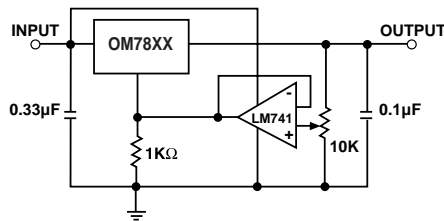

MECHANICAL OUTLINE

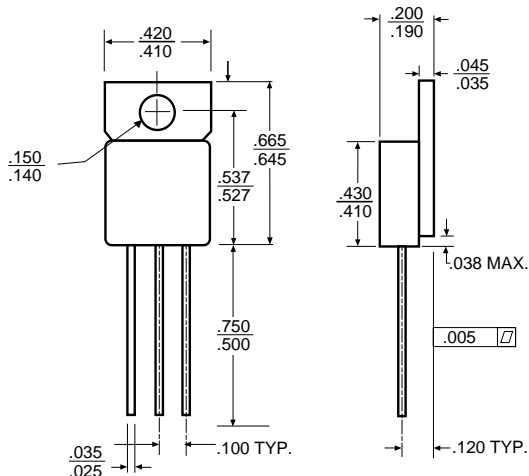

PIN CONNECTION

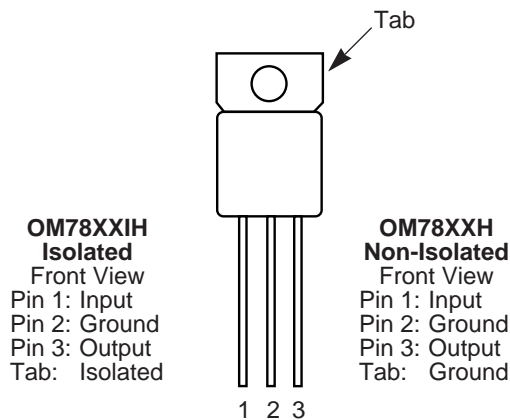

Note:

- Case is metal/hermetically sealed
- Isolated Tab

3.3