

# 7MBP150RA060

## IGBT-IPM R series

600V / 150A 7 in one-package

### Features

- Temperature protection provided by directly detecting the junction temperature of the IGBTs
- Low power loss and soft switching
- Compatible with existing IPM-N series packages
- High performance and high reliability IGBT with overheating protection
- Higher reliability because of a big decrease in number of parts in built-in control circuit

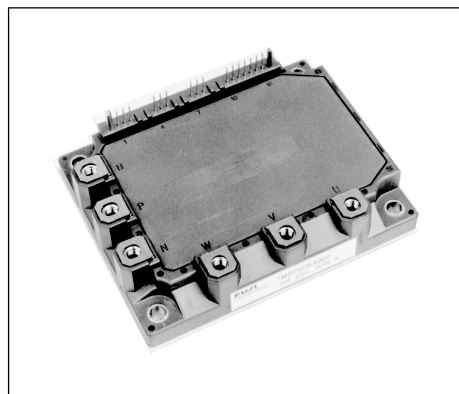

### Maximum ratings and characteristics

- Absolute maximum ratings (at  $T_c=25^\circ\text{C}$  unless otherwise specified)

| Item   | Symbol                      | Rating         |          | Unit             |     |   |
|--|-----------------------------|----------------|----------|------------------|-----|---|
|  |                             | Min.           | Max.     |                  |     |   |
| DC bus voltage                               | $V_{DC}$                    | 0              | 450      | V                |     |   |
| DC bus voltage (surge)                       | $V_{DC(surge)}$             | 0              | 500      | V                |     |   |
| DC bus voltage (short operating)             | $V_{SC}$                    | 200            | 400      | V                |     |   |
| Collector-Emitter voltage                    | $V_{CES}$                   | 0              | 600      | V                |     |   |
| DB Reverse voltage                           | $V_R$                       | 0              | 600      | V                |     |   |
| INV  | Collector current           | DC             | $I_C$    | -                | 150 | A |
|  |                             | 1ms            | $I_{CP}$ | -                | 300 | A |
|  |                             | DC             | $-I_C$   | -                | 150 | A |
|  | Collector power dissipation | One transistor | $P_C$    | -                | 595 | W |
| DB   | Collector current           | DC             | $I_C$    | -                | 50  | A |
|  |                             | 1ms            | $I_{CP}$ | -                | 100 | A |
|  | Forward current of Diode    |                | $I_F$    | -                | 50  | A |
|  | Collector power dissipation | One transistor | $P_C$    | -                | 198 | W |
| Junction temperature                         | $T_j$                       | -              | 150      | $^\circ\text{C}$ |     |   |
| Input voltage of power supply for Pre-Driver | $V_{CC}^{*1}$               | 0              | 20       | V                |     |   |
| Input signal voltage                         | $V_{in}^{*2}$               | 0              | $V_Z$    | V                |     |   |
| Input signal current                         | $I_{in}$                    | -              | 1        | mA               |     |   |
| Alarm signal voltage                         | $V_{ALM}^{*3}$              | 0              | $V_{CC}$ | V                |     |   |
| Alarm signal current                         | $I_{ALM}^{*4}$              | -              | 15       | mA               |     |   |
| Storage temperature                          | $T_{stg}$                   | -40            | 125      | $^\circ\text{C}$ |     |   |
| Operating case temperature                   | $T_{op}$                    | -20            | 100      | $^\circ\text{C}$ |     |   |
| Isolating voltage (Case-Terminal)            | $V_{iso}^{*5}$              | -              | AC2.5    | kV               |     |   |
| Screw torque                                 | Mounting (M5)               | -              | 3.5 *6   | N·m              |     |   |
|  | Terminal (M5)               | -              | 3.5 *6   | N·m              |     |   |

\*1 Apply  $V_{CC}$  between terminal No. 3 and 1, 6 and 4, 9 and 7, 11 and 10.

\*2 Apply  $V_{in}$  between terminal No. 2 and 1, 5 and 4, 8 and 7, 12,13,14,15 and 10.

\*3 Apply  $V_{ALM}$  between terminal No. 16 and 10.

\*4 Apply  $I_{ALM}$  to terminal No. 16.

\*5 50Hz/60Hz sine wave 1 minute.

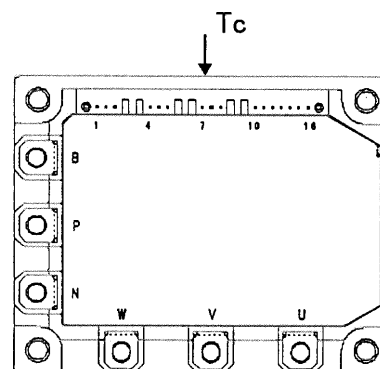

Fig.1 Measurement of case temperature

- Electrical characteristics of power circuit (at  $T_c=T_j=25^\circ\text{C}$ ,  $V_{CC}=15\text{V}$ )

| Item | Symbol                                | Condition     | Min.                                     | Typ. | Max. | Unit |    |
|------|---------------------------------------|---------------|--|------|------|------|----|
| INV  | Collector current at off signal input | $I_{CES}$     | $V_{CE}=600\text{V}$ input terminal open | -    | -    | 1.0  | mA |
|      | Collector-Emitter saturation voltage  | $V_{CE(sat)}$ | $I_C=150\text{A}$                        | -    | -    | 2.8  | V  |
|      | Forward voltage of FWD                | $V_F$         | $-I_C=150\text{A}$                       | -    | -    | 3.0  | V  |
| DB   | Collector current at off signal input | $I_{CES}$     | $V_{CE}=600\text{V}$ input terminal open | -    | -    | 1.0  | mA |
|      | Collector-Emitter saturation voltage  | $V_{CE(sat)}$ | $I_C=50\text{A}$                         | -    | -    | 2.8  | V  |
|      | Forward voltage of Diode              | $V_F$         | $-I_C=50\text{A}$                        | -    | -    | 3.3  | V  |

● Electrical characteristics of control circuit(at  $T_c=T_j=25^\circ\text{C}$ ,  $V_{cc}=15\text{V}$ )

| Item   | Symbol       | Condition   | Min.                                      | Typ. | Max. | Unit             |   |
|--|--------------|---|---|------|------|------------------|---|
| Power supply current of P-line side Pre-driver(one unit) | $I_{ccp}$    | $f_{sw}=0$ to 15kHz $T_c=-20$ to $100^\circ\text{C}$ *7       | 3   | -    | 18   | mA               |   |
| Power supply current of N-line side three Pre-driver     | $I_{ccn}$    | $f_{sw}=0$ to 15kHz $T_c=-20$ to $100^\circ\text{C}$ *7       | 10  | -    | 65   | mA               |   |
| Input signal threshold voltage (on/off)                  | $V_{in(th)}$ | ON  | 1.00                                      | 1.35 | 1.70 | V                |   |
|  |              | OFF   | 1.25                                      | 1.60 | 1.95 | V                |   |
| Input zener voltage                                      | $V_z$        | $R_{in}=20\text{k ohm}$                                       | -   | 8.0  | -    | V                |   |
| Over heating protection temperature level                | $T_{COH}$    | $V_{DC}=0\text{V}$ , $I_c=0\text{A}$ , Case temperature Fig.1 | 110                                       | -    | 125  | $^\circ\text{C}$ |   |
| Hysteresis   | $T_{CH}$     |   | -   | 20   | -    | $^\circ\text{C}$ |   |
| IGBT chips over heating protection temperature level     | $T_{JOH}$    | surface of IGBT chips   | 150                                       | -    | -    | $^\circ\text{C}$ |   |
| Hysteresis   | $T_{JH}$     |   | -   | 20   | -    | $^\circ\text{C}$ |   |
| Collector current protection level                       | INV          | $I_{OC}$  | $T_j=125^\circ\text{C}$ Collector current | 225  | -    | -                | A |
|  | DB           | $I_{OC}$  | $T_j=125^\circ\text{C}$ Collector current | 75   | -    | -                | A |
| Over current protection delay time                       | $t_{DOC}$    | $T_j=25^\circ\text{C}$ Fig.2                                  | -   | 10   | -    | $\mu\text{s}$    |   |
| Under voltage protection level                           | $V_{UV}$     |   | 11.0                                      | -    | 12.5 | V                |   |
| Hysteresis   | $V_H$        |   | 0.2                                       | -    | -    | V                |   |
| Alarm signal hold time                                   | $t_{ALM}$    |   | 1.5                                       | 2    | -    | ms               |   |
| SC protection delay time                                 | $t_{SC}$     | $T_j=25^\circ\text{C}$ Fig.3                                  | -   | -    | 12   | $\mu\text{s}$    |   |
| Limiting resistor for alarm                              | $R_{ALM}$    |   | 1425                                      | 1500 | 1575 | ohm              |   |

\*7 Switching frequency of IPM

● Dynamic characteristics(at  $T_c=T_j=125^\circ\text{C}$ ,  $V_{cc}=15\text{V}$ )

| Item                  | Symbol    | Condition                                | Min. | Typ. | Max. | Unit          |
|-----------------------|-----------|--|------|------|------|---------------|
| Switching time (IGBT) | $t_{on}$  | $I_C=150\text{A}$ , $V_{DC}=300\text{V}$ | 0.3  | -    | -    | $\mu\text{s}$ |
|                       | $t_{off}$ |  | -    | -    | 3.6  | $\mu\text{s}$ |
| Switching time (FWD)  | $t_{rr}$  | $I_F=150\text{A}$ , $V_{DC}=300\text{V}$ | -    | -    | 0.4  | $\mu\text{s}$ |

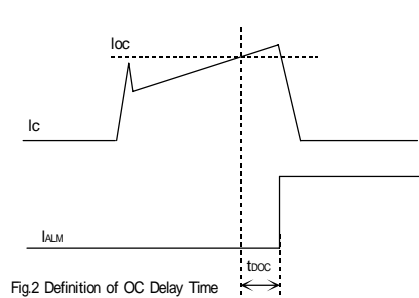

Fig.2 Definition of OC Delay Time

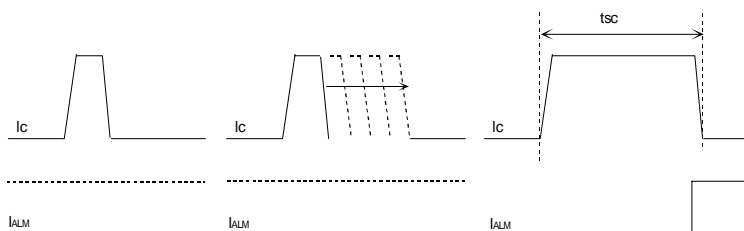

Fig.3 Definition of tsc

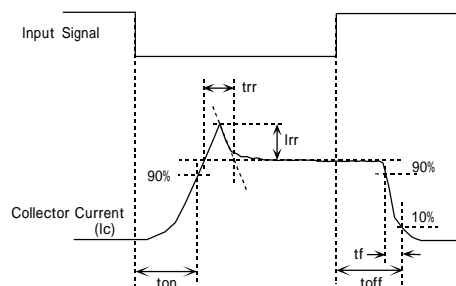

Fig.4 Definition of Switching Time

● Thermal characteristics( $T_c=25^\circ\text{C}$ )

| Item   | Symbol        | Typ. | Max.          | Unit               |      |                    |
|--|---------------|------|---------------|--------------------|------|--------------------|
| Junction to Case thermal resistance          | INV           | IGBT | $R_{th(j-c)}$ | -                  | 0.21 | $^\circ\text{C/W}$ |
|  |               | FWD  | $R_{th(j-c)}$ | -                  | 0.47 | $^\circ\text{C/W}$ |
|  | DB            | IGBT | $R_{th(j-c)}$ | -                  | 0.63 | $^\circ\text{C/W}$ |
| Case to fin thermal resistance with compound | $R_{th(c-f)}$ | 0.05 | -             | $^\circ\text{C/W}$ |      |                    |

● Recommendable value

| Item   | Symbol        | Min. | Typ. | Max. | Unit |     |
|--|---------------|------|------|------|------|-----|
| DC bus voltage                                     | $V_{DC}$      | 200  | -    | 400  | V    |     |
| Operating power supply voltage range of Pre-driver | $V_{CC}$      | 13.5 | 15   | 16.5 | V    |     |
| Switching frequency of IPM                         | $f_{sw}$      | 1    | -    | 20   | kHz  |     |
| Screw torque                                       | Mounting (M5) | -    | 2.5  | -    | 3.0  | N·m |
|  | Terminal (M5) | -    | 2.5  | -    | 3.0  | N·m |

■ **Block diagram**

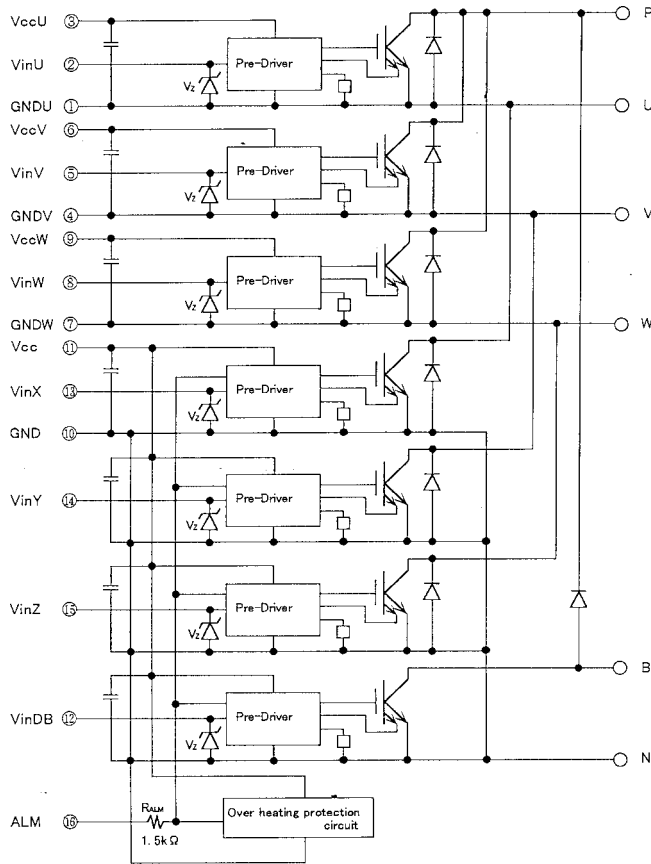

Pre-drivers include following functions  
 a) Short circuit protection circuit  
 b) Amplifier for driver  
 c) Undervoltage protection circuit  
 d) Over current protection circuit  
 e) IGBT chip over heating protection

■ **Outline drawings, mm**

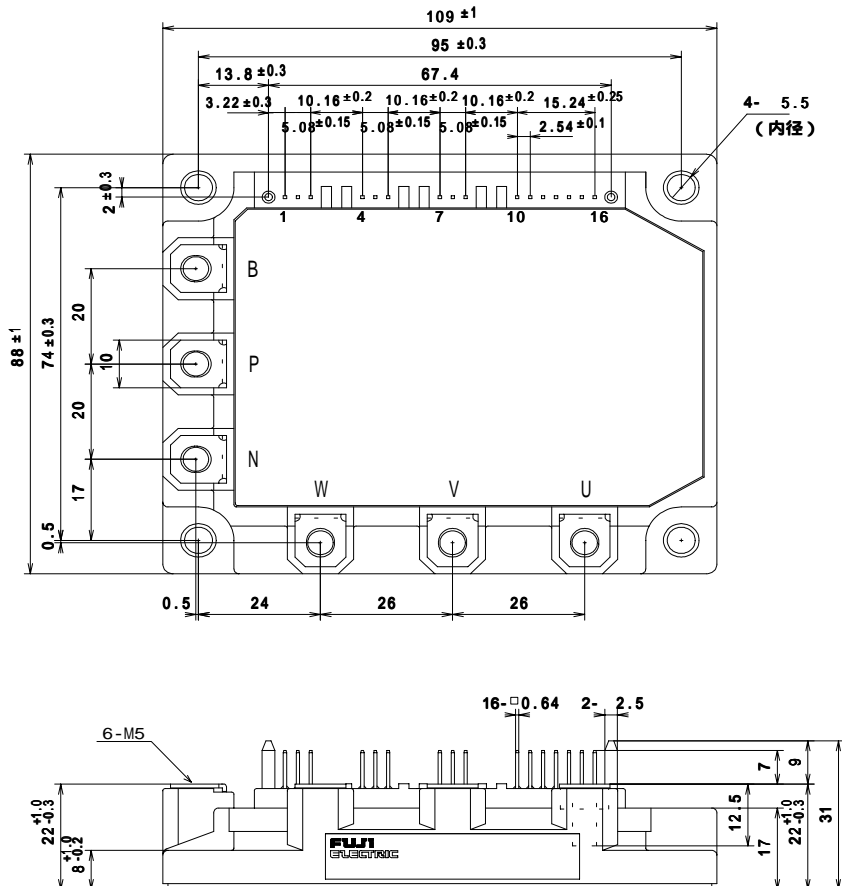

Mass : 440g

Characteristics (Representative)

Control Circuit

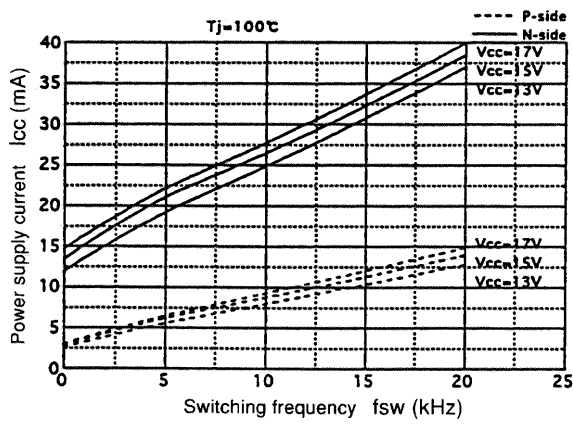

電源電流—スイッチング周波数特性  
Power supply current vs. Switching frequency

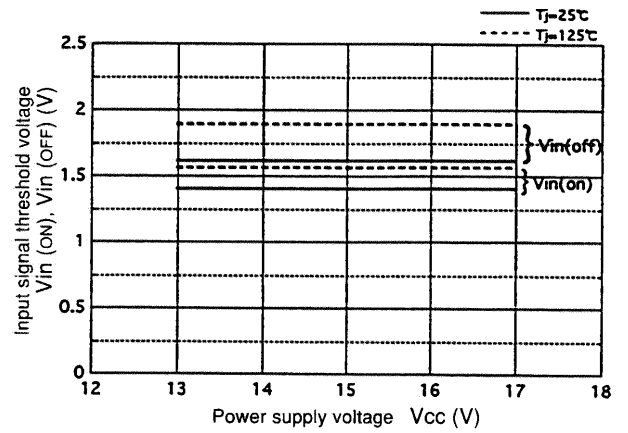

入力しきい値電圧—電源電圧特性  
Input signal threshold voltage vs. Power supply voltage

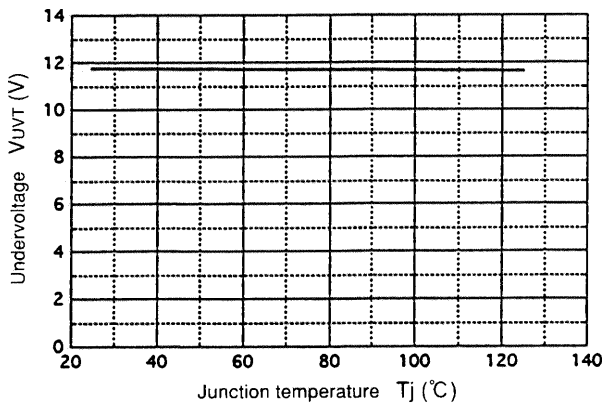

制御電源電圧低下保護レベル—接合部温度特性  
Undervoltage vs. Junction temperature

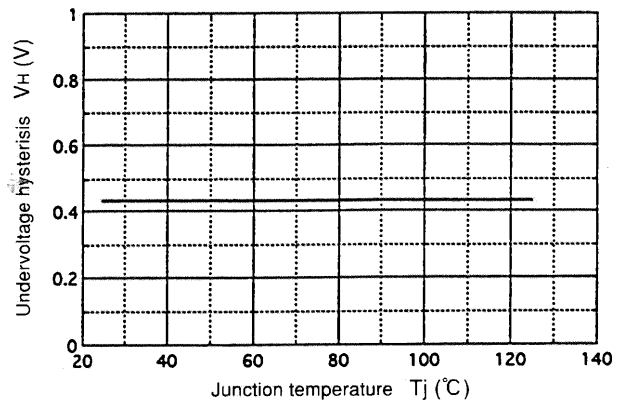

電圧低下保護ヒステリシス—接合部温度特性  
Undervoltage hysteresis vs. Junction temperature

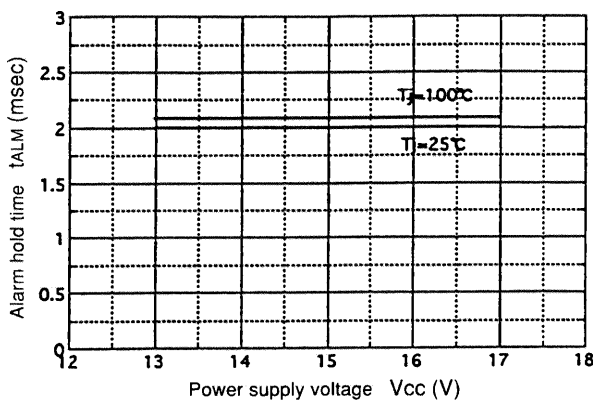

アラーム出力保持時間—電源電圧特性  
Alarm hold time vs. Power supply voltage

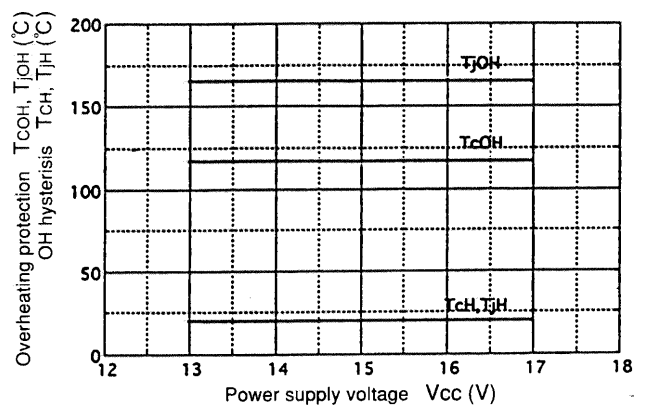

過熱保護動作温度—電源電圧特性  
Overheating characteristics TcOH, TjOH, TcH, TjH vs. Vcc

● Inverter

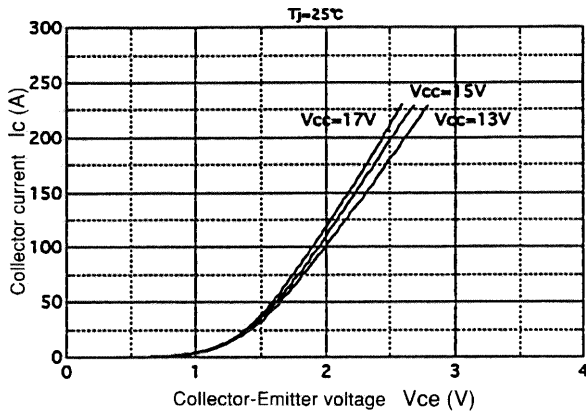

コレクタ電流—コレクタ・エミッタ間電圧特性  
 Collector current vs. Collector-Emitter voltage

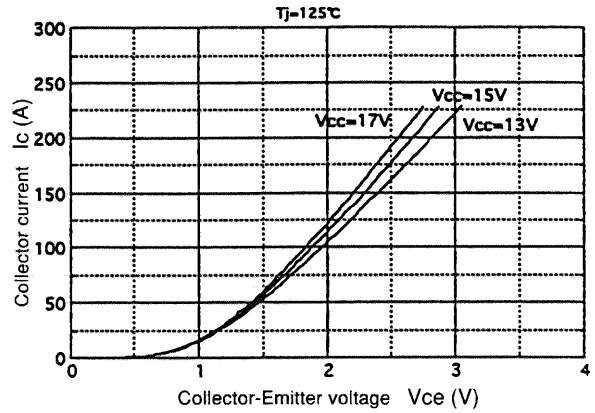

コレクタ電流—コレクタ・エミッタ間電圧特性  
 Collector current vs. Collector-Emitter voltage

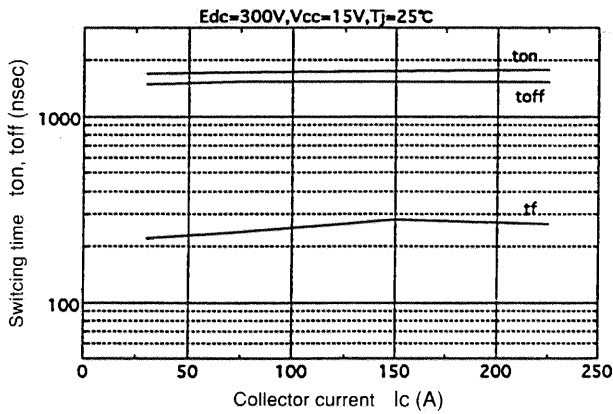

スイッチング時間—コレクタ電流特性  
 Switching time vs. Collector current

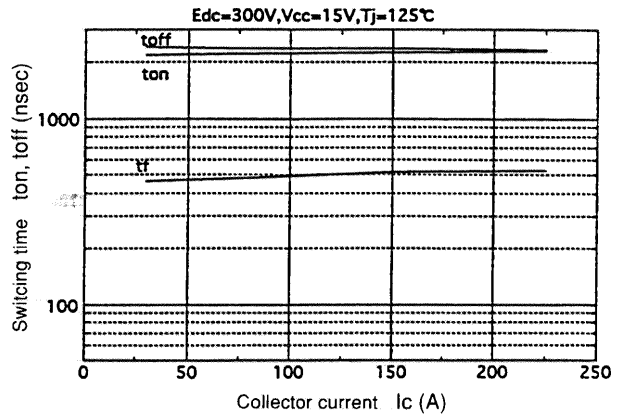

スイッチング時間—コレクタ電流特性  
 Switching time vs. Collector current

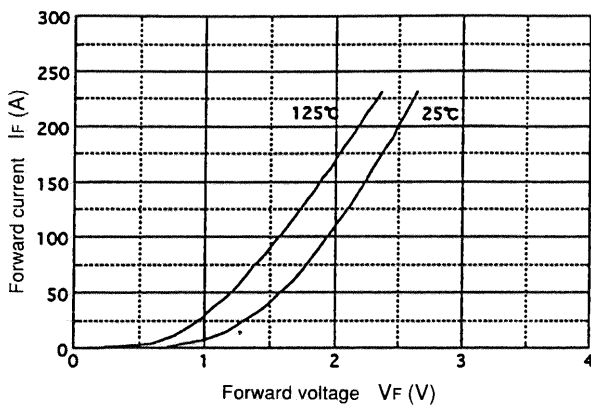

順電流—順電圧特性  
 Forward current vs. Forward voltage

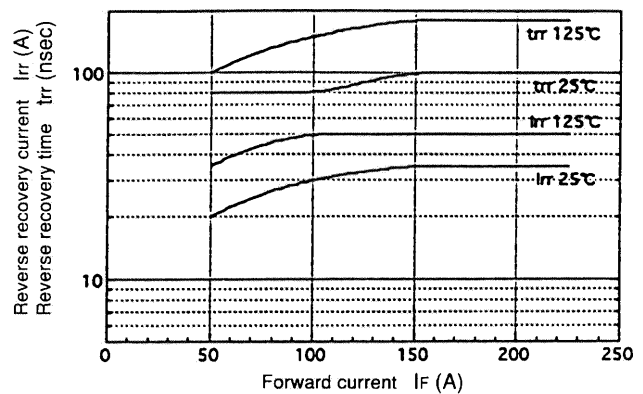

逆回復時間、逆回復電流—逆回復特性  
 Reverse recovery characteristics trr, Irr vs. IF

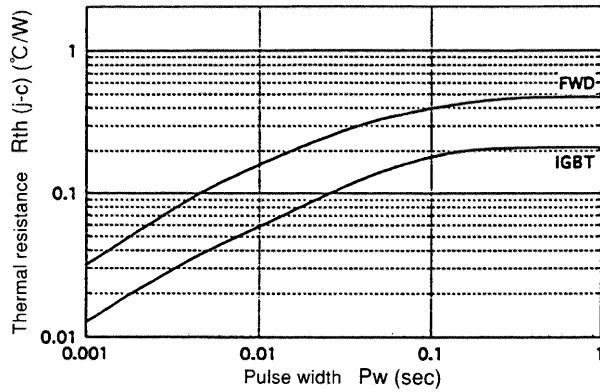

過渡熱抵抗特性  
Transient thermal resistance

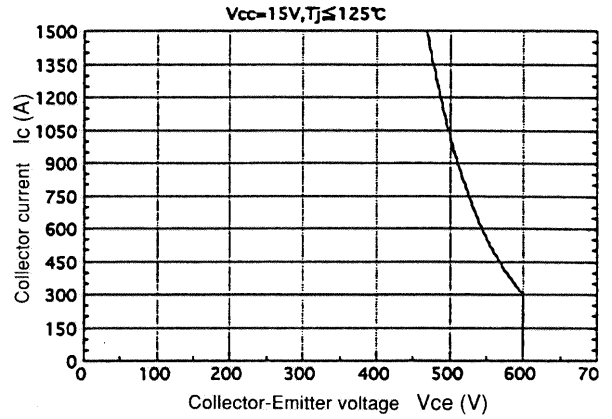

逆バイアス安全動作領域  
Reverse biased safe operating area

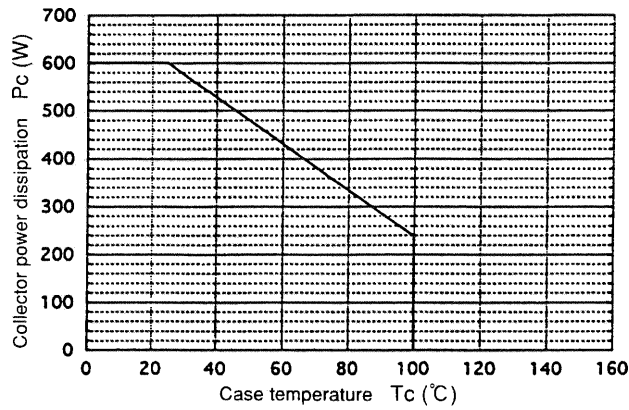

IGBT 電力低減特性 (1 チップ)  
Power derating for IGBT (per device)

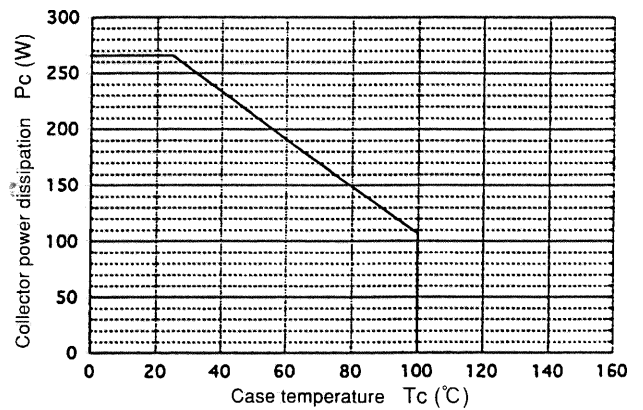

FWD 電力低減特性 (1 チップ)  
Power derating for FWD (per device)

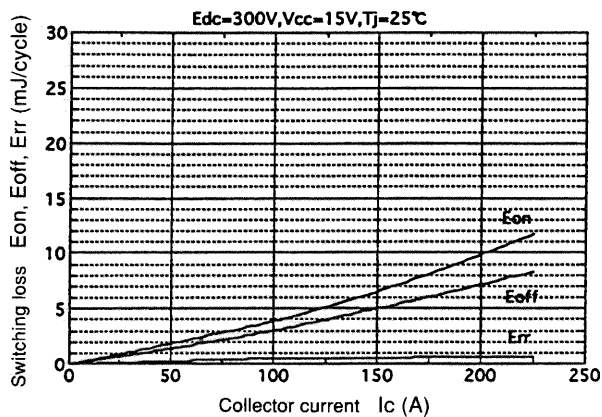

スイッチング損失—コレクタ電流特性  
Switching loss vs. Collector current

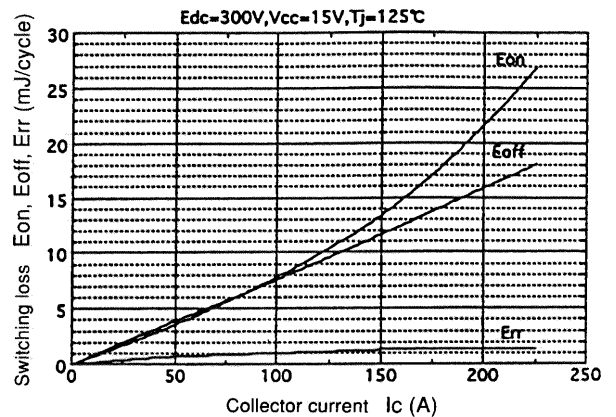

スイッチング損失—コレクタ電流特性  
Switching loss vs. Collector current

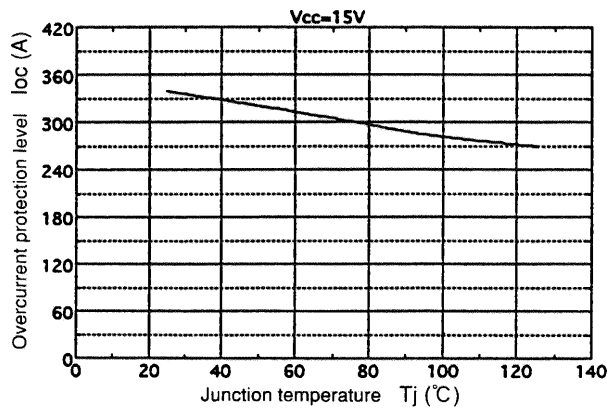

過電流保護—接合部温度特性  
Overcurrent protection vs. Junction temperature

● Brake

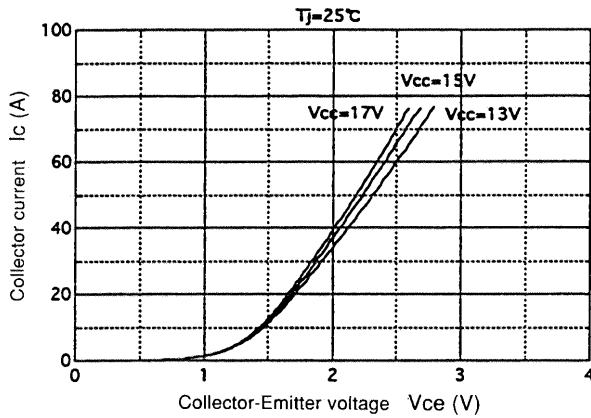

コレクタ電流—コレクタ・エミッタ間電圧特性  
Collector current vs. Collector-Emitter voltage

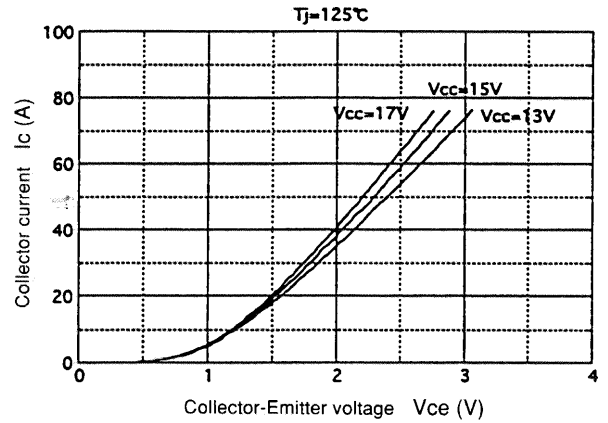

コレクタ電流—コレクタ・エミッタ間電圧特性  
Collector current vs. Collector-Emitter voltage

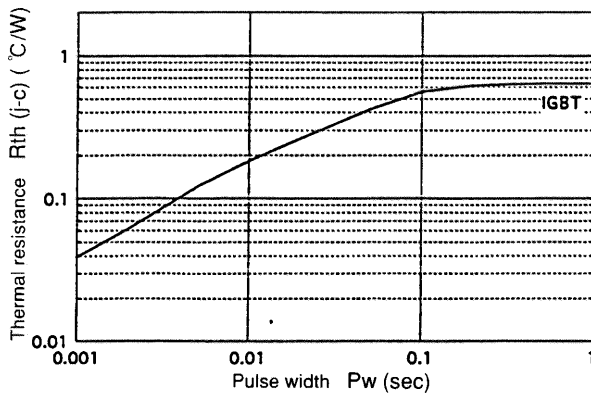

過渡熱抵抗特性  
Transient thermal resistance

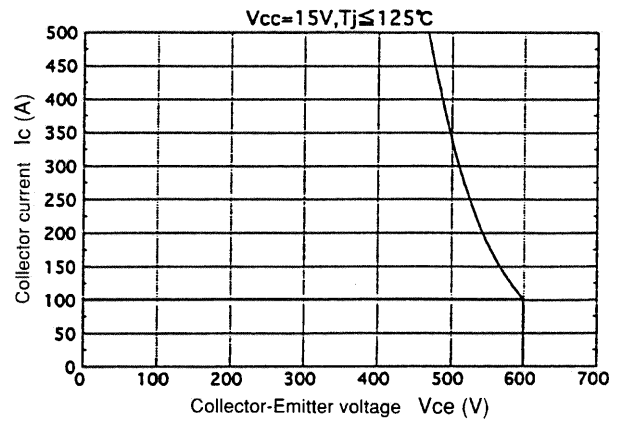

逆バイアス安全動作領域  
Reverse biased safe operating area

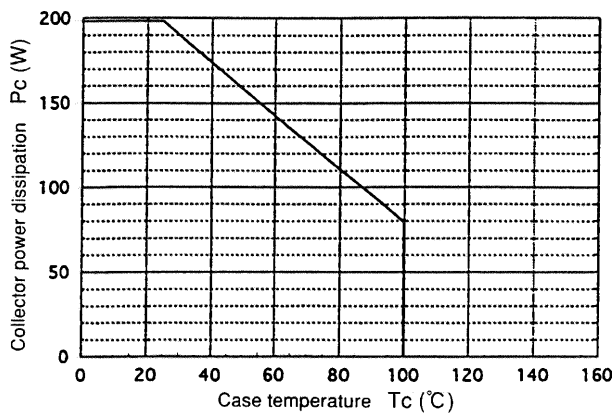

IGBT 電力低減特性  
Power derating for IGBT(per device)

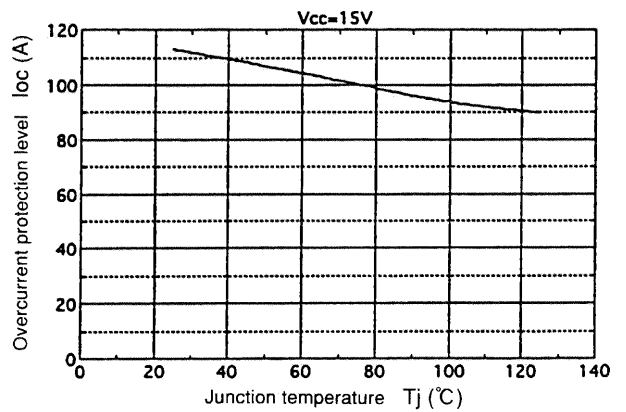

過電流保護—接合部温度特性  
Overcurrent protection vs. Junction temperature