

Color sensor module

C9303-03

RGB-LED backlight monitor for TFT-LCD (Liquid Crystal Display)

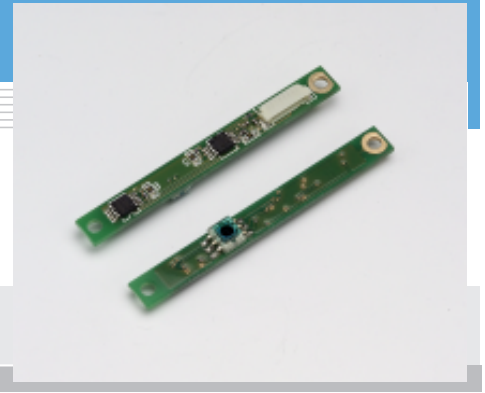

Recently, RGB-LEDs have been in the focus of attention as the backlight for TFT-LCD (liquid crystal display) since LEDs are mercury-free unlike conventional cold cathode fluorescent lamps. Hamamatsu C9303-03 color sensor module has been specifically developed for the power monitor of RGB-LEDs. We welcome requests for custom shapes and RGB gain. Feel free to contact our sales office.

Features

- Built-in RGB color sensor
Sensitivity matches wavelengths of RGB-LED backlight for TFT-LCD.
- 3 ch current-to-voltage amplifiers
Simultaneous output of 3 ch RGB photocurrent
- Configuration and size suitable for side mounting to TFT-LCD
- Suitable for lead-free solder
- Same gain and pin assignment to the conventional type C9303
- Low current consumption: 1/3 than the conventional type

Applications

- RGB-LED backlight monitor for TFT-LCD

■ Absolute maximum ratings (Ta=25 °C)

Parameter	Symbol	Value	Unit
Supply voltage	Vcc	+5.5	V
Reference voltage	VREF	Vcc - 0.4	V
Operating temperature	Topr	-20 to +85	°C
Storage temperature	Tstg	-20 to +85	°C

■ Electrical and optical characteristics (Ta=25 °C, Vcc=5.0 V, VREF=3.000 V)

Parameter	Symbol	Condition	Min.	Typ.	Max.	Unit
Photo sensitivity	SR	$\lambda_p=620$ nm	-10	-14	-	V/mW
	SG	$\lambda_p=540$ nm	-16	-20	-	
	SB	$\lambda_p=460$ nm	-13	-18	-	
Trans-impedance	ZtR	Red	-	91	-	k Ω
	ZtG	Green	-	91	-	
	ZtB	Blue	-	100	-	
Output offset voltage	Vos	Dark state	VREF-5	-	VREF+5	mV
Output voltage range	Vout		0.4	-	Vos	V
Output signal polarity *	Vout		Negative			
Output noise voltage swing	Vn	Dark state, within frequency bandwidth	-	5	-	mVp-p
Rise time	tr	10 to 90 %	-	22	-	μ s
Cut-off frequency	fc	-3 dB	-	16	-	kHz
Current consumption	Icc	Dark state	-	0.4	1.5	mA
Operating supply voltage range	Vcc		+2.7	+5	+5.5	V

* See next page graph ■ Output voltage vs. input light

■ Spectral response

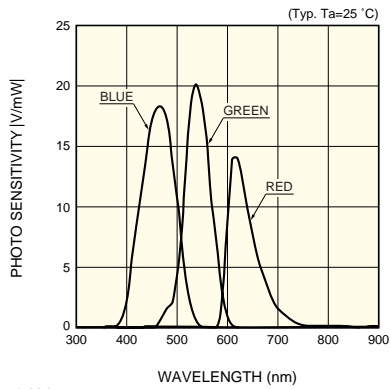

■ Output voltage vs. input light

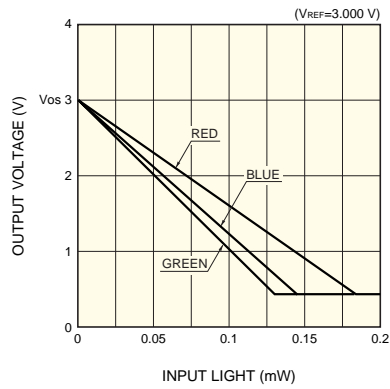

■ Block diagram

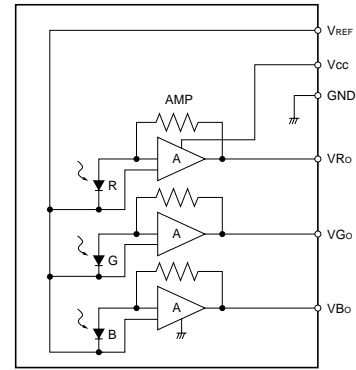

■ Dimensional outline (unit: mm)

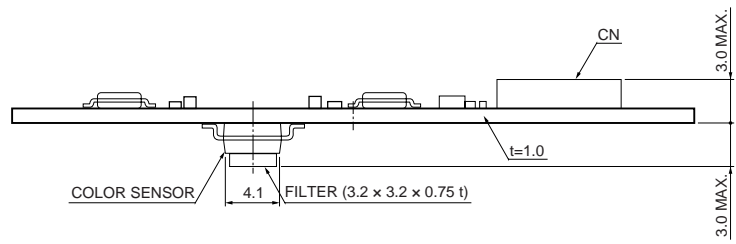
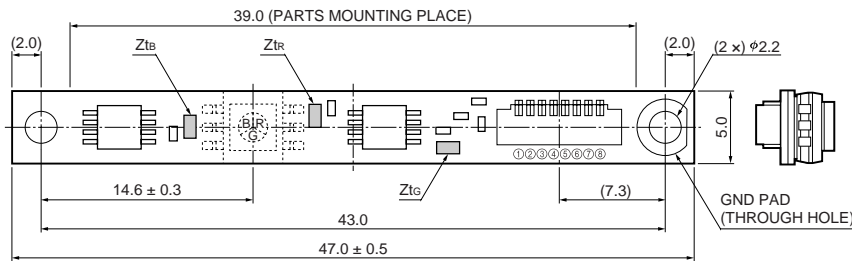

Pin No.	Signal
①	VREF
②	Vcc
③	GND
④	NC
⑤	VGo
⑥	VRo
⑦	VBo
⑧	NC

Connector: CN SM08B-SURS-TF (JST)
Mating cable: AWG#32
Tolerance unless otherwise noted: ±0.2

KACCA0160EA

■ Application example

Optical feedback of backlight for TFT-LCD

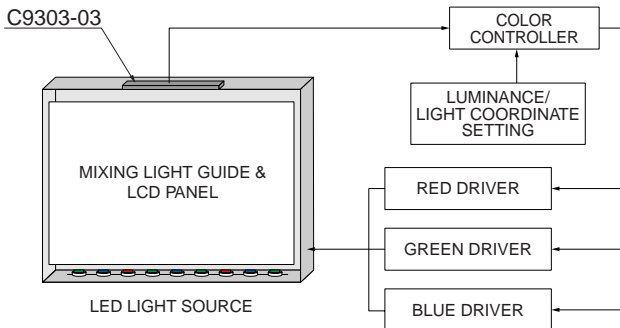

LED: Made by Lumileds (LUXEON), <http://www.lumileds.com/>

KACCC0212EC

■ Accessory

Dedicated cable with connector

HAMAMATSU

Information furnished by HAMAMATSU is believed to be reliable. However, no responsibility is assumed for possible inaccuracies or omissions. Specifications are subject to change without notice. No patent rights are granted to any of the circuits described herein. ©2006 Hamamatsu Photonics K.K.

HAMAMATSU PHOTONICS K.K., Solid State Division

1126-1 Ichino-cho, Higashi-ku, Hamamatsu City, 435-8558 Japan, Telephone: (81) 53-434-3311, Fax: (81) 53-434-5184, www.hamamatsu.com

U.S.A.: Hamamatsu Corporation: 360 Foothill Road, P.O.Box 6910, Bridgewater, N.J. 08807-0910, U.S.A., Telephone: (1) 908-231-0960, Fax: (1) 908-231-1218

Germany: Hamamatsu Photonics Deutschland GmbH: Arzbergerstr. 10, D-82211 Herrsching am Ammersee, Germany, Telephone: (49) 08152-3750, Fax: (49) 08152-2658

France: Hamamatsu Photonics France S.A.R.L.: 19, Rue du Saule Trapu, Parc du Moulin de Massy, 91882 Massy Cedex, France, Telephone: 33-(1) 69 53 71 00, Fax: 33-(1) 69 53 71 00

United Kingdom: Hamamatsu Photonics UK Limited: 2 Howard Court, 10 Tewin Road, Welwyn Garden City, Hertfordshire AL7 1BW, United Kingdom, Telephone: (44) 1707-294888, Fax: (44) 1707-325777

North Europe: Hamamatsu Photonics Norden AB: Smidesvägen 12, SE-171 41 Solna, Sweden, Telephone: (46) 8-509-031-00, Fax: (46) 8-509-031-01

Italy: Hamamatsu Photonics Italia S.R.L.: Strada della Moia, 1/E, 20020 Arese, (Milano), Italy, Telephone: (39) 02-935-81-733, Fax: (39) 02-935-81-741

www.DataSheet4U.com

Cat. No. KACC1112E03
Mar. 2006 DN