

NOT RECOMMENDED FOR NEW DESIGNS

December 1997

Pre-settable Synchronous 4-Bit Binary Up/Down Counter with Reset

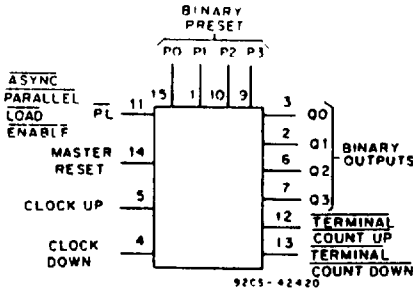

FUNCTIONAL DIAGRAM

Type Features:

- Buffered inputs
- Typical propagation delay:
11.2 ns @ $V_{CC} = 5 V, T_A = 25^\circ C, C_L = 50 pF$

The Harris CD54/74AC193 and CD54/74ACT193 are up/down binary counters with separate up/down clocks. These devices use the Harris ADVANCED CMOS technology. Presetting the counter to the number on preset data inputs (P0-P3) is accomplished by a LOW asynchronous parallel load input (PL). The counter is incremented on the LOW-to-HIGH transition of the Clock-Up input (and a HIGH level on the Clock-Down input) and decremented on the LOW-to-HIGH transition of the Clock-Down input (and a HIGH level on the Clock-Up input). A HIGH level on the Reset input overrides any other input to clear the counter to its zero state. The TCU (carry) output goes LOW half a clock period before the zero count is reached and returns to a HIGH level at the zero count. The TCD (borrow) output in the count down mode likewise goes LOW half a clock period before the maximum count (15 counts) and returns to HIGH at the maximum count. Cascading is effected by connecting the TCU and TCD outputs of a less significant counter to the Clock-Up and Clock-Down inputs, respectively, of the next most significant counter.

The CD74AC/ACT193 are supplied in 16-lead dual-in-line plastic packages (E suffix) and in 16-lead dual-in-line small-outline plastic packages (M suffix). Both package types are operable over the following temperature ranges: Commercial (0 to 70°C); Industrial (-40 to +85°C); and Extended Industrial/Military (-55 to +125°C).

The CD54AC193 and CD54ACT193, available in chip form (H suffix), are operable over the -55 to +125°C temperature range.

Family Features:

- Exceeds 2-kV ESD Protection - MIL-STD-883, Method 3015
- SCR-Latchup-resistant CMOS process and circuit design
- Speed of bipolar FAST®/AS/S with significantly reduced power consumption
- Balanced propagation delays
- AC types feature 1.5-V to 5.5-V operation and balanced noise immunity at 30% of the supply
- ± 24-mA output drive current
 - Fanout to 15 FAST® ICs
 - Drives 50-ohm transmission lines

®FAST is a Registered Trademark of Fairchild Semiconductor Corp.

TRUTH TABLE

CLOCK UP	CLOCK DOWN	RESET	PARALLEL LOAD	FUNCTION
	H	L	H	Count Up
H		L	H	Count Down
X	X	H	X	Reset
X	X	L	L	Load Preset Inputs

H = High level
L = Low level
 = Low-to-high transition
X = Don't care

CD54/74AC193

CD54/74ACT193

MAXIMUM RATINGS, Absolute-Maximum Values:

DC SUPPLY-VOLTAGE (V_{CC})	-0.5 to 6 V
DC INPUT DIODE CURRENT, I_{IK} (for $V_i < -0.5$ V or $V_i > V_{CC} + 0.5$ V)	± 20 mA
DC OUTPUT DIODE CURRENT, I_{OK} (for $V_o < -0.5$ V or $V_o > V_{CC} + 0.5$ V)	± 50 mA
DC OUTPUT SOURCE OR SINK CURRENT per Output Pin, I_o (for $V_o > -0.5$ V or $V_o < V_{CC} + 0.5$ V)	± 50 mA
DC V_{CC} or GROUND CURRENT (I_{CC} or I_{GND})	± 100 mA*
POWER DISSIPATION PER PACKAGE (P_o):	
For $T_A = -55$ to $+100^\circ\text{C}$ (PACKAGE TYPE E)	500 mW
For $T_A = +100$ to $+125^\circ\text{C}$ (PACKAGE TYPE E)	Derate Linearly at $8\text{ mW}/^\circ\text{C}$ to 300 mW
For $T_A = -55$ to $+70^\circ\text{C}$ (PACKAGE TYPE M)	400 mW
For $T_A = +70$ to $+125^\circ\text{C}$ (PACKAGE TYPE M)	Derate Linearly at $6\text{ mW}/^\circ\text{C}$ to 70 mW
OPERATING-TEMPERATURE RANGE (T_A):	-55 to $+125^\circ\text{C}$
STORAGE TEMPERATURE (T_{stg})	-65 to $+150^\circ\text{C}$
LEAD TEMPERATURE (DURING SOLDERING):	
At distance $1/16 \pm 1/32$ in. (1.59 ± 0.79 mm) from case for 10 s maximum	$+265^\circ\text{C}$
Unit inserted into PC board min. thickness $1/16$ in. (1.59 mm) with solder contacting lead tips only	$+300^\circ\text{C}$

* For up to 4 outputs per device; add ± 25 mA for each additional output.

RECOMMENDED OPERATING CONDITIONS:

For maximum reliability, normal operating conditions should be selected so that operation is always within the following ranges:

CHARACTERISTIC	LIMITS		UNITS
	MIN.	MAX.	
Supply-Voltage Range, V_{CC} *: (For $T_A =$ Full Package-Temperature Range) AC Types ACT Types	1.5 4.5	5.5 5.5	V V
DC Input or Output Voltage, V_i, V_o	0	V_{CC}	V
Operating Temperature, T_A :	-55	+125	$^\circ\text{C}$
Input Rise and Fall Slew Rate, dt/dv at 1.5 V to 3 V (AC Types) at 3.6 V to 5.5 V (AC Types) at 4.5 V to 5.5 V (ACT Types)	0 0 0	50 20 10	ns/V ns/V ns/V

*Unless otherwise specified, all voltages are referenced to ground.

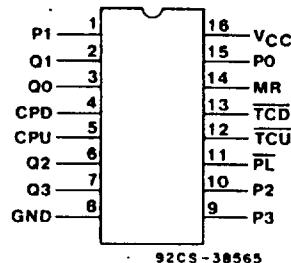

TERMINAL ASSIGNMENT

Technical Data
CD54/74AC193
CD54/74ACT193

STATIC ELECTRICAL CHARACTERISTICS: AC Series

CHARACTERISTICS	TEST CONDITIONS		V _{CC} (V)	AMBIENT TEMPERATURE (T _A) - °C						UNITS	
				+25		-40 to +85		-55 to +125			
	V _i (V)	I _o (mA)		MIN.	MAX.	MIN.	MAX.	MIN.	MAX.		
High-Level Input Voltage V _{IH}			1.5	1.2	—	1.2	—	1.2	—	V	
			3	2.1	—	2.1	—	2.1	—		
			5.5	3.85	—	3.85	—	3.85	—		
Low-Level Input Voltage V _{IL}			1.5	—	0.3	—	0.3	—	0.3	V	
			3	—	0.9	—	0.9	—	0.9		
			5.5	—	1.65	—	1.65	—	1.65		
High-Level Output Voltage V _{OH}	V _{IH} or V _{IL}	-0.05	1.5	1.4	—	1.4	—	1.4	—	V	
			3	2.9	—	2.9	—	2.9	—		
			4.5	4.4	—	4.4	—	4.4	—		
	#, * {		-4	3	2.58	—	2.48	—	2.4		—
			-24	4.5	3.94	—	3.8	—	3.7		—
			-75	5.5	—	—	3.85	—	—		—
			-50	5.5	—	—	—	—	3.85		—
Low-Level Output Voltage V _{OL}	V _{IH} or V _{IL}	0.05	1.5	—	0.1	—	0.1	—	0.1	V	
			3	—	0.1	—	0.1	—	0.1		
			4.5	—	0.1	—	0.1	—	0.1		
	#, * {		12	3	—	0.36	—	0.44	—		0.5
			24	4.5	—	0.36	—	0.44	—		0.5
			75	5.5	—	—	—	1.65	—		—
			50	5.5	—	—	—	—	—		1.65
Input Leakage Current I _I	V _{CC} or GND		5.5	—	±0.1	—	±1	—	±1	μA	
Quiescent Supply Current, MSI I _{CC}	V _{CC} or GND	0	5.5	—	8	—	80	—	160	μA	

#Test one output at a time for a 1-second maximum duration. Measurement is made by forcing current and measuring voltage to minimize power dissipation.

* Test verifies a minimum 50-ohm transmission-line-drive capability at +85°C, 75 ohms at +125°C.

CD54/74AC193

CD54/74ACT193

STATIC ELECTRICAL CHARACTERISTICS: ACT Series

CHARACTERISTICS	TEST CONDITIONS	V_{CC} (V)	AMBIENT TEMPERATURE (T_A) - °C						UNITS		
			+25		-40 to +85		-55 to +125				
			MIN.	MAX.	MIN.	MAX.	MIN.	MAX.			
High-Level Input Voltage	V_{IH}		4.5 to 5.5	2	—	2	—	2	—	V	
Low-Level Input Voltage	V_{IL}		4.5 to 5.5	—	0.8	—	0.8	—	0.8	V	
High-Level Output Voltage	V_{OH}	V_{IH} or V_{IL} #,*	-0.05	4.5	4.4	—	4.4	—	4.4	—	V
			-24	4.5	3.94	—	3.8	—	3.7	—	
			-75	5.5	—	—	3.85	—	—	—	
			-50	5.5	—	—	—	—	3.85	—	
Low-Level Output Voltage	V_{OL}	V_{IH} or V_{IL} #,*	0.05	4.5	—	0.1	—	0.1	—	0.1	V
			24	4.5	—	0.36	—	0.44	—	0.5	
			75	5.5	—	—	—	1.65	—	—	
			50	5.5	—	—	—	—	—	1.65	
Input Leakage Current	I_i	V_{CC} or GND	5.5	—	±0.1	—	±1	—	±1	µA	
Quiescent Supply Current, MSI	I_{CC}	V_{CC} or GND	0	5.5	—	8	—	80	—	160	µA
Additional Quiescent Supply Current per Input Pin TTL Inputs High 1 Unit Load	ΔI_{CC}	$V_{CC}-2.1$	4.5 to 5.5	—	2.4	—	2.8	—	3	mA	

#Test one output at a time for a 1-second maximum duration. Measurement is made by forcing current and measuring voltage to minimize power dissipation.

*Test verifies a minimum 50-ohm transmission-line-drive capability at +85°C, 75 ohms at +125°C.

ACT INPUT LOADING TABLE

INPUT	UNIT LOAD*
P0 - P3, PL	0.75
MR, CPU, CPD	0.85

*Unit load is ΔI_{CC} limit specified in Static Characteristics Chart, e.g., 2.4 mA max. @ 25°C.

Technical Data
CD54/74AC193
CD54/74ACT193

PREREQUISITE FOR SWITCHING: AC Series

CHARACTERISTICS	SYMBOL	V _{CC} (V)	AMBIENT TEMPERATURE (T _A) - °C				UNITS
			-40 to +85		-55 to +125		
			MIN.	MAX.	MIN.	MAX.	
Clock Pulse Width CPD	t _w	1.5	64	—	73	—	ns
		3.3*	7.1	—	8.1	—	
		5†	5.1	—	5.8	—	
CPU	t _w	1.5	73	—	83	—	ns
		3.3	8.1	—	9.2	—	
		5	5.8	—	6.6	—	
PL Pulse Width	t _w	1.5	66	—	75	—	ns
		3.3	7.4	—	8.4	—	
		5	5.3	—	6	—	
MR Pulse Width	t _w	1.5	55	—	63	—	ns
		3.3	6.1	—	7	—	
		5	4.4	—	5	—	
Recovery Time PL to CPU or CPD	t _{REC}	1.5	55	—	63	—	ns
		3.3	6.1	—	7	—	
		5	4.4	—	5	—	
Recovery Time MR to CPU, CPD	t _{REC}	1.5	1	—	1	—	ns
		3.3	1	—	1	—	
		5	1	—	1	—	
Setup Time Pn to PL	t _{SU}	1.5	44	—	50	—	ns
		3.3	4.9	—	5.6	—	
		5	3.5	—	4	—	
Hold Time Pn to PL	t _H	1.5	2	—	2	—	ns
		3.3	2	—	2	—	
		5	2	—	2	—	
Max. Frequency CPU	f _{max}	1.5	6.8	—	6	—	MHz
		3.3	62	—	54	—	
		5	86	—	75	—	
CPD	f _{max}	1.5	7.8	—	6.8	—	MHz
		3.3	70	—	61	—	
		5	97	—	85	—	

*3.3 V: min. is @ 3 V
†5 V: min. is @ 4.5 V

CD54/74AC193

CD54/74ACT193

SWITCHING CHARACTERISTICS: AC Series; $t_r, t_f = 3 \text{ ns}$, $C_L = 50 \text{ pF}$

CHARACTERISTICS	SYMBOL	V_{CC} (V)	AMBIENT TEMPERATURE (T_A) - °C				UNITS
			-40 to +85		-55 to +125		
			MIN.	MAX.	MIN.	MAX.	
Propagation Delays: \overline{PL} to Q_n	t_{PLH}	1.5	—	171	—	188	ns
	t_{PHL}	3.3 [*]	5.4	19.1	5.3	21	
		5 [†]	3.9	13.6	3.8	15	
CPU to Q_n CPD to Q_n	t_{PLH}	1.5	—	159	—	175	ns
	t_{PHL}	3.3	5	17.8	4.9	19.6	
		5	3.6	12.7	3.5	14	
CPU to \overline{TCU} CPD to \overline{TCU}	t_{PLH}	1.5	—	127	—	140	ns
	t_{PHL}	3.3	4	14.3	3.9	15.7	
		5	2.9	10.2	2.8	11.2	
MR to Q_n	t_{PLH}	1.5	—	182	—	200	ns
	t_{PHL}	3.3	5.8	20.4	5.6	22.4	
		5	4.1	14.5	4	16	
MR to \overline{TCU}	t_{PLH}	1.5	—	171	—	188	ns
	t_{PHL}	3.3	5.5	19.1	5.3	21	
		5	3.9	13.6	3.8	15	
MR to \overline{TCU}	t_{PLH}	1.5	—	207	—	228	ns
	t_{PHL}	3.3	6.6	23.2	6.4	25.5	
		5	4.7	16.5	4.6	18.2	
Pn to Q_n	t_{PLH}	1.5	—	187	—	206	ns
	t_{PHL}	3.3	5.9	21	5.8	23.1	
		5	4.2	15	4.1	16.5	
Power Dissipation Capacitance	$C_{PD}\S$	—	95 Typ.		95 Typ.		pF
Input Capacitance	C_I	—	—	10	—	10	pF

*3.3 V: min. is @ 3.6 V
max. is @ 3 V

†5 V: min. is @ 5.5 V
max. is @ 4.5 V

§ C_{PD} is used to determine the dynamic power consumption, per package.

$$P_D = C_{PD} V_{CC}^2 f_i + \Sigma (C_L V_{CC}^2 f_o) \text{ where } f_i = \text{input frequency}$$

$$f_o = \text{output frequency}$$

$$C_L = \text{output load capacitance}$$

$$V_{CC} = \text{supply voltage.}$$

Technical Data
CD54/74AC193
CD54/74ACT193

PREREQUISITE FOR SWITCHING: ACT Series

CHARACTERISTICS	SYMBOL	V _{CC} (V)	AMBIENT TEMPERATURE (T _A) - °C				UNITS
			-40 to +85		-55 to +125		
			MIN.	MAX.	MIN.	MAX.	
Clock Pulse Width: CPU	t _w	5†	6.8	—	7.7	—	ns
CPD			5.8	—	6.6	—	
$\overline{\text{PL}}$ Pulse Width	t _w	5	6.6	—	7.5	—	ns
MR Pulse Width	t _w	5	4.4	—	5	—	ns
Recovery Time: PL to CPU or CPD	t _{REC}	5	5.7	—	6.5	—	ns
MR to CPU, CPD			1	—	1	—	
Setup Time Pn to $\overline{\text{PL}}$	t _{su}	5	4.7	—	5.4	—	ns
Hold Time Pn to $\overline{\text{PL}}$	t _h	5	2	—	2	—	ns
Max. Frequency: CPU	f _{max}	5	74	—	65	—	MHz
CPD			86	—	75	—	

†5V min. is @ 4.5 V

SWITCHING CHARACTERISTICS: ACT Series; t_r, t_f = 3 ns, C_L = 50 pF

CHARACTERISTICS	SYMBOL	V _{CC} (V)	AMBIENT TEMPERATURE (T _A) - °C				UNITS
			-40 to +85		-55 to +125		
			MIN.	MAX.	MIN.	MAX.	
Propagation Delays: PL to Qn	t _{PLH} t _{PHL}	5†	3.9	13.6	3.8	15	ns
CPU to Qn		5	3.6	12.7	3.5	14	
CPD to Qn		5	3.6	12.7	3.5	14	
CPU to $\overline{\text{TCU}}$		5	2.9	10.2	2.8	11.2	
CPD to $\overline{\text{TCD}}$		5	2.9	10.2	2.8	11.2	
MR to Qn		5	4.1	14.5	4	16	
MR to $\overline{\text{TCU}}$		5	3.9	13.6	3.8	15	
MR to $\overline{\text{TCD}}$		5	4.7	16.5	4.6	18.2	
Pn to Qn		5	4.2	15	4.1	16.5	
Power Dissipation Capacitance	C _{PD} §	—	95 Typ.		95 Typ.		pF
Input Capacitance	C _I	—	—	10	—	10	pF

†5V: min. is @ 5.5 V
max. is @ 4.5 V.

§C_{PD} is used to determine the dynamic power consumption, per package.

$$P_D = C_{PD} V_{CC}^2 f_i + \Sigma (C_L V_{CC}^2 f_o) + V_{CC} \Delta I_{CC}$$

where f_i = input frequency
f_o = output frequency
C_L = output load capacitance
V_{CC} = supply voltage.

CD54/74AC193

CD54/74ACT193

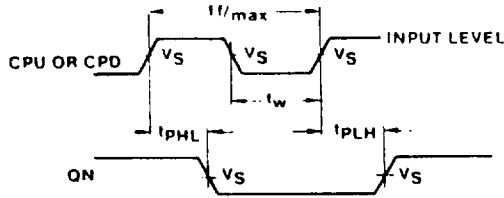

(a) Clock to output delays and clock pulse width.

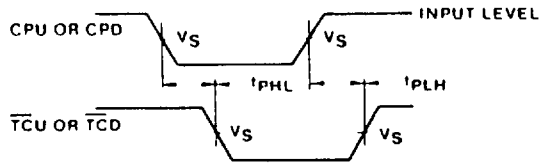

92CM-38572

(b) Clock to terminal count delays.

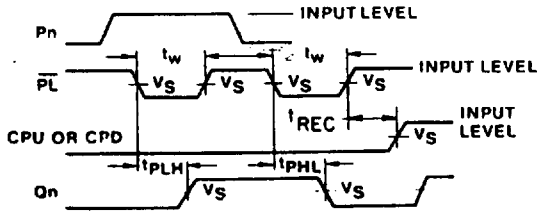

(c) Parallel load pulse width, parallel load to output delays, and parallel load to clock recovery time.

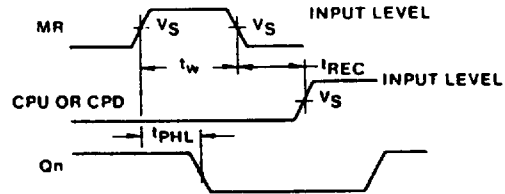

(d) Master reset pulse width, master reset to output delay and master reset to clock recovery time.

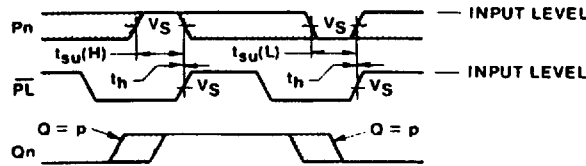

92CM-38571R2

(e) Setup and hold times data to parallel load (PL).

	CD54/74AC	CD54/74ACT
Input Level	V_{CC}	3 V
Input Switching Voltage, V_S	$0.5 V_{CC}$	1.5 V
Output Switching Voltage, V_S	$0.5 V_{CC}$	$0.5 V_{CC}$

Fig. 1 - AC waveforms.

APPLICATION

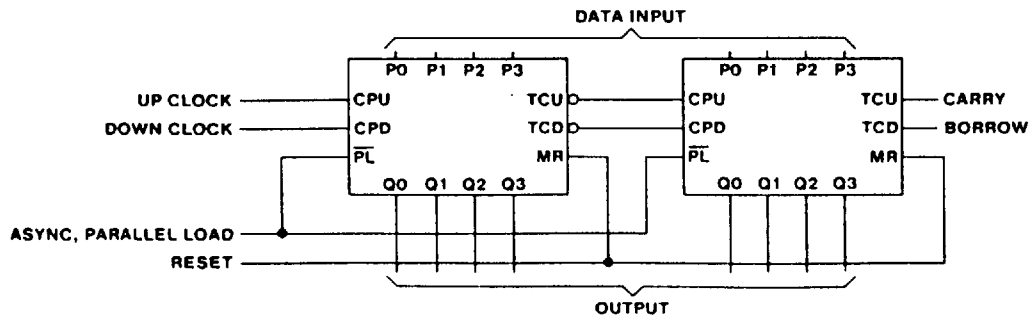

92CM-38575

CASCADED UP/DOWN COUNTER WITH PARALLEL LOAD

8

CD54/74AC193 CD54/74ACT193

Sequences:

- (1) Reset outputs to zero.
- (2) Load (preset) to binary thirteen.
- (3) Count up to fourteen, fifteen, terminal count up, zero, one and two.
- (4) Count down to one, zero, terminal count down, fifteen, fourteen and thirteen.

Note 1: Master reset overrides load data and clock inputs

Note 2: When counting up, clock-down input must be high; when counting down, clock-up input must be high.

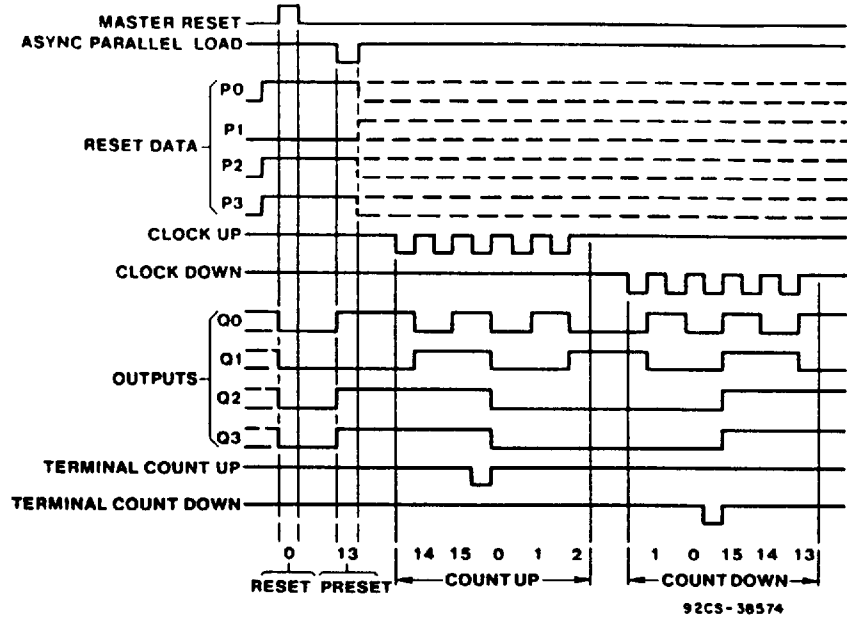

Fig. 2 - Timing diagram.