

NOT RECOMMENDED
FOR NEW DESIGNS
SEE CA3028A, B

May 1990

IF Amplifier

For Use in Communication Equipment

Features:

- Input resistance - 100 k Ω typ.
- Output resistance - 70 Ω typ.
- Voltage gain - 24 dB typ. @ 1.75 MHz
- Push-pull input, single-ended output
- -3 dB bandwidth - 11 MHz typ.
- AGC range - 80 dB typ.
- Useful frequency range DC to 15 MHz

Applications:

- Product detector
- IF & video amplifier
- AM detector
- Schmitt trigger

The CA3002 integrated-circuit IF amplifier is a balanced differential amplifier that can be used with either a single-ended or a push-pull input and can provide either a direct-coupled or a capacitance-coupled single-ended output. Its applications include RC-coupled IF amplifiers that use the internal silicon output-coupling capacitor, video amplifiers that use an external coupling capacitor, envelope detectors, product detectors, and various trigger circuits.

The CA3002 is supplied in the 10-lead hermetic TO-5 style package.

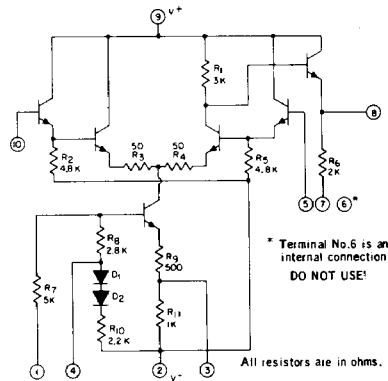

Figure 1 - Schematic diagram.

6

DIFFERENTIAL AMPLIFIERS

CA3002

ABSOLUTE-MAXIMUM VOLTAGE AND CURRENT LIMITS, at $T_A = 25^\circ\text{C}$

COMMON-MODE INPUT SIGNAL VOLTAGE	$\pm 2\text{ V}$
MAXIMUM POWER SUPPLY VOLTAGE	16 V or $\pm 8\text{ V}$
OPERATING-TEMPERATURE RANGE	-55°C to $+125^\circ\text{C}$
STORAGE-TEMPERATURE RANGE	-65°C to $+150^\circ\text{C}$
LEAD TEMPERATURE (During Soldering):	
At distance $1/16 \pm 1/32$ inch (1.59 ± 0.79 mm) from case for 10 seconds max.	$+265^\circ\text{C}$
MAXIMUM INPUT-SIGNAL VOLTAGE	$\pm 4\text{ V}$
MAXIMUM DEVICE DISSIPATION:	
-55 to 85°C	450 mW
Above 85°C	Derate linearly $5\text{ mW}/^\circ\text{C}$

ELECTRICAL CHARACTERISTICS, at $T_A = 25^\circ\text{C}$, $V_{CC} = +6\text{ V}$, $V_{EE} = -6\text{ V}$

CHARACTERISTICS	SPECIAL TEST CONDITIONS TERMINALS No. 3 & No.4 NOT CONNECTED UNLESS OTHERWISE NOTED		TEST CIRCUITS	LIMITS			U N I T S	
				CA3002				
				Fig.	Min.	Typ.		Max.
<i>STATIC CHARACTERISTICS</i>								
Input Unbalance Voltage V_{IU}			4	—	2.2	—	mV	
Input Unbalance Current I_{IU}			5	—	2.2	10	μA	
Input Bias Current I_I			5	—	20	36	μA	
Quiescent Operating Voltage	MODE	TERMINAL						
		2	4					
	A	V_{EE}	NC	7a	—	2.8	—	V
	B	V_{EE}	V_{EE}	8b	—	3.9	—	V
Device Dissipation P_T			4	—	55	—	mW	
<i>DYNAMIC CHARACTERISTICS</i>								
Differential Voltage Gain A_{DIF} (Single-Ended Input and Output)	$f = 1.75\text{ MHz}$		10	19	24	—	dB	
Bandwidth at -3 dB Point BW	—		10	—	11	—	MHz	
Maximum Output Voltage Swing $V_{OUT(P-P)}$	—		10	—	5.5	—	V_{P-P}	
Noise Figure NF	$f = 1.75\text{ MHz}$ $R_S = 1\text{ k}\Omega$		12	—	4	8	dB	
Input Impedance Components: Parallel Input Resistance R_{IN}	$f = 1.75\text{ MHz}$		None	—	100k	—	Ω	
	$f = 1.75\text{ MHz}$		None	—	4	—	μF	
Parallel Input Capacitance C_{IN}	$f = 1.75\text{ MHz}$		None	—	4	—	μF	
Output Resistance R_{OUT}	$f = 1.75\text{ MHz}$		14	—	70	—	Ω	
3rd Harmonic Intermodulation Distortion IMD	—		16	-30	-40	—	dB	
AGC Range (Maximum Voltage Gain to Complete Cutoff AGC)	$f = 1.75\text{ MHz}$		18	60	80	—	dB	

ABSOLUTE-MAXIMUM VOLTAGE AND CURRENT LIMITS, at $T_A = 25^\circ\text{C}$

Indicated voltage or current limits for each terminal can be applied under the specified operating conditions for other terminals.

All voltages are with respect to ground ($-V_{CC}$, $+V_{EE}$) or common terminal of Positive and Negative DC supplies).

TERMINAL	VOLTAGE OR CURRENT LIMITS		CONDITIONS	
	NEGATIVE	POSITIVE	TERMINAL	VOLTAGE
1	-8 V	0 V	2, 7 5, 10 9	-8 0 +6
2	-10 V	0 V	1, 5, 10 9	0 +6
3	-8.5 V	0 V	1, 5, 10 7 9	0 -6 +6
4	-8 V	0 V	1, 5, 10 2, 7 9	0 -8 +6
5	-3.5 V	+3.5 V	1, 10 2, 7 9	0 -6 +6
6	INTERNAL CONNECTION DO NOT USE			
7	-12 V	0 V	1, 5, 10 2 9	0 -6 +6
8	20 mA		1, 5, 10 2 9 200 Ω Resistor Between Terminals 7 & 8	0 -6 +6
9	0 V	+10 V	1, 5, 10 2, 3, 7	0 -6
10	-3.5 V	+3.5 V	1, 5 2, 7 9	0 -6 +6
CASE	INTERNALLY CONNECTED TO TERMINAL No.2 (SUBSTRATE) DO NOT GROUND			

6
DIFFERENTIAL
AMPLIFIERS

STATIC CHARACTERISTICS

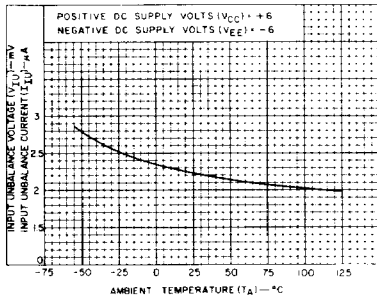

Fig. 2 - Input unbalance voltage & current vs temperature.

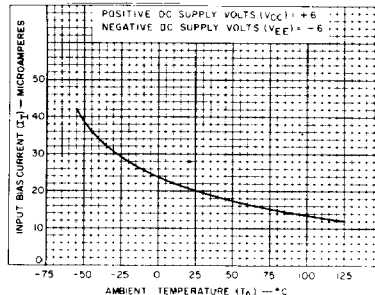

Fig. 3 - Input bias current vs temperature.

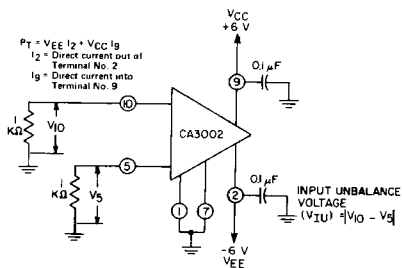

Fig. 4 - Input unbalance voltage and device dissipation test circuit.

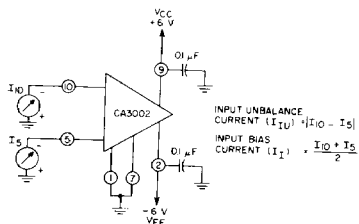

Fig. 5 - Input unbalance current & bias current test circuit.

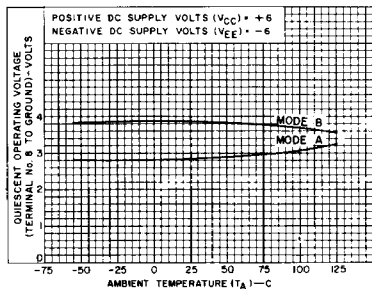

Fig. 6 - Quiescent operating voltage vs temperature.

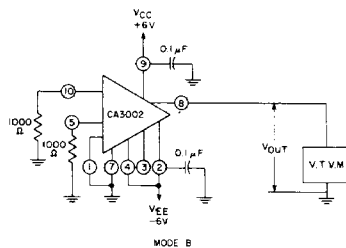
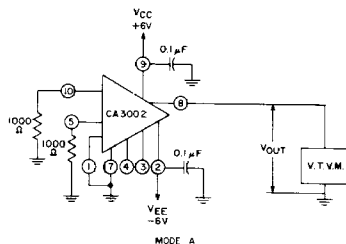

Fig. 7 - Quiescent operating voltage.

DYNAMIC CHARACTERISTICS

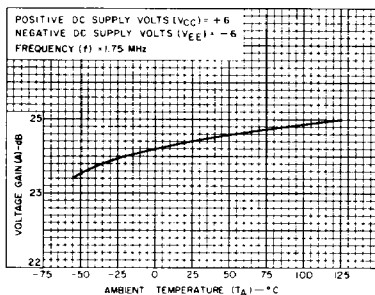

Fig. 8a - Differential voltage gain vs temperature.

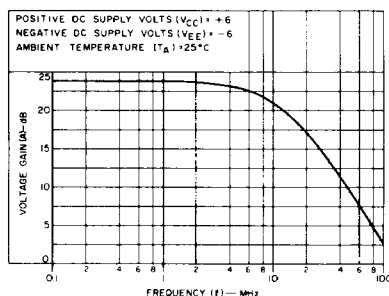

Fig. 8b - Differential voltage gain vs frequency.

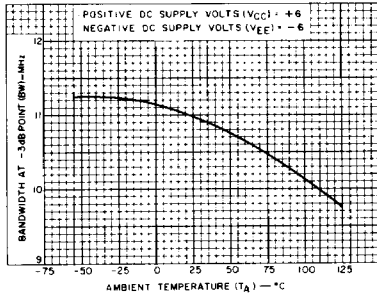

Fig. 9 - Bandwidth of -3 dB point vs temperature.

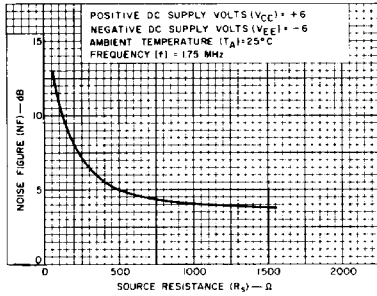

Fig. 11 - Noise figure vs source resistance.

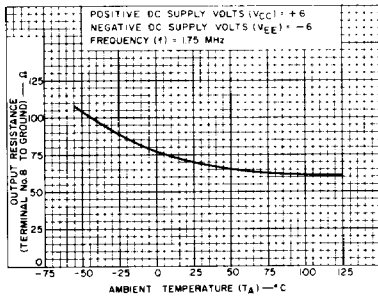

Fig. 13a - Output resistance vs temperature.

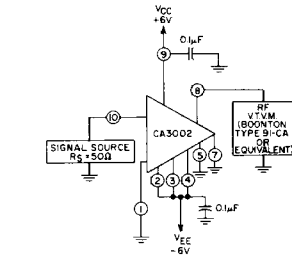
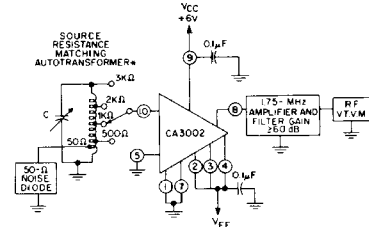

Fig. 10 - Differential voltage gain, -3 dB bandwidth, and maximum output voltage swing.



* Taps are adjusted to provide indicated equivalent values of R_s with tank tuned to resonance at 1.75 MHz, and a 50- Ω resistor connected to simulate the noise diode.

Fig. 12 - Noise figure.

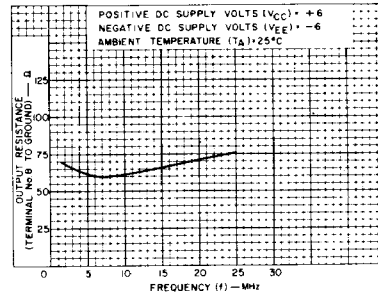

Fig. 13b - Output resistance vs frequency.

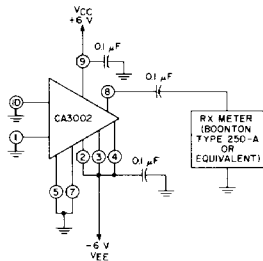

Fig. 14 - Output resistance.

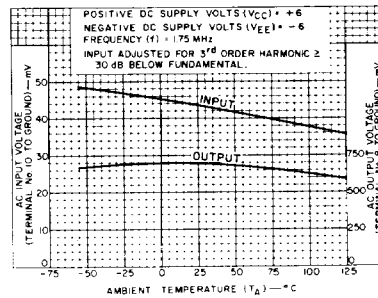
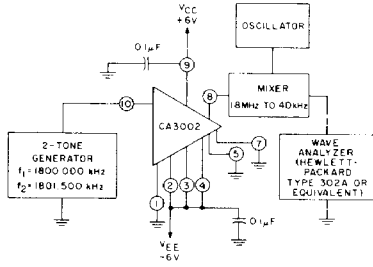

Fig. 15 - Input level for -30 dB intermodulation vs temperature.



- 1) Increase both input-signal tones until the $2f_2 - f_1$ and $2f_1 - f_2$ output-signal voltages are 30 dB below the f_1 and f_2 output-signal voltages.
- 2) Measure rms values of the input and output signal voltages.
- 3) The measured input signal voltage is that value when the 3rd-harmonic intermodulation products are 30 dB below the fundamental outputs.

Fig. 16 - Intermodulation circuit.

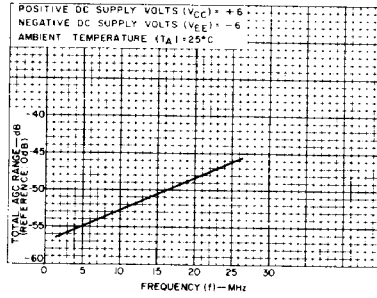
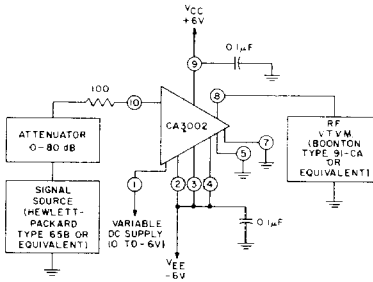

Fig. 17 - AGC range vs frequency.



- 1) Set attenuator at 80 dB attenuation.
- 2) Set variable dc supply voltage at 0 V.
- 3) Increase signal input voltage until RF V.T.V.M. indicates 5 mV output.
- 4) Set variable dc supply voltage at -6 V.
- 5) Adjust attenuator until RF V.T.V.M. again indicates 5 mV output.
- 6) Change in attenuator setting in dB is total AGC Range.

Fig. 18 - AGC range.