

UL® models available, see page C-29.

Easy Build-A-Switch:

Below is a complete listing of available options for 7000 SERIES ROCKER AND LEVER HANDLE SWITCHES. Build-A-Switch allows you to mix and match options to create the switch you need—simply select desired option from each category. Switches with standard options are shown on page C-28; all available options are shown and described on pages C-29 thru C-48. When building a part number, some ordering format boxes may not be filled. Dashes, hyphens or spaces in the part number are not significant, and are shown for clarity only. Complete HOW TO ORDER information is at the end of this section, page C-48. Hardware and accessories are available separately, see catalog section H. All models have epoxy terminal seal, and are compatible with 'bottom-wash' PC board cleaning methods.



SWITCH FUNCTION ACTUATOR TERMINATIONS CONTACT MATERIAL SEAL ACTUATOR COLOR FRAME COLOR

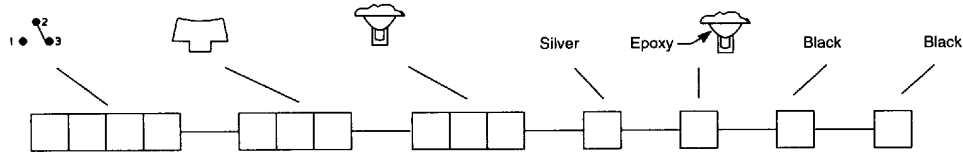

SWITCH FUNCTION	ACTUATOR	TERMINATIONS	CONTACT MATERIAL	SEAL	ACTUATOR COLOR	FRAME COLOR
7101	U11	J1	A	W	B	(NONE)
7103	U13	J2	A3	W1	G	1
7105	U15	J3	AV2	W3	K	2
7107	U17	J4	AV3	W4	L	3
7108	U18	J5	AV5	W5	M	4
7109	U19	J10	AW	Z	Q	5
7201	U21	J11	AW1	Z3		6
7203	U23	J15	AW3			8
7205	U25	J16	AW4			9
7207	U27	J19	AW5			
7208	U28	J21	C			C
7209	U29	J25	V2			S
7211	U211	J26	V3			
7213	U213	J37	V4			
7215	U215	J47	V5			
7301	U31	J50	V6			
7303	U33	J51	V7			
7305	U35	J52	V8			
7307	U37	J53	V9			
7308	U38	J54	V21			
7309	U39	J57	V31			
7401	U41	J60	V41			
7403	U43	J61	V51			
7405	U45	J62	V54			
7407	U47	J63	V55			
7408	U48	J64	V61			
7409	U49	J90	V71			
7411	U411	J91	V81			
7413	U413	J92	V91			
7415	U415	J93				
		J94				



7000 Series

Rocker and Lever Handle Switches

SWITCHES WITH STANDARD OPTIONS

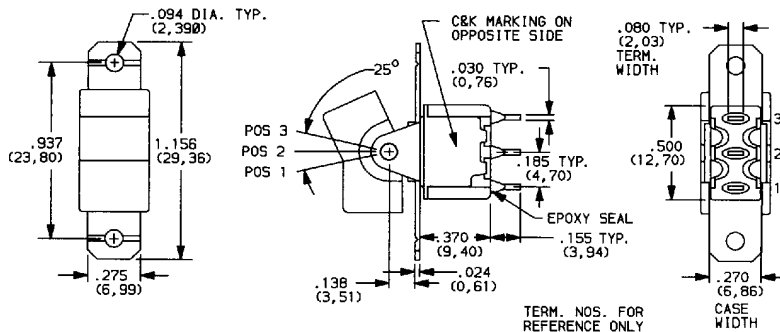
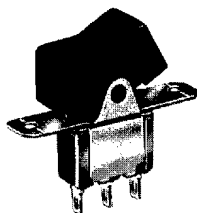

SPDT

Part No. Shown: 7101J1ZQE2

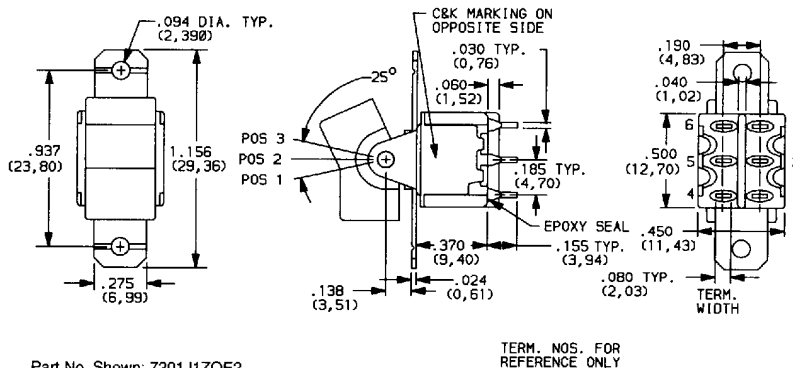
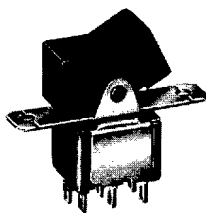

DPDT

Part No. Shown: 7201J1ZQE2

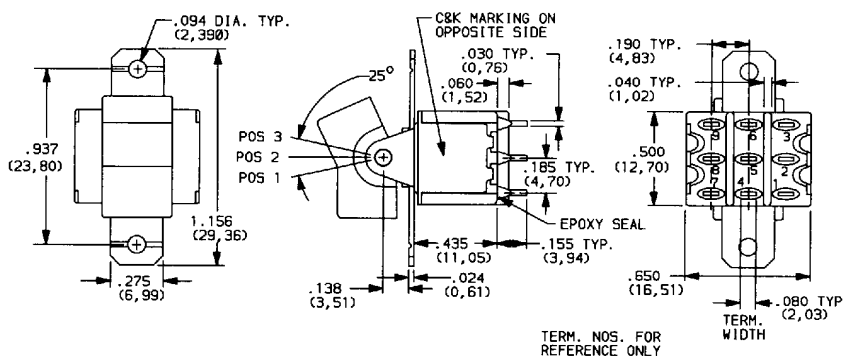
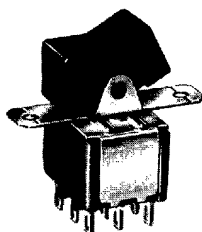

3PDT

Part No. Shown: 7301J1ZQE2

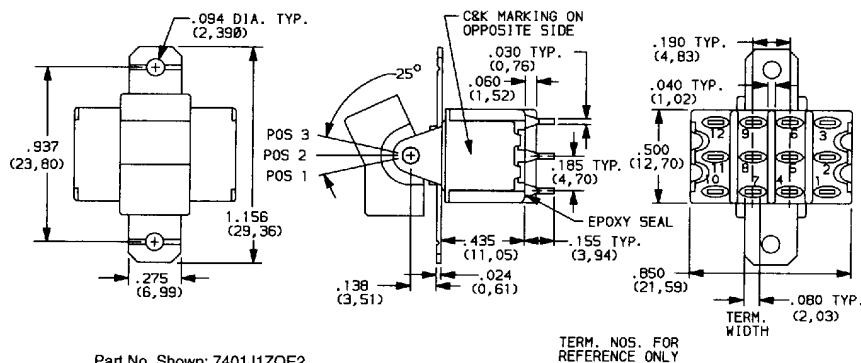
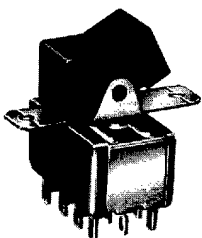

4PDT

Part No. Shown: 7401J1ZQE2

C&K COMPONENTS, INC.

57 Stanley Avenue, Watertown, MA 02172-4802

Tel: (617) 926-6400, Fax: (617) 926-6846

C-28

D 94E ■ 1760885 0004131 018 ■



7000 Series

Rocker and Lever Handle Switches

SWITCH FUNCTION

NO. POLES	MODEL NO.	UL/CSA** MODEL NO.	SWITCH FUNCTION			CONNECTED TERMINALS			SCHEMATIC			
			POS. 1	POS. 2	POS. 3	POS. 1	POS. 2	POS. 3				
SP	7101	U11	ON	NONE	ON	2-3	OPEN	2-1				
	7103	U13	ON	OFF	ON							
	7105	U15	MOM.	OFF	MOM.							
	7107	U17	ON	OFF	MOM.							
	7108	U18	ON	NONE	MOM.							
	7109	U19	NONE	ON	MOM.					N/A	2-3	2-1
DP	7201	U21	ON	NONE	ON	2-3, 5-6	OPEN	2-1, 5-4				
	7203	U23	ON	OFF	ON							
	7205	U25	MOM.	OFF	MOM.							
	7207	U27	ON	OFF	MOM.							
	7208	U28	ON	NONE	MOM.							
	7209	U29	NONE	ON	MOM.					N/A	2-3, 5-6	2-1, 5-4
	7211*	U211*	ON	ON	ON							
	7213*	U213*	ON	ON	MOM.					2-3, 5-6	2-3, 5-4	2-1, 5-4
7215*	U215*	MOM.	ON	MOM.								
3P	7301	U31	ON	NONE	ON	2-3, 5-6, 8-9	OPEN	2-1, 5-4, 8-7				
	7303	U33	ON	OFF	ON							
	7305	U35	MOM.	OFF	MOM.							
	7307	U37	ON	OFF	MOM.							
	7308	U38	ON	NONE	MOM.							
	7309	U39	NONE	ON	MOM.					N/A	2-3, 5-6, 8-9	2-1, 5-4, 8-7
4P	7401	U41	ON	NONE	ON	2-3, 5-6, 8-9, 11-12	OPEN	2-1, 5-4, 8-7, 11-10				
	7403	U43	ON	OFF	ON							
	7405	U45	MOM.	OFF	MOM.							
	7407	U47	ON	OFF	MOM.							
	7408	U48	ON	NONE	MOM.							
	7409	U49	NONE	ON	MOM.					N/A	2-3, 5-6, 8-9, 11-12	2-1, 5-4, 8-7, 11-10
	7411*	U411*	ON	ON	ON							
	7413*	U413*	ON	ON	MOM.					2-3, 5-6, 8-9, 11-12	2-3, 5-4, 8-9, 11-10	2-1, 5-4, 8-7, 11-10
7415*	U415*	MOM.	ON	MOM.								

MOM. = MOMENTARY

** U11-U415 model numbers with all options when ordered with G, L, M or Q contact material. See AGENCY APPROVALS, page VIII.

* Wiring for 3-way switch, see page X.

C



7000 Series

Rocker and Lever Handle Switches

ACTUATORS—PANEL REAR MOUNT

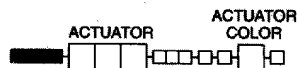

J1 (STD.)

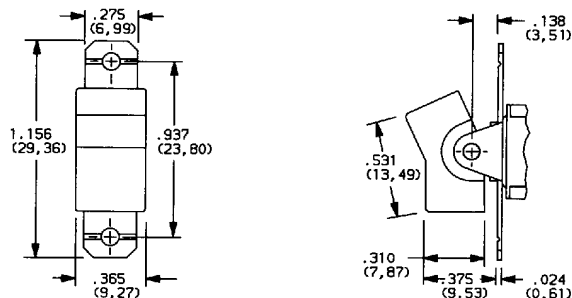
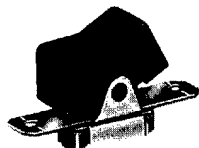

J2

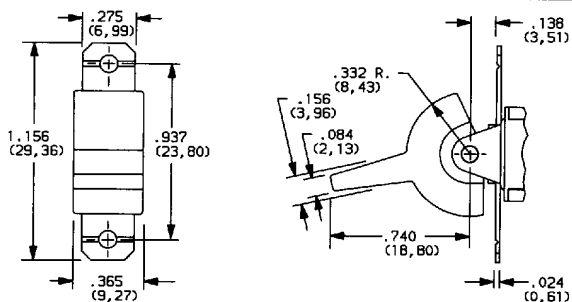
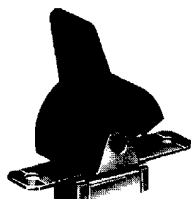

J54

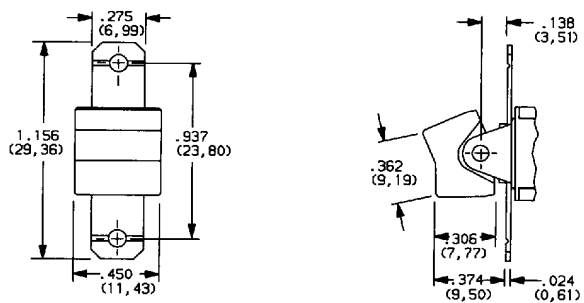

J64

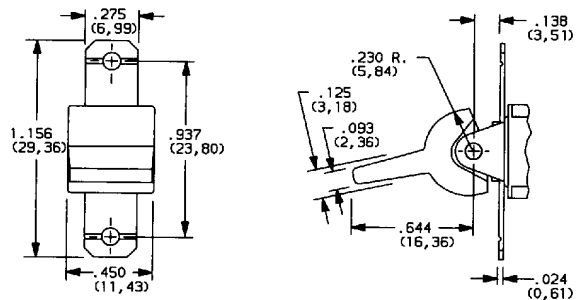
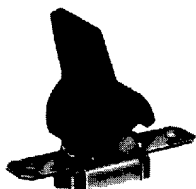

J94

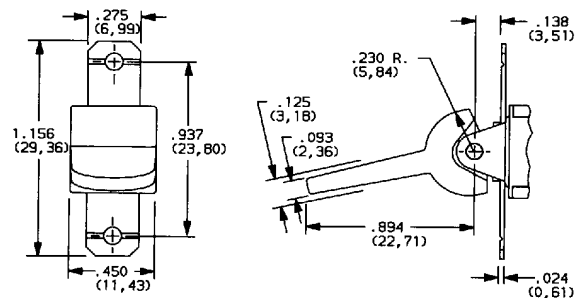

ACTUATOR COLOR

OPTION CODE	ACTUATOR COLORS
1	WHITE
2	BLACK (std.)
3	RED
4	ORANGE
5	YELLOW
6	GREEN
7	BLUE
8	BROWN
9	GRAY

Select actuator color from chart. Place option code in appropriate box of ordering format. Finish: matte. Custom actuator markings and legends available, consult factory. Mounting hardware included, see HOW TO ORDER, page C-48. Hardware is available separately, see catalog section H.

Available with Z, C, Z3 or W-W5 terminations.

PANEL MOUNTING J1 - J2

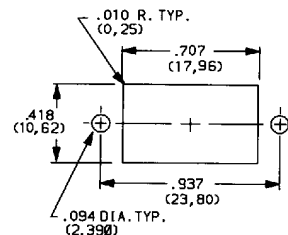

PANEL MOUNTING J54 - J64 - J94

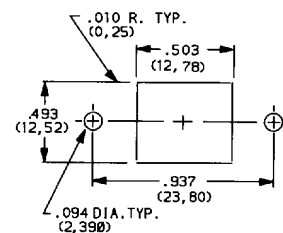

C&K COMPONENTS, INC.

57 Stanley Avenue. Watertown MA 02172-1890

Tel: (617) 926-6400, Fax: (617) 926-6846

C-30

D 94E 1760885 0004133 990



ACTUATORS—PANEL REAR MOUNT

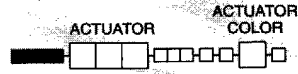

J3

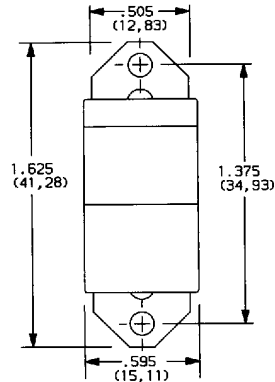
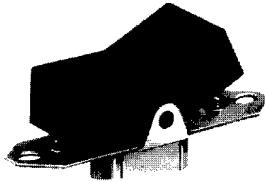

DIMPLES MFG. OPTION

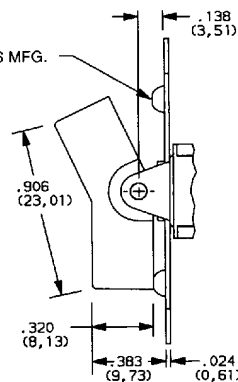

J4

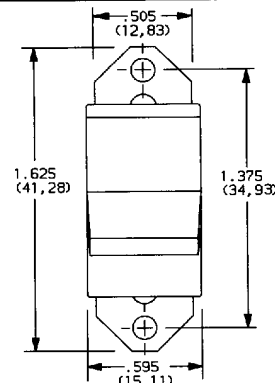
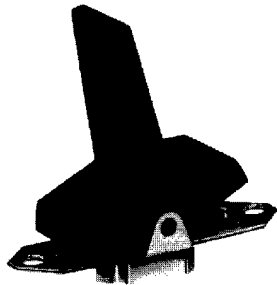

DIMPLES MFG. OPTION

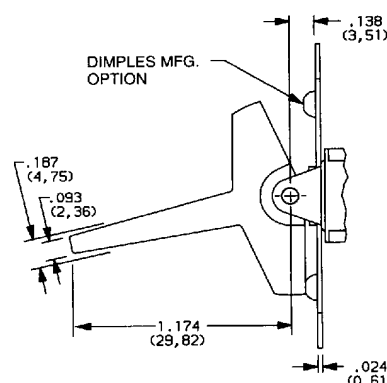

J5

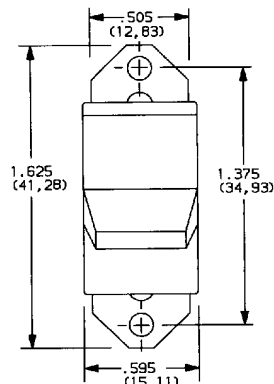
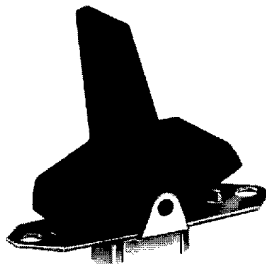

DIMPLES MFG. OPTION

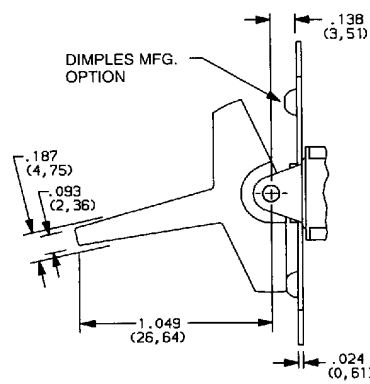

J10

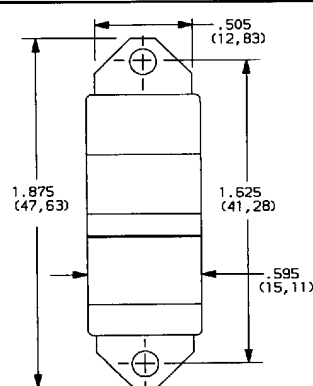
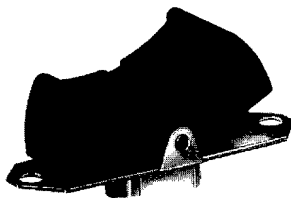

DIMPLES MFG. OPTION

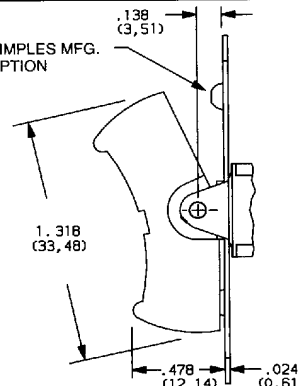

ACTUATOR COLOR

OPTION CODE	ACTUATOR COLORS
1	WHITE
2	BLACK (std.)
3	RED
4	ORANGE
5	YELLOW
6	GREEN
7	BLUE
8	BROWN
9	GRAY

Select actuator color from chart. Place option code in appropriate box of ordering format. Finish: matte. Custom actuator markings and legends available, consult factory. Mounting hardware included, see HOW TO ORDER, page C-48. Hardware is available separately, see catalog section H.

Available with Z, C, Z3 or W-W5 terminations.

PANEL MOUNTING J3 - J4 - J5

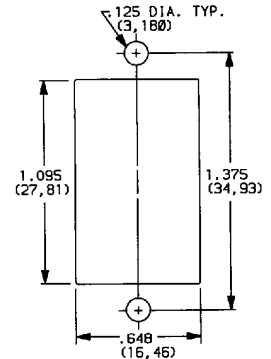

PANEL MOUNTING J10

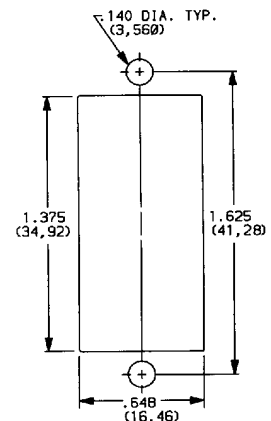

C



7000 Series

Rocker and Lever Handle Switches

ACTUATORS — SNAP-IN FRONT MOUNT

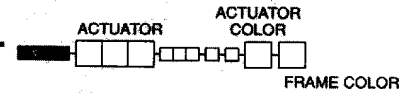

J15

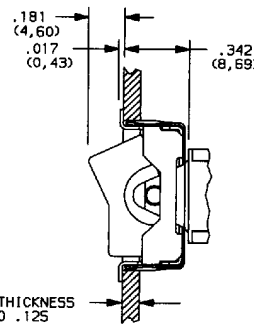
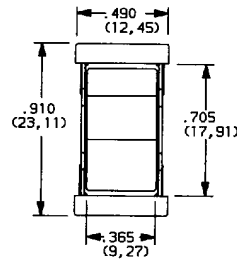
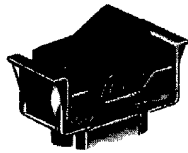

PANEL THICKNESS .047 TO .125 (1,19) (3,18)

No frame color choice required.

J16

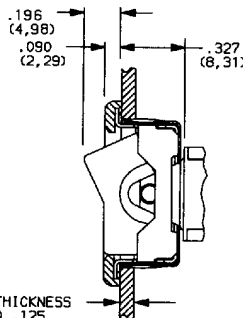
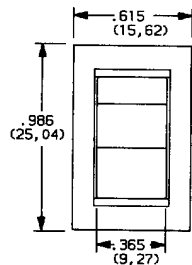
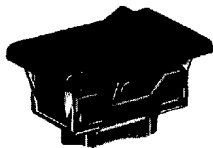

PANEL THICKNESS .047 TO .125 (1,19) (3,18)

J25

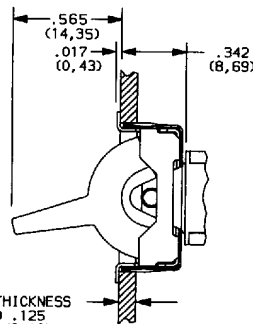
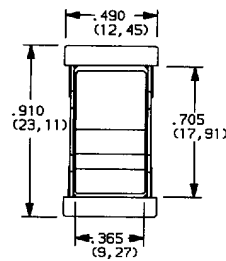
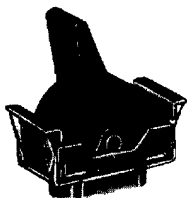

PANEL THICKNESS .047 TO .125 (1,19) (3,18)

No frame color choice required.

J26

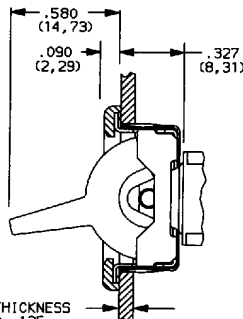
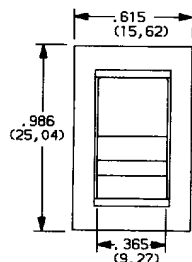
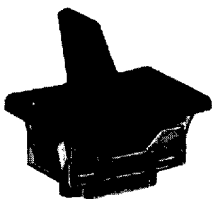

PANEL THICKNESS .047 TO .125 (1,19) (3,18)

ACTUATOR AND FRAME COLORS

OPTION CODE	ACTUATOR AND FRAME COLORS
1	WHITE
2	BLACK (std.)
3	RED
4	ORANGE
5	YELLOW
6	GREEN
7	BLUE
8	BROWN
9	GRAY

Select actuator color and frame color (where applicable) from chart. Place option code(s) in appropriate box(es) of ordering format. Actuator and frame finish: matte. Custom actuator markings and legends available, consult factory. Frames are available separately, see catalog section H.

Available with 71XX, 72XX, U1XX, U2XX models and Z, C, Z3, or W-W5 terminations.

PANEL MOUNTING

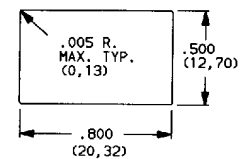

C&K COMPONENTS, INC.

57 Stanley Avenue, Watertown, MA 02172-4802

Tel: (617) 926-6400, Fax: (617) 926-6846

C-32

D 94E ■ 1760885 0004135 763 ■



7000 Series

Rocker and Lever Handle Switches

ACTUATORS — SNAP-IN FRONT MOUNT



J50

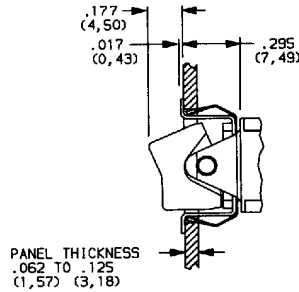
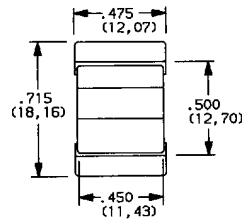

No frame color choice required.

J51

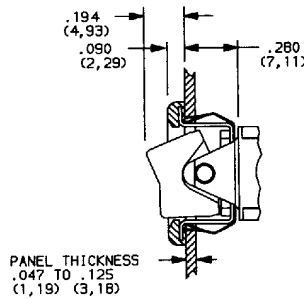
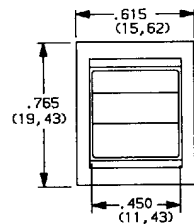

J52

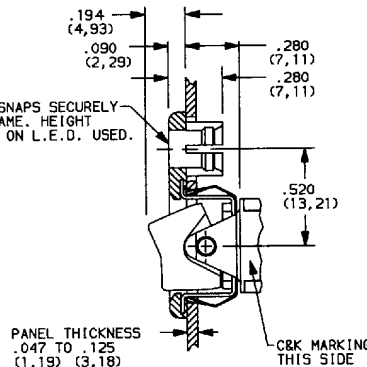
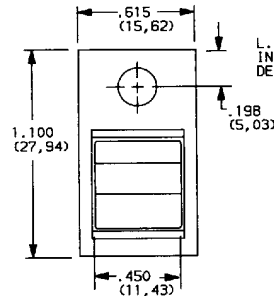

U.S. Patent No. 4,004, 120. LED not included. See page IX for LED information.

J53

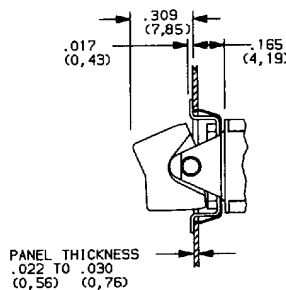
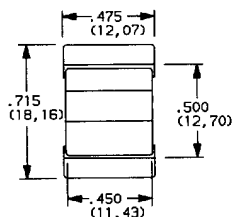

No frame color choice required.

ACTUATOR AND FRAME COLORS

OPTION CODE	ACTUATOR AND FRAME COLORS
1	WHITE
2	BLACK (std.)
3	RED
4	ORANGE
5	YELLOW
6	GREEN
7	BLUE
8	BROWN
9	GRAY

Select actuator color and frame color (where applicable) from chart. Place option code(s) in appropriate box(es) of ordering format. Actuator and frame finish: matte. Custom actuator markings and legends available, consult factory. Frames are available separately, see catalog section H.

Available with 71XX, 72XX, U1XX, U2XX models and Z, C, Z3, or W-W5 terminations.

PANEL MOUNTING — J50, J51, J53

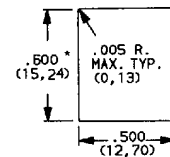

PANEL MOUNTING — J52

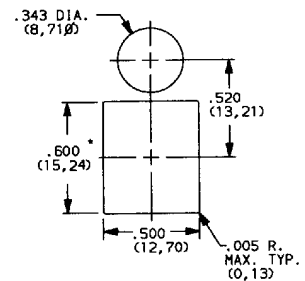

* For J50: Increase this dim. to .620/.625 (15,75/15,88) for .091/.125 (2,31/3,18) thk. panels.
For J51, J52: Increase this dim. to .620/.625 (15,75/15,88) for .060/.125 (1,52/3,18) thk. panels.

C&K COMPONENTS, INC.

57 Stanley Avenue, Watertown, MA 02172-4802

Tel: (617) 926-6400, Fax: (617) 926-6846

D 94E ■ 1760885 0004136 6TT ■

C-33



7000 Series

Rocker and Lever Handle Switches

ACTUATORS — SNAP-IN FRONT MOUNT

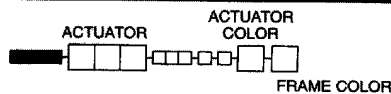

J60

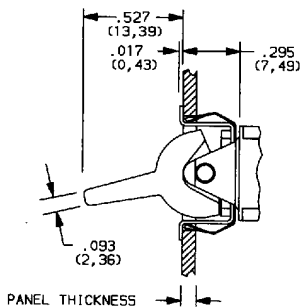
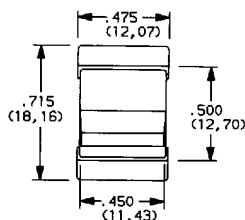
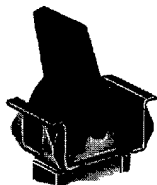

PANEL THICKNESS .062 TO .125 (1,57) (3,18)

No frame color choice required.

J61

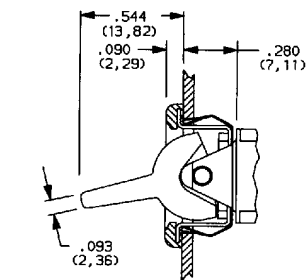
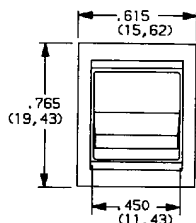

PANEL THICKNESS .047 TO .125 (1,19) (3,18)

J62

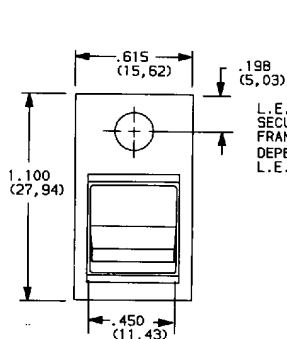
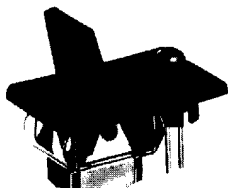

L.E.D. SNAPS SECURELY INTO FRAME. HEIGHT DEPENDS ON L.E.D. USED.

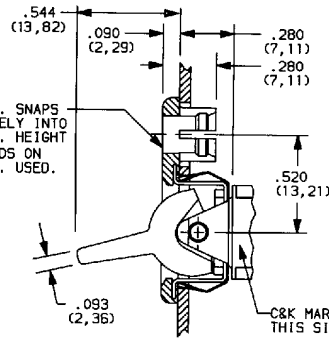

PANEL THICKNESS .047 TO .125 (1,19) (3,18)

U.S. Pat. No. 4,004, 120. LED not included. See page IX for LED information.

J63

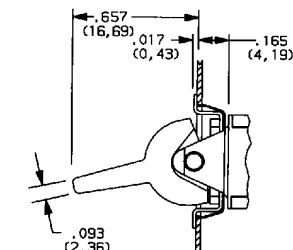
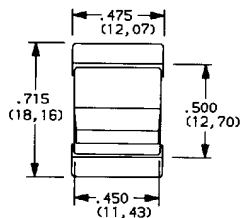

PANEL THICKNESS .022 TO .030 (0,56) (0,76)

No frame color choice required.

ACTUATOR AND FRAME COLORS

OPTION CODE	ACTUATOR AND FRAME COLORS
1	WHITE
2	BLACK (std.)
3	RED
4	ORANGE
5	YELLOW
6	GREEN
7	BLUE
8	BROWN
9	GRAY

Select actuator color and frame color (where applicable) from chart. Place option code(s) in appropriate box(es) of ordering format. Actuator and frame finish: matte. Custom actuator markings and legends available, consult factory. Frames are available separately, see catalog section H.

Available with 71XX, 72XX, U1XX, U2XX models and Z, C, Z3, or W-W5 terminations.

PANEL MOUNTING — J60, J61, J63

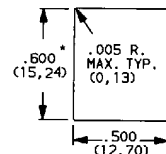

PANEL MOUNTING — J62

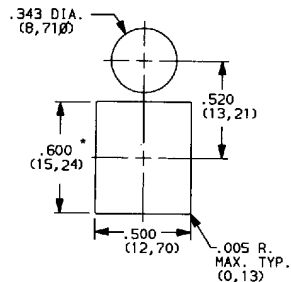

* For J60: Increase this dim. to .620/.625 (15,75/15,88) for .091/.125 (2,31/3,18) thk. panels.
For J61, J62: Increase this dim. to .620/.625 (15,75/15,88) for .060/.125 (1,52/3,18) thk. panels.

C&K COMPONENTS, INC.

57 Stanley Avenue, Watertown, MA 02172-4802

Tel: (617) 926-6400, Fax: (617) 926-6846

C-34

D 94E ■ 1760885 0004137 536 ■



7000 Series

Rocker and Lever Handle Switches

ACTUATORS — SNAP-IN FRONT MOUNT

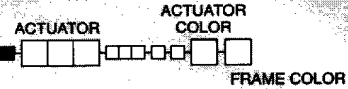

J90

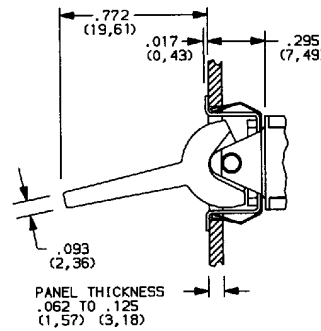
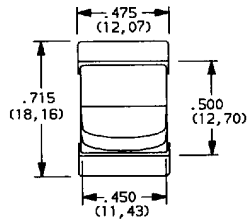
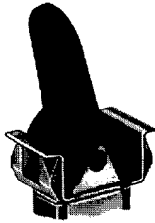

No frame color choice required.

J91

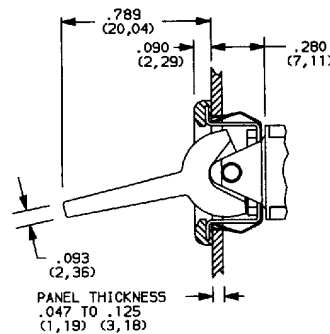
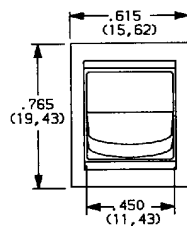

J92

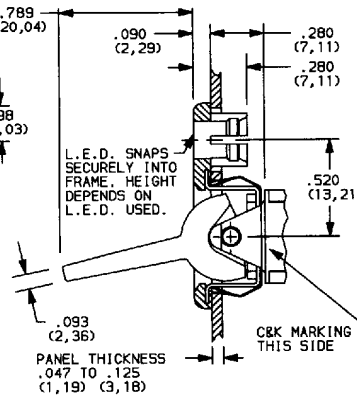
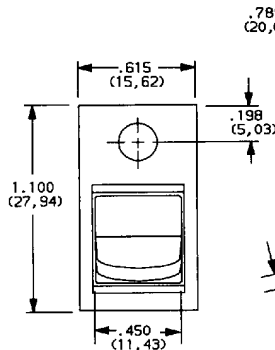
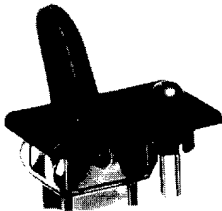

U.S. Pat. No 4, 004, 120. LED not included. See page IX for LED information.

J93

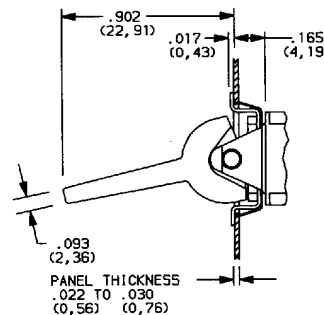
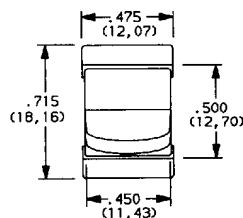

No frame color choice required.

ACTUATOR AND FRAME COLORS

OPTION CODE	ACTUATOR AND FRAME COLORS
1	WHITE
2	BLACK (std.)
3	RED
4	ORANGE
5	YELLOW
6	GREEN
7	BLUE
8	BROWN
9	GRAY

Select actuator color and frame color (where applicable) from chart. Place option code(s) in appropriate box(es) of ordering format. Actuator and frame finish: matte. Custom actuator markings and legends available, consult factory. Frames are available separately, see catalog section H.

Available with 71XX, 72XX, U1XX, U2XX models and Z, C, Z3, or W-W5 terminations.

PANEL MOUNTING — J90, J91, J93

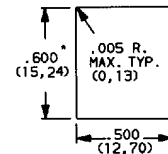

PANEL MOUNTING — J92

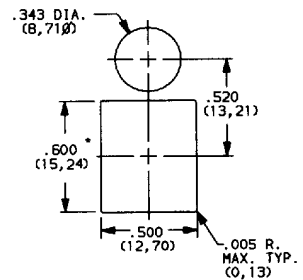

* For J90: Increase this dim. to .620/.625 (15.75/15.88) for .091/.125 (2.31/3.18) thk. panels. For J91, J92: Increase this dim. to .620/.625 (15.75/15.88) for .060/.125 (1.52/3.18) thk. panels.

C&K COMPONENTS, INC.

57 Stanlev Avenue. Watertown. MA 02172-4802

Tel: (617) 926-6400, Fax: (617) 926-6846

D 94E 1760885 0004138 472

C-35

C



7000 Series

Rocker and Lever Handle Switches

ACTUATORS—REAR MOUNT

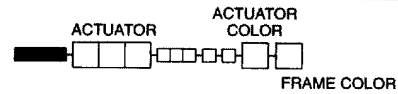

J11

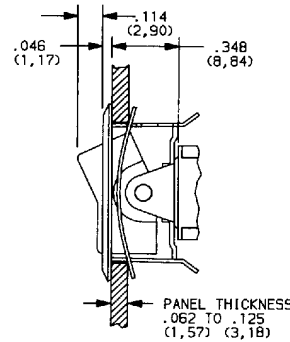
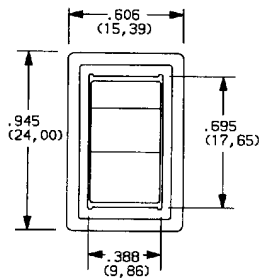

ACTUATOR COLOR

OPTION CODE	ACTUATOR COLOR
1	WHITE
2	BLACK (std.)
3	RED
4	ORANGE
5	YELLOW
6	GREEN
7	BLUE
8	BROWN
9	GRAY

FRAME COLOR

OPTION CODE	FRAME COLOR
1	WHITE
2	BLACK (std.)
C	BRIGHT CHROME
S	SATIN CHROME

Select actuator and frame colors from respective charts. Place option codes in appropriate boxes of ordering format. Actuator finish: matte. Frame finish: gloss. Custom actuator markings and legends available, consult factory. Frames are available separately, see catalog section H.

Available with Z, C, Z3, or W-W5 terminations.

PANEL MOUNTING—J11, J21

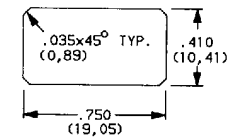

PANEL MOUNTING—J19

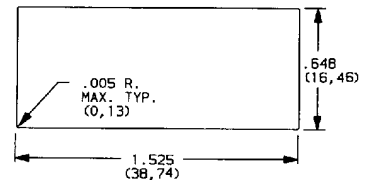

PANEL MOUNTING—J37

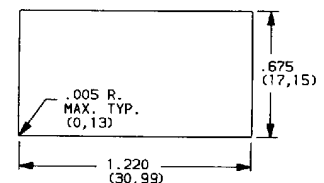

J21

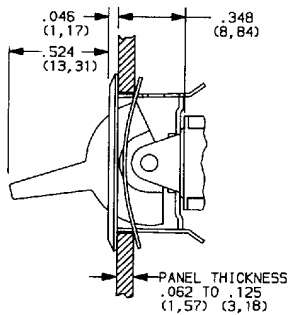
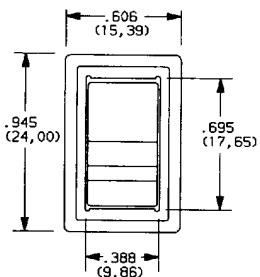
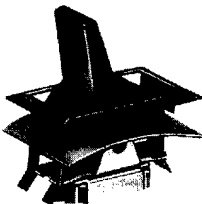

J19

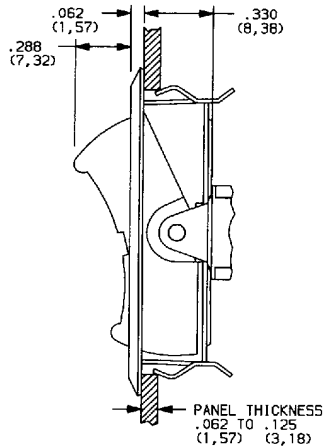
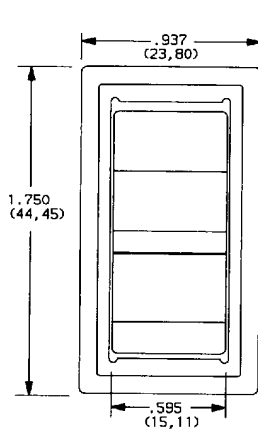
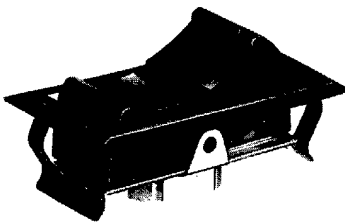

J37

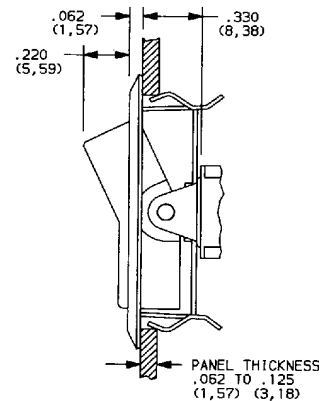
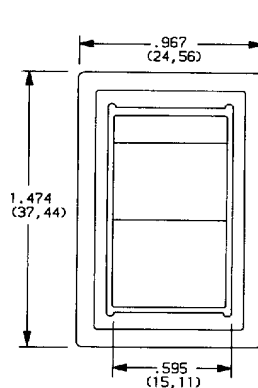
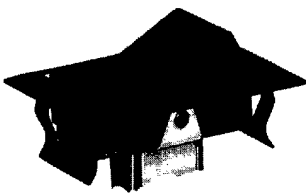

C&K COMPONENTS, INC.

57 Stanley Avenue, Watertown, MA 02172-4802

Tel: (617) 926-6400, Fax: (617) 926-6846

C-36

94E 1760885 0004139 309



ACTUATORS—REAR MOUNT

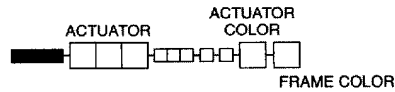

J47

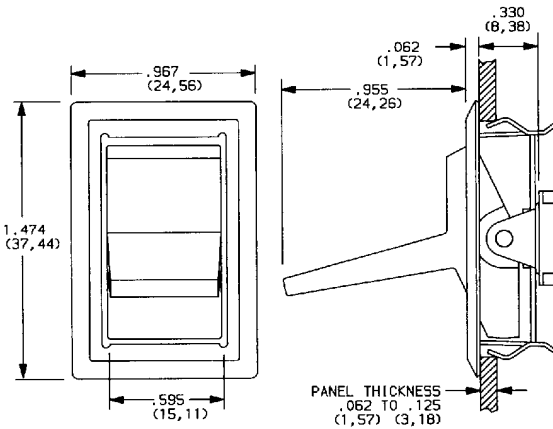
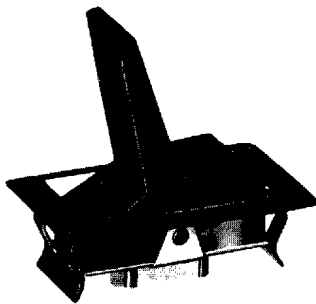

ACTUATOR COLOR

OPTION CODE	ACTUATOR COLOR
1	WHITE
2	BLACK (std.)
3	RED
4	ORANGE
5	YELLOW
6	GREEN
7	BLUE
8	BROWN
9	GRAY

Select actuator and frame colors from respective charts. Place option codes in appropriate boxes of ordering format. Actuator finish: matte, frame finish: gloss. Custom actuator markings and legends available, consult factory. Frames are available separately, see catalog section H.

FRAME COLOR

OPTION CODE	FRAME COLOR
1	WHITE
2	BLACK (std.)
C	BRIGHT CHROME
S	SATIN CHROME

J47, J57 actuators available with Z, C, Z3, or W-W5 terminations.

PANEL MOUNTING J47 - J57

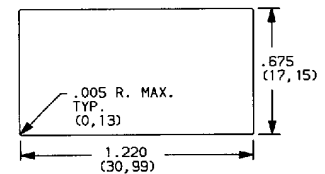

J57

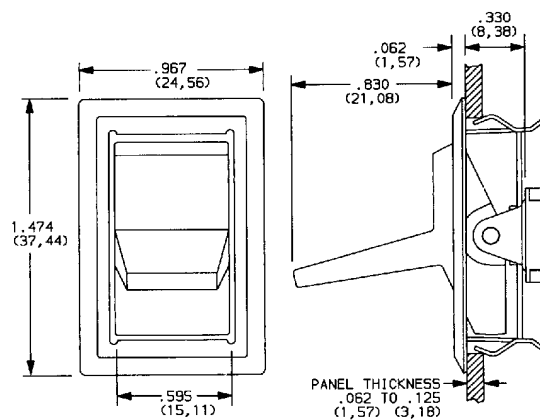
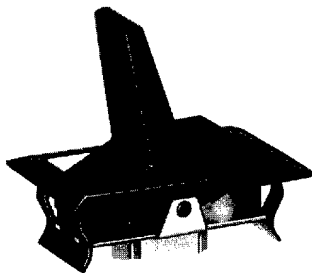

ACTUATORS—P.C. MOUNT

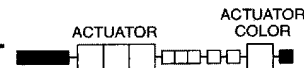

J1

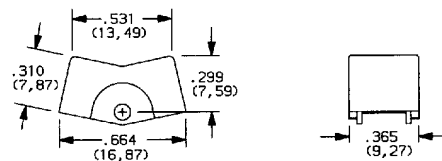

ACTUATOR COLOR

OPTION CODE	ACTUATOR COLOR
1	WHITE
2	BLACK (std.)
3	RED
4	ORANGE
5	YELLOW
6	GREEN
7	BLUE
8	BROWN
9	GRAY

Select actuator color from chart. Place option code in appropriate box of ordering format. Finish: matte. Custom actuator markings and legends available, consult factory. Actuators available separately, see catalog section H.

J2

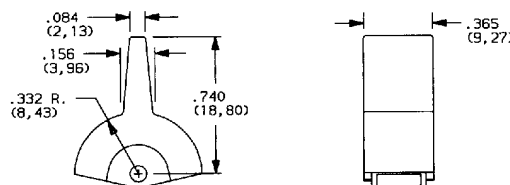

J1, J2 actuators available with A, A3, AW-AW5, AV2-AV5, V2-V91 terminations. Some permissible actuator/termination combinations may lack clearance between act. and P.C. board, and care must be exercised to accommodate this condition.

C



7000 Series

Rocker and Lever Handle Switches

ACTUATORS—PC MOUNT

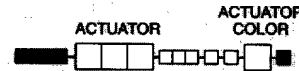

J3

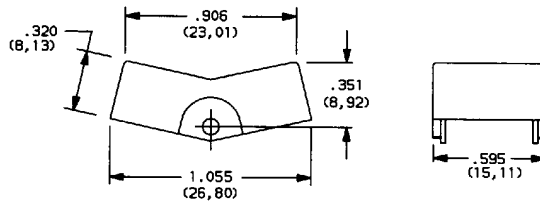
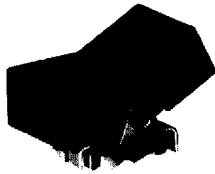

J4

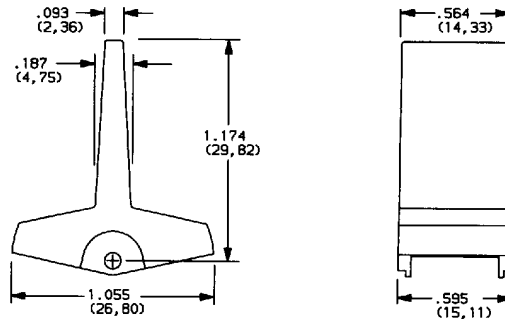
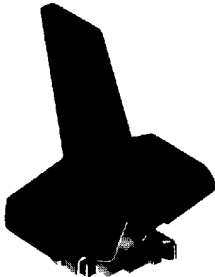

ACTUATOR COLOR

OPTION CODE	ACTUATOR COLOR
1	WHITE
2	BLACK (std.)
3	RED
4	ORANGE
5	YELLOW
6	GREEN
7	BLUE
8	BROWN
9	GRAY

Select actuator color from chart. Place option code in appropriate box of ordering format. Finish: matte. Custom actuator markings and legends available, consult factory. Actuators are available separately, see catalog section H.

J3, J4, & J5 actuators available with AV2-AV5, V2-V91 terminations. Some permissible actuator/termination combinations may lack clearance between actuator and PC board, and care must be exercised to accommodate this condition.

J50, J60, & J90 actuators available with A (DP, 3P models only), A3, AW-AW5, AV2-AV5, & V2-V91 terminations.

J5

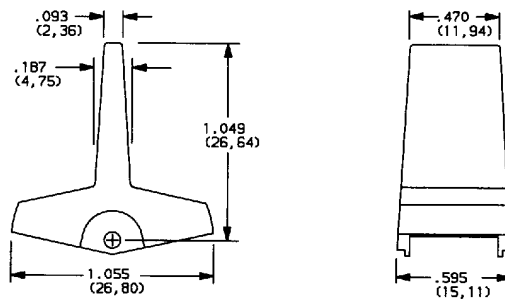
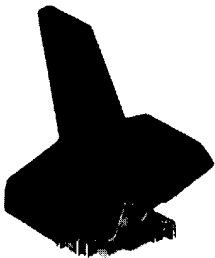

J50

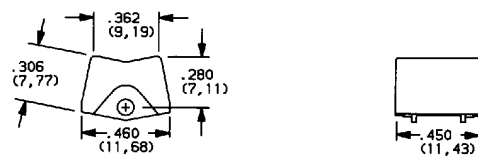

J60

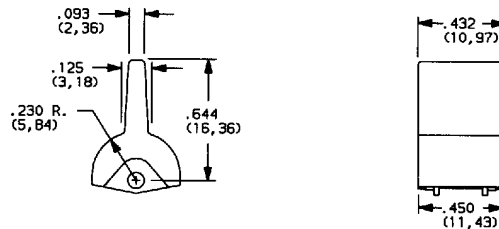

J90

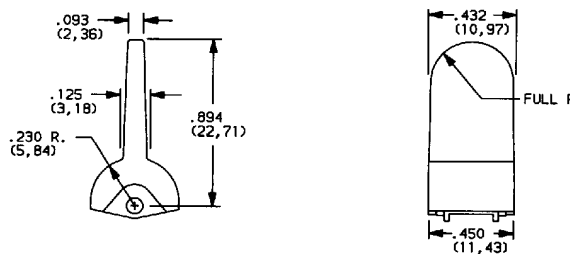

C&K COMPONENTS, INC.

57 Stanley Avenue. Watertown, MA 02172-4802

Tel: (617) 926-6400, Fax: (617) 926-6846

C-38

D 94E ■ 1760885 0004141 T67 ■



TERMINATIONS

Z (STD.)

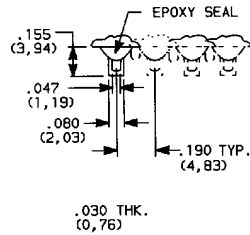

SPDT thru 4PDT

Q contact material std. Not available with K, L, or M contact materials. Available actuators, see pages C-30 thru C-37.

C

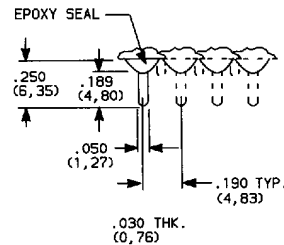

SPDT thru 4PDT

Q contact material std. Available actuators, see pages C-30 thru C-37.

PC MOUNTING

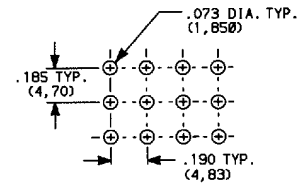

Z3 QUICK CONNECT

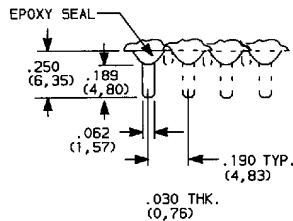

SPDT thru 4PDT

Q contact material std. Available actuators, see pages C-30 thru C-37. Not available with K, L, or M contact materials. Mating quick connector available; order part no. 530100000.

W-W1-W3-W4-W5 WIRE WRAP

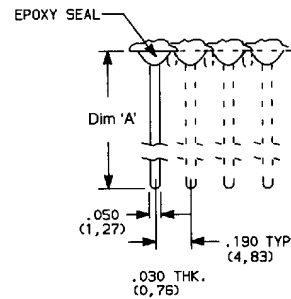

SPDT thru 4PDT

B contact material std. Available actuators, see pages C-30 thru C-37.

Option	Dim 'A'
W	.750 (19,05)
W1	.964 (24,49)
W3	.425 (10,80)
W4	1.062 (26,97)
W5	1.305 (33,15)

A

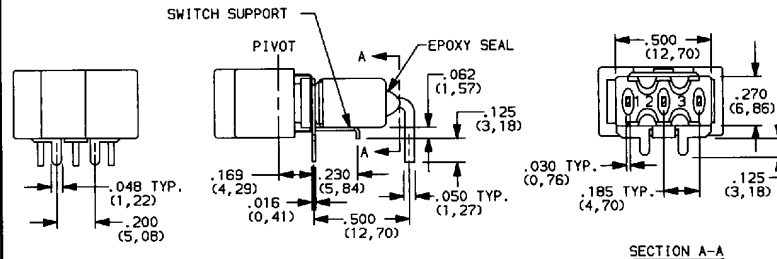

PC MOUNTING

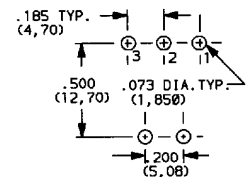

TERM. NOS. FOR REFERENCE ONLY

Part No. Shown: 7101J1ABE2



A

SPDT

Term. bend radii and lead-in mfg. option. Actuator shown in pos. 1. B contact material std. Not available with I seal option Note: PC pattern must clear switch support leg. Available actuators, see pages C-37 and C-38.

A3 SNAP-IN

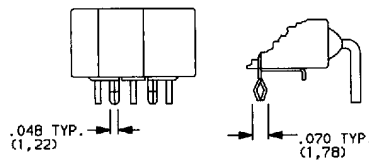

SNAP-IN DESIGN RETAINS SWITCH.

AW-AW1-AW3-AW4-AW5 EXTENDED

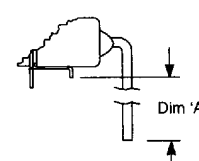

Option	Dim 'A'
AW	.44 (11,2)
AW1	.66 (16,8)
AW3	.14 (3,6)
AW4	.77 (19,6)
AW5	1.02 (25,9)

C



7000 Series

Rocker and Lever Handle Switches

TERMINATIONS

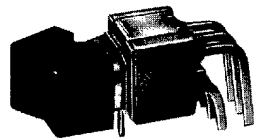
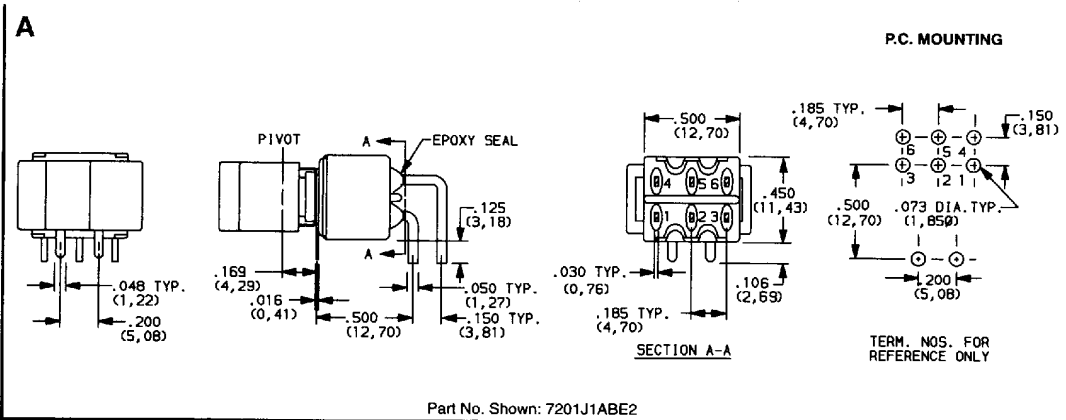

A

DPDT

Term. bend radii and lead-in mfg. option. Actuator shown in pos. 1. B contact material std. Not available with I seal option. Available actuators, see pages C-37 and C-38.

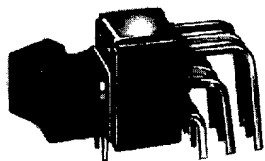
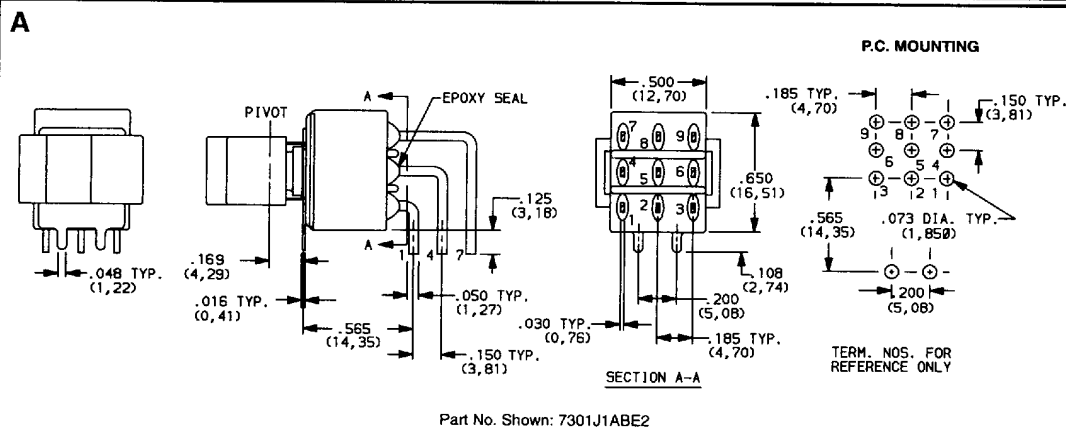
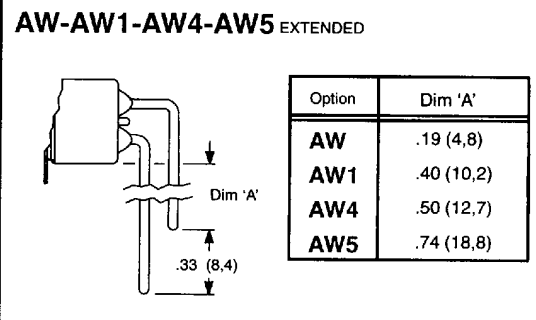
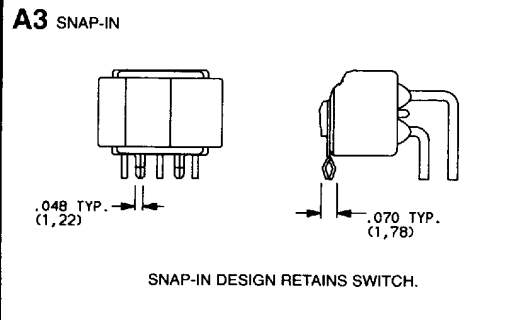

A

3PDT

Term. bend radii and lead-in mfg. option. Actuator shown in pos. 1. B contact material std. Not available with I seal option. Available actuators, see pages C-37 and C-38.

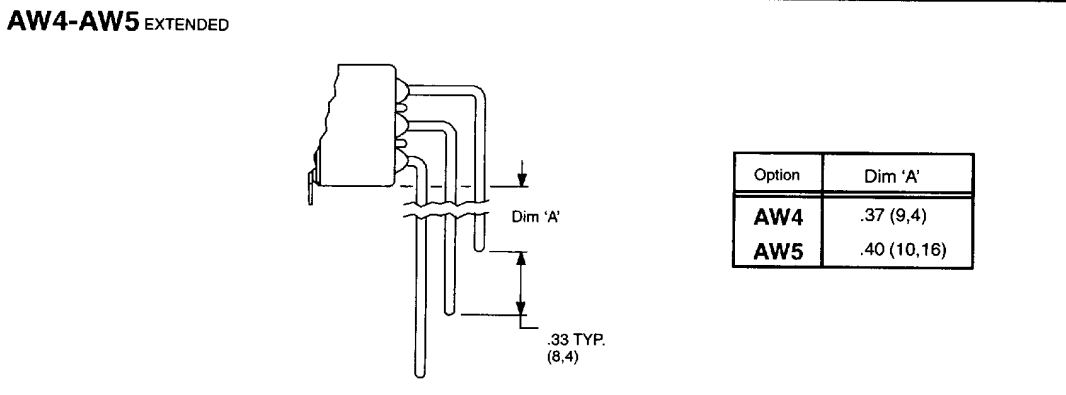

C&K COMPONENTS, INC.

57 Stanlev Avenue. Watertown, MA 02172-4802

Tel: (617) 926-6400, Fax: (617) 926-6846

C-40

D 94E 1760885 0004143 83T



TERMINATIONS

AV2

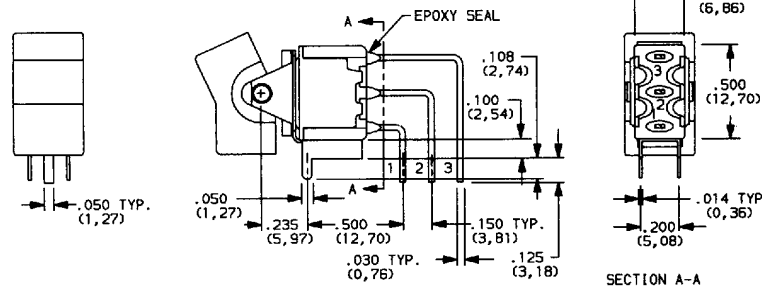

P.C. MOUNTING

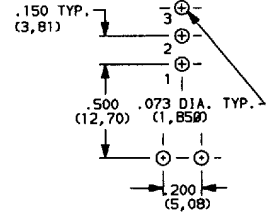

SECTION A-A

TERM. NOS. FOR REFERENCE ONLY

Part No. Shown: 7101J1AV2BE2

AV3 SNAP-IN

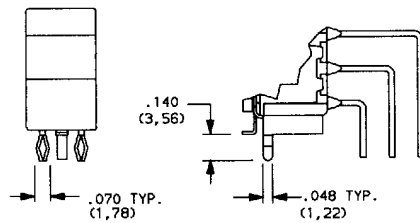

SNAP-IN DESIGN RETAINS SWITCH.

AV5 EXTENDED

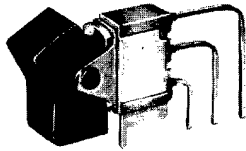
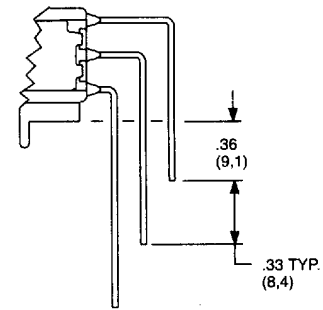

AV2

SPDT

Term. bend radii and lead-in mfg. option.
 Actuator shown in pos. 1.
 B contact material std.
 Not available with I seal option.
 Available actuators, see pages C-37 and C-38.

AV2

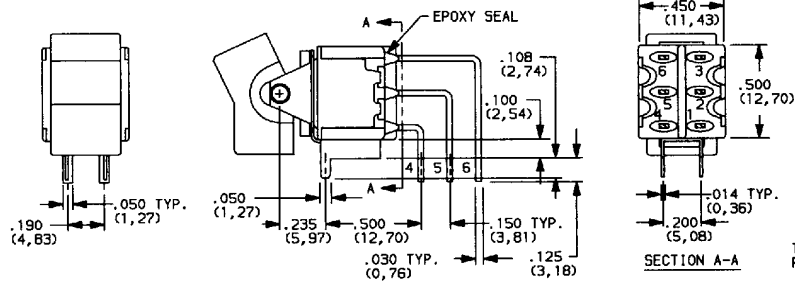

P.C. MOUNTING

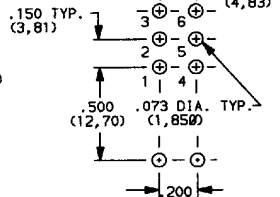

SECTION A-A

TERM. NOS. FOR REFERENCE ONLY

Part No. Shown: 7201J1AV2BE2

AV3 SNAP-IN

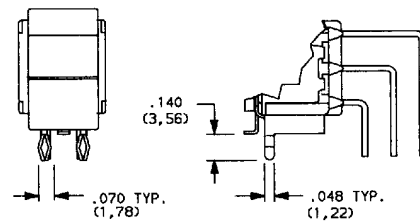

SNAP-IN DESIGN RETAINS SWITCH.

AV5 EXTENDED

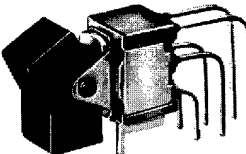
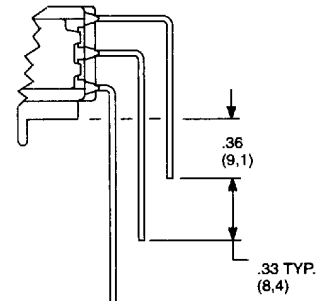

AV2

DPDT

Term. bend radii and lead-in mfg. option.
 Actuator shown in pos. 1.
 B contact material std.
 Not available with I seal option.
 Available actuators, see pages C-37 and C-38.

C

TERMINATIONS

AV2

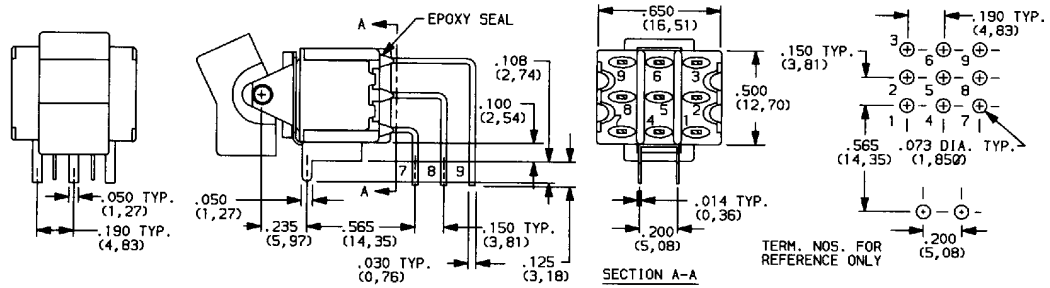

Part No. Shown: 7301J1AV2BE2

AV3 SNAP-IN

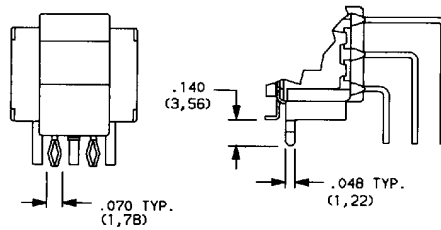

SNAP-IN DESIGN RETAINS SWITCH.

AV5 EXTENDED

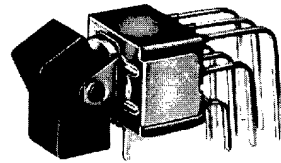
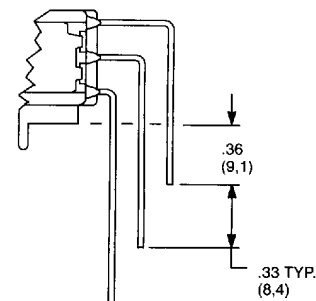

AV2

3PDT

Term. bend radii and lead-in mfg. option.
Actuator shown in pos. 1.
B contact material std.
Not available with I seal option.
Available actuators, see pages C-37
and C-38.

AV2

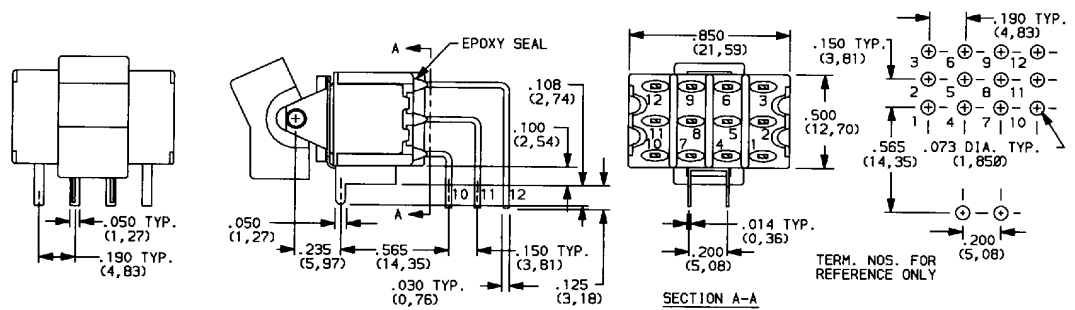

Part No. Shown: 7401J1AV2BE2

AV3 SNAP-IN

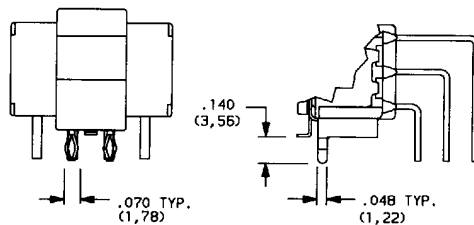

SNAP-IN DESIGN RETAINS SWITCH.

AV5 EXTENDED

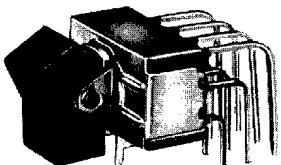
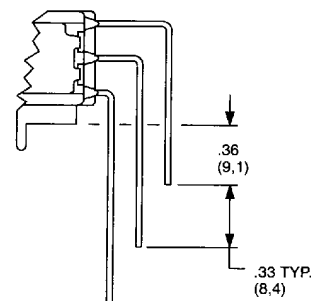

AV2

4PDT

Term. bend radii and lead-in mfg. option.
Actuator shown in pos. 1.
B contact material std.
Not available with I seal option.
Available actuators, see pages C-37
and C-38.



TERMINATIONS

V5

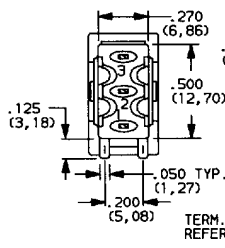
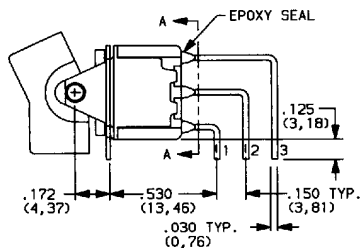
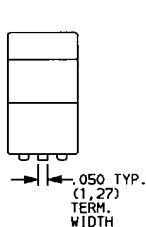

P.C. MOUNTING

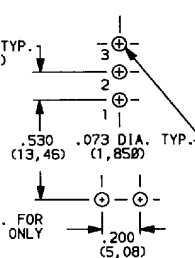

Part No. Shown: 7101J1V5BE2

V51 SNAP-IN

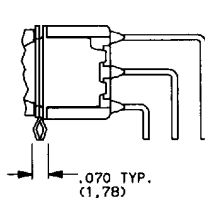
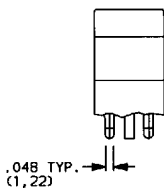

SNAP-IN DESIGN RETAINS SWITCH.

V54-V55 EXTENDED

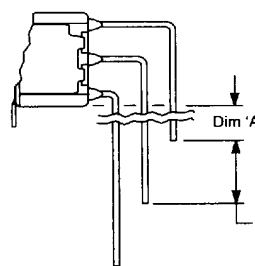

Option	Dim 'A'
V54	.24 (6, 1)
V55	.48 (12, 2)

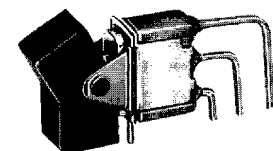

V5

SPDT

Term. bend radii and lead-in mfg. option. Actuator shown in pos. 1. B contact material std. Not available with I seal option. Available actuators, see pages C-37 and C-38.

V5

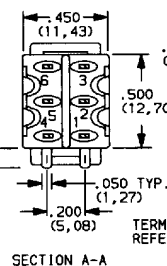
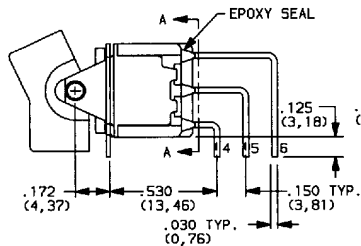
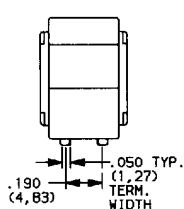

P.C. MOUNTING

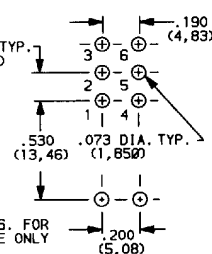

Part No. Shown: 7201J1V5BE2

V51 SNAP-IN

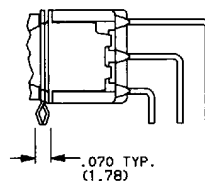
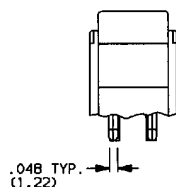

SNAP-IN DESIGN RETAINS SWITCH.

V54-V55 EXTENDED

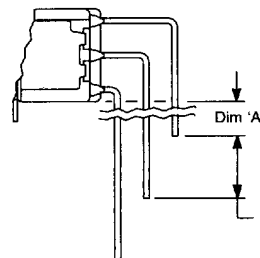

Option	Dim 'A'
V54	.24 (6, 1)
V55	.48 (12, 2)

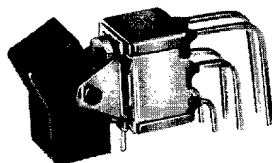

V5

DPDT

Term. bend radii and lead-in mfg. option. Actuator shown in pos. 1. B contact material std. Not available with I seal option. Available actuators, see pages C-37 and C-38.

TERMINATIONS

V3-V4-V9

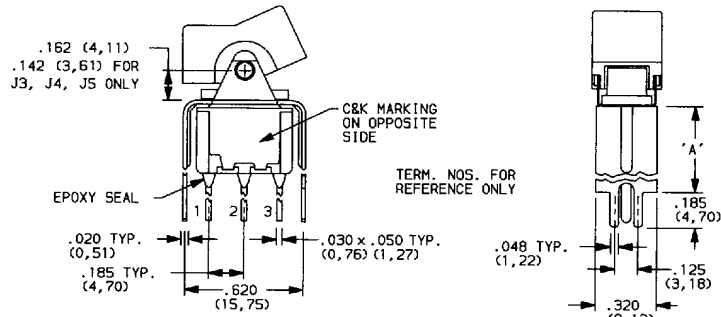

Part No. Shown: 7101J1V_BE2

V31-V41-V91 SNAP-IN

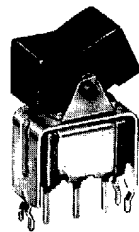

V31

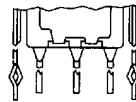

SNAP-IN DESIGN RETAINS SWITCH.

P.C. MOUNTING

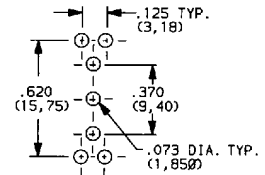

Option	Dim 'A'
V3, V31	.460 (11,68)
V4, V41	.630 (16,00)
V9, V91	1.150 (29,21)

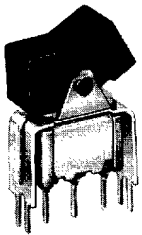

V3

SPDT

Actuator shown in pos.1.
B contact material std.
Not available with I seal option.
Available actuators, see pages C-37
and C-38.

V3-V4-V9

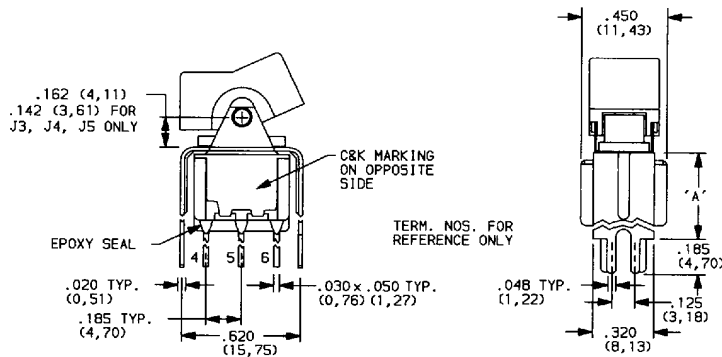

Part No. Shown: 7201J1V_BE2

V31-V41-V91 SNAP-IN

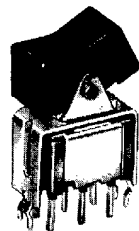

V31

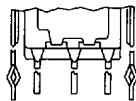

SNAP-IN DESIGN RETAINS SWITCH.

P.C. MOUNTING

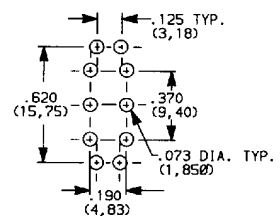

Option	Dim 'A'
V3, V31	.460 (11,68)
V4, V41	.630 (16,00)
V9, V91	1.150 (29,21)

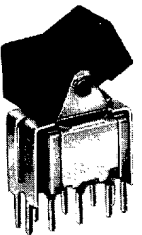

V3

DPDT

Actuator shown in pos.1.
B contact material std.
Not available with I seal option.
Available actuators, see pages C-37
and C-38.

TERMINATIONS

V4-V9

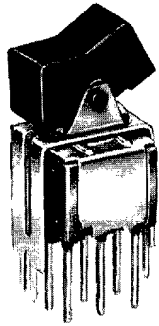
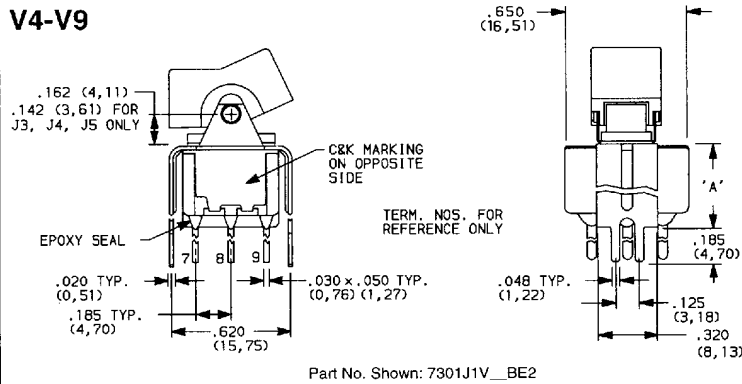

V4

3PDT

Actuator shown in pos. 1.
B contact material std.
Not available with I seal option.
Available actuators, see pages C-37
and C-38.

V41-V91 SNAP-IN

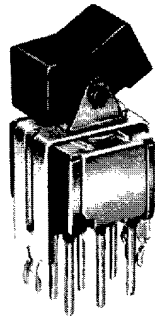

V41

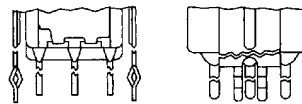

SNAP-IN DESIGN RETAINS SWITCH.

P.C. MOUNTING

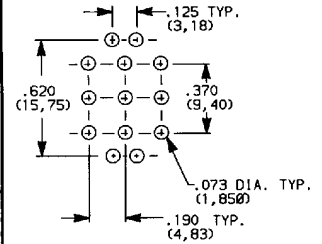

Option	Dim 'A'
V4, V41	.630 (16,00)
V9, V91	1.150 (29,21)

V4-V9

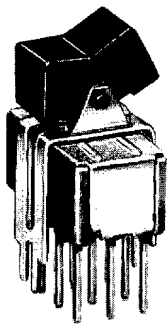
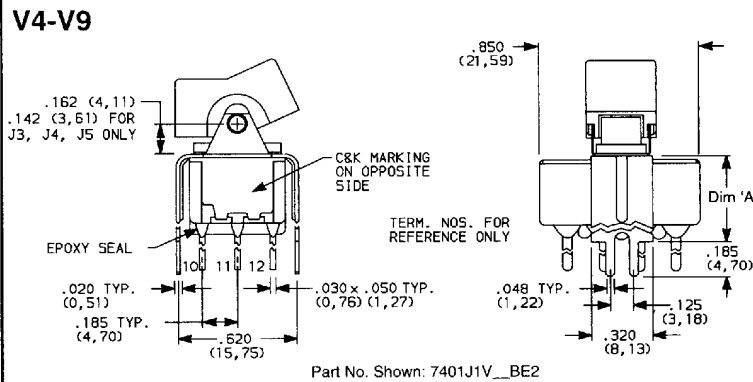

V4

4PDT

Actuator shown in pos. 1.
B contact material std.
Not available with I seal option.
Available actuators, see pages C-37
and C-38.

V41-V91 SNAP-IN

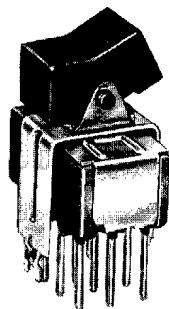

V41

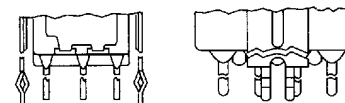

SNAP-IN DESIGN RETAINS SWITCH.

P.C. MOUNTING

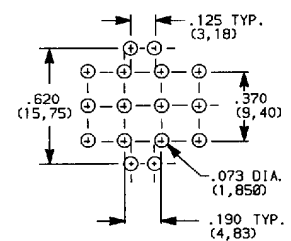

Option	Dim 'A'
V4, V41	.630 (16,00)
V9, V91	1.150 (29,21)

C

TERMINATIONS

V2-V6-V7-V8

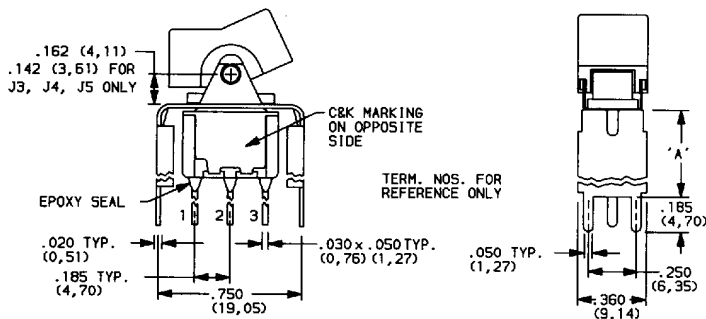

Part No. Shown: 7101J1V__BE2

V21-V61-V71-V81 SNAP-IN

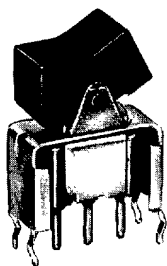

V61

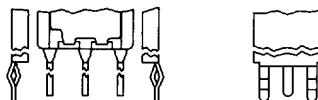

SNAP-IN DESIGN RETAINS SWITCH.

P.C. MOUNTING

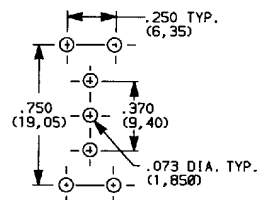

Option	Dim 'A'
V2, V21	.555 (14,10)
V6, V61	.460 (11,68)
V7, V71	.630 (16,00)
V8, V81	.953 (24,21)

C

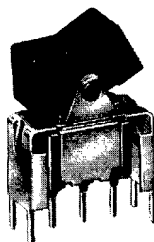

V6

SPDT

Actuator shown in pos.1.
B contact material std.
Not available with I seal option.
Available actuators, see pages C-37
and C-38.

V2-V6-V7-V8

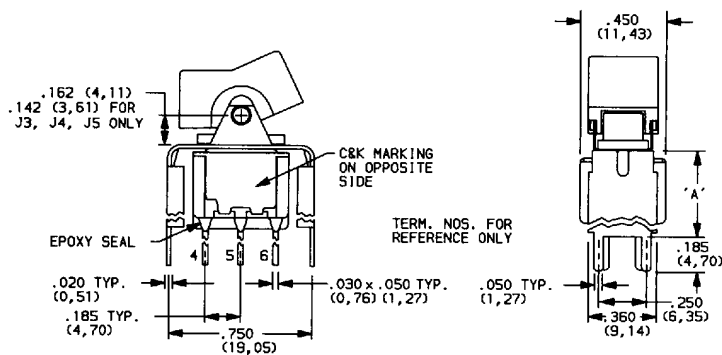

Part No. Shown: 7201J1V__BE2

V21-V61-V71-V81 SNAP-IN

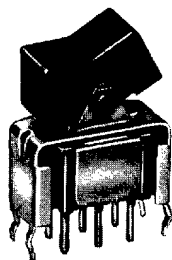

V61

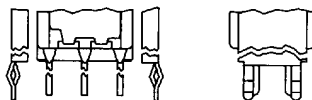

SNAP-IN DESIGN RETAINS SWITCH.

P.C. MOUNTING

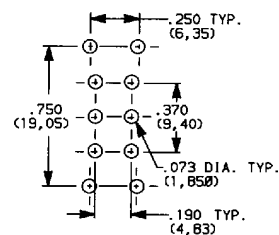

Option	Dim 'A'
V2, V21	.555 (14,10)
V6, V61	.460 (11,68)
V7, V71	.630 (16,00)
V8, V81	.953 (24,21)

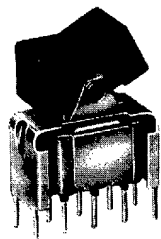

V6

DPDT

Actuator shown in pos.1.
B contact material std.
Not available with I seal option.
Available actuators, see pages C-37
and C-38.



TERMINATIONS

V2-V7-V8

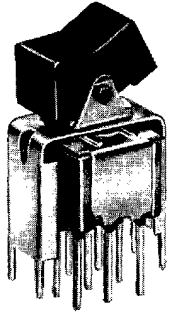

V7

3PDT

Actuator shown in pos.1. B contact material std. Not available with I seal option. Available actuators, see pages C-37 and C-38.

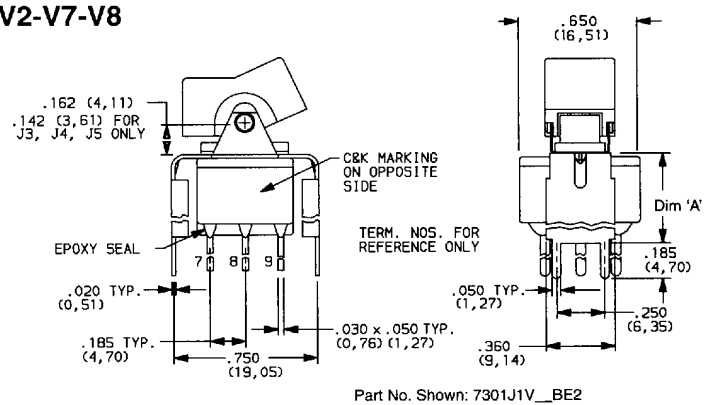

V21-V71-V81 SNAP-IN

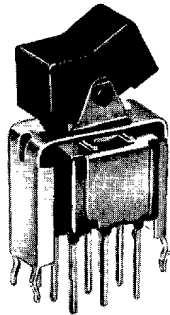

V71

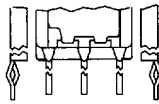

SNAP-IN DESIGN RETAINS SWITCH.

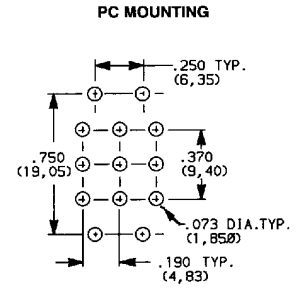

Option	Dim 'A'
V2, V21	.555 (14,10)
V7, V71	.630 (16,00)
V8, V81	.953 (24,21)

V2-V7-V8

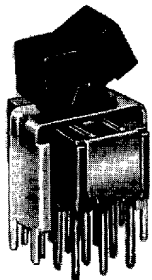

V7

4PDT

Actuator shown in pos.1. B contact material std. Not available with I seal option. Available actuators, see pages C-37 and C-38.

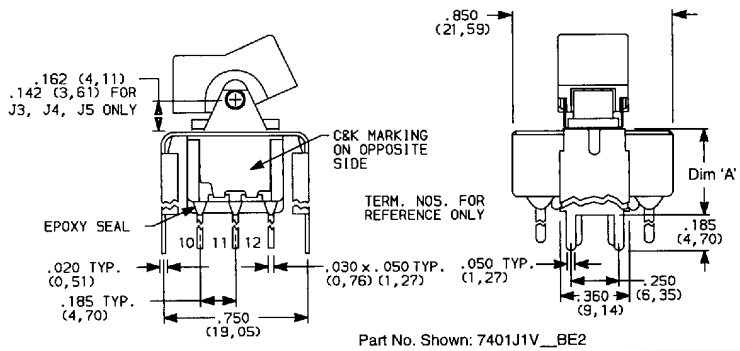

V21-V71-V81 SNAP-IN

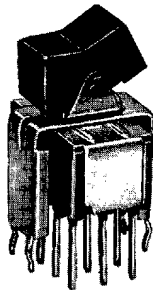

V71

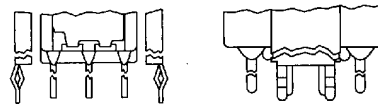

SNAP-IN DESIGN RETAINS SWITCH.

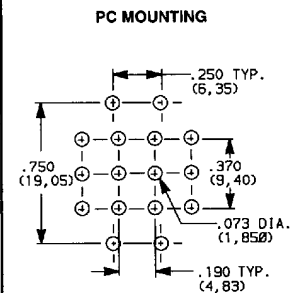

Option	Dim 'A'
V2, V21	.555 (14,10)
V7, V71	.630 (16,00)
V8, V81	.953 (24,21)





CONTACT MATERIAL

OPTION CODE	CONTACT MATERIAL	TERMINAL PLATING	RATINGS	
B	GOLD ¹	GOLD ¹	LOW LEVEL / DRY CIRCUIT	0.4 VA MAX. @ 20 V AC OR DC MAX.
K		TIN-LEAD ⁶		
Q	SILVER ^{4,5}	SILVER ⁵	POWER	5 AMPS @ 120 V AC OR 28 V DC; 2 AMPS @ 250 V AC.
M		TIN-LEAD ⁶		
G	GOLD OVER SILVER ^{2,3}	GOLD ³	LOW LEVEL / DRY CIRCUIT OR POWER	0.4 VA MAX. @ 20 V AC OR DC MAX. OR 5 AMPS @ 120 V AC OR 28 V DC; 2 AMPS @ 250 V AC.
L		TIN-LEAD ⁶		

CONTACT MATERIAL/APPLICATION RECOMMENDATIONS—SEE CHART, PAGE X.

¹ CONTACTS & TERMINALS: Copper alloy, with gold plate over nickel plate.

² END CONTACTS: Coin silver, with gold plate over nickel plate.

³ CENTER CONTACTS & ALL TERMINALS: Copper alloy, with gold plate over nickel plate.

⁴ END CONTACTS: Coin silver, silver plated.

⁵ CENTER CONTACT & ALL TERMINALS: Copper alloy, silver plated.

⁶ TERMINALS: Copper alloy, with tin-lead alloy over nickel plate.

U11-U415 model numbers with all options when ordered with G, L, M or Q contact material. See pages B-32 and VIII.

B contact material standard with all terminations except Z, C, Z3.

Q contact material standard with Z, C, Z3 terminations.

K, L, M contact materials not available with Z, Z3 terminations.

SEAL

E (STD.)

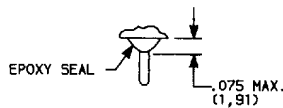

I

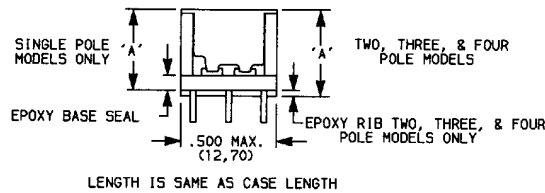

Poles	Dim 'A'
SP	.410 (10,41)
DP	.440 (11,18)
3P	.505 (12,83)
4P	.505 (12,83)

Available with Z, C, Z3, W-W5 terminations only.

HOW TO ORDER

All available 7000 SERIES ROCKER AND LEVER HANDLE SWITCH options are listed on page C-27, and are described on pages C-28 thru C-48. Switches with standard options are shown on page C-28. When selecting options and building a part number, some ordering format boxes may not be filled. Dashes, hyphens or spaces in the part number are not significant and are shown for clarity only.

All models have epoxy terminal seal and are compatible with 'bottom-wash' PC board cleaning methods. models available, see page C-29.

Hardware: two each—mounting screws, nuts, lockwashers and standoffs for 1/8 in. thick panel are supplied standard on switches with panel mounting brackets. Hardware for other panel thicknesses also available. Actuators, frames and mounting hardware are available separately, see catalog section H.

SPECIFICATIONS

CONTACT RATING: 5 AMPS @ 120 V AC or 28 V DC; 2 AMPS @ 250 V AC (Q contact material).

ELECTRICAL LIFE: 7X01 and UX1 MODELS: 100,000 make-and-break cycles at full load. All other models, 40,000 cycles.

CONTACT RESISTANCE: Below 10 milliohms typ. initial @ 2-4 V DC, 100 mA, for both silver and gold plated contacts.

INSULATION RESISTANCE: 10⁹ ohms min.

DIELECTRIC STRENGTH: 1,000 V RMS min. @ sea level.

OPERATING TEMPERATURE: -30°C to 85°C.

SOLDERABILITY: Per MIL-STD-202F method 208D, or EIA RS-186E method 9 (1 hour steam aging).

NOTE: Specifications and materials listed above are general specifications. Specifications available for specific and custom switches, consult factory.

MATERIALS

CASE: Glass filled nylon 6/6, flame retardant, heat stabilized, or diallyl phthalate (DAP) (UL 94V-0).

ACTUATOR: Nylon, black standard.

FRAME—FRONT MOUNT: Nylon, black standard.
REAR MOUNT: Spring steel, black standard.

BUSHING: Brass or zinc, nickel plated.

HOUSING: Stainless steel.

SWITCH SUPPORT: Brass or steel, tin plated.

END CONTACTS: Coin silver, silver plated (Q contact material).

CENTER CONTACTS & ALL TERMINALS: Copper alloy, silver plated (Q contact material).

TERMINAL SEAL: Epoxy

HARDWARE: Nut, Screw, & Lockwasher—Stainless steel.

Standoff—Nylon standard. Aluminum available, consult factory.