

# International IOR Rectifier

## 123NQ100PbF

SCHOTTKY RECTIFIER

120Amp

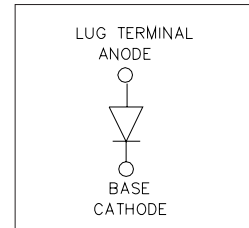

### Major Ratings and Characteristics

Characteristics	Values	Units
$I_{F(AV)}$ Rectangular waveform	120	A
$V_{RRM}$	100	V
$I_{FSM}$ @ $t_p = 5 \mu s$ sine	12800	A
$V_F$ @120Apk, $T_J = 125^\circ C$	0.73	V
$T_J$ range	-55 to 175	$^\circ C$

### Description/ Features

The 123NQ.. high current Schottky rectifier module series has been optimized for low reverse leakage at high temperature. The proprietary barrier technology allows for reliable operation up to 175 °C junction temperature. Typical applications are in high current switching power supplies, plating power supplies, UPS systems, converters, free-wheeling diodes, welding, and reverse battery protection.

- 175 °C  $T_J$  operation
- Low forward voltage drop
- High frequency operation
- Guard ring for enhanced ruggedness and long term reliability
- Lead-Free

### Case Styles



HALF-PAK (D-67)

## Voltage Ratings

Part number	123NQ100PbF
$V_R$ Max. DC Reverse Voltage (V)	100
$V_{RWM}$ Max. Working Peak Reverse Voltage (V)	

## Absolute Maximum Ratings

Parameters	123NQ	Units	Conditions
$I_{F(AV)}$ Max. Average Forward Current * See Fig. 5	120	A	50% duty cycle @ $T_C = 133^\circ\text{C}$ , rectangular wave form
$I_{FSM}$ Max. Peak One Cycle Non-Repetitive Surge Current * See Fig. 7	12800	A	Following any rated load condition and with rated $V_{RRM}$ applied
	1800		
$E_{AS}$ Non-Repetitive Avalanche Energy	15	mJ	$T_J = 25^\circ\text{C}$ , $I_{AS} = 5.5$ Amps, $L = 1$ mH
$I_{AR}$ Repetitive Avalanche Current	1	A	Current decaying linearly to zero in 1 $\mu\text{sec}$ Frequency limited by $T_J$ max. $V_A = 1.5 \times V_R$ typical

## Electrical Specifications

Parameters	123NQ	Units	Conditions
$V_{FM}$ Max. Forward Voltage Drop * See Fig. 1 (1)	0.91	V	@ 120A
	1.26	V	@ 240A
	0.73	V	@ 120A
	0.9	V	@ 240A
$I_{RM}$ Max. Reverse Leakage Current * See Fig. 2	3	mA	$T_J = 25^\circ\text{C}$
	40	mA	$T_J = 125^\circ\text{C}$
$C_T$ Max. Junction Capacitance	2650	pF	$V_R = 5V_{DC}$ (test signal range 100Khz to 1Mhz) $25^\circ\text{C}$
$L_S$ Typical Series Inductance	7.0	nH	From top of terminal hole to mounting plane
$dv/dt$ Max. Voltage Rate of Change (Rated $V_R$ )	10000	V/ $\mu\text{s}$	

(1) Pulse Width 500 $\mu\text{s}$ 

## Thermal-Mechanical Specifications

Parameters	123NQ	Units	Conditions	
$T_J$ Max. Junction Temperature Range	-55 to 175	$^\circ\text{C}$		
$T_{stg}$ Max. Storage Temperature Range	-55 to 175	$^\circ\text{C}$		
$R_{thJC}$ Max. Thermal Resistance Junction to Case	0.38	$^\circ\text{C}/\text{W}$	DC operation * See Fig. 4	
$R_{thCS}$ Typical Thermal Resistance, Case to Heatsink	0.05	$^\circ\text{C}/\text{W}$	Mounting surface, smooth and greased	
wt Approximate Weight	30 (1.06)	g (oz.)		
T Mounting Torque	Min.	3 (26.5)	Non-lubricated threads	
	Max.	4 (35.4)		
	Terminal Torque	Min.		3.4 (30)
		Max.		5 (44.2)
Case Style	HALF PAK Module			

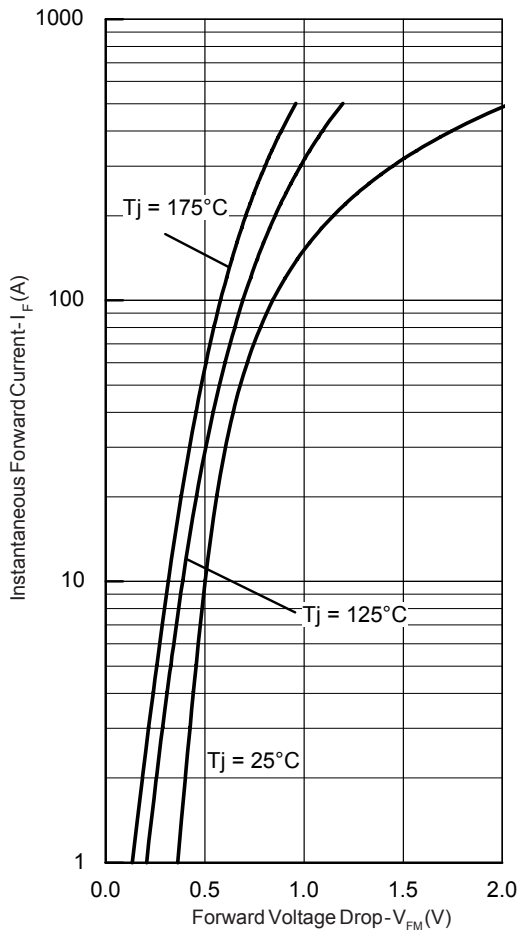

Fig. 1 - Max. Forward Voltage Drop Characteristics

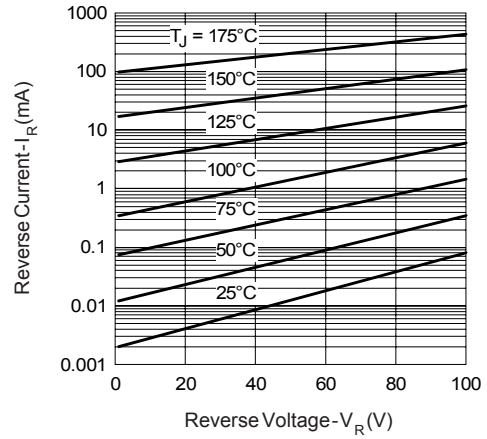

Fig. 2 - Typical Values Of Reverse Current Vs. Reverse Voltage

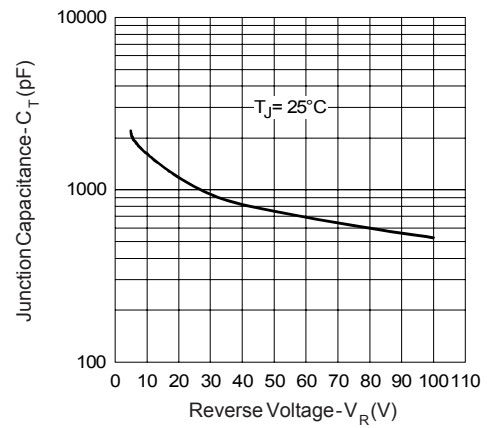

Fig. 3 - Typical Junction Capacitance Vs. Reverse Voltage

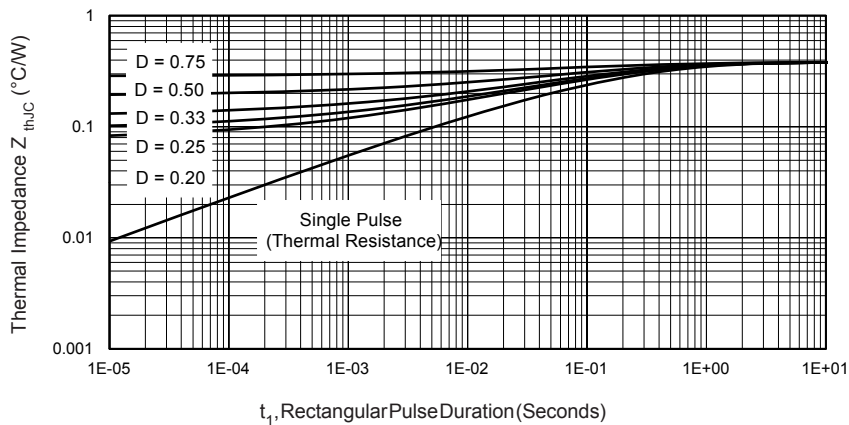

Fig. 4 - Max. Thermal Impedance  $Z_{thJC}$  Characteristics

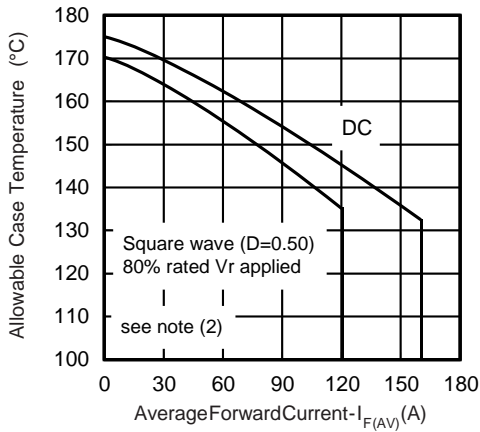

Fig. 5- Max. Allowable Case Temperature Vs. Average Forward Current

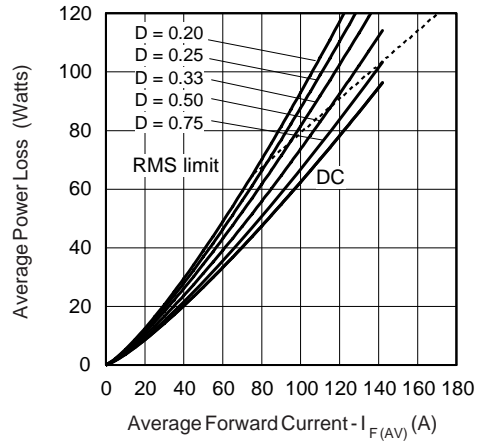

Fig. 6- Forward Power Loss Characteristics

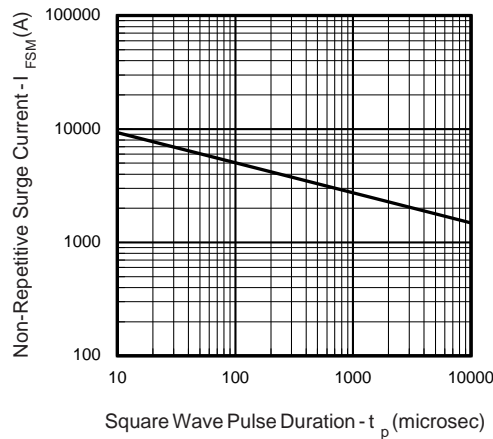

Fig. 7- Max. Non-Repetitive Surge Current

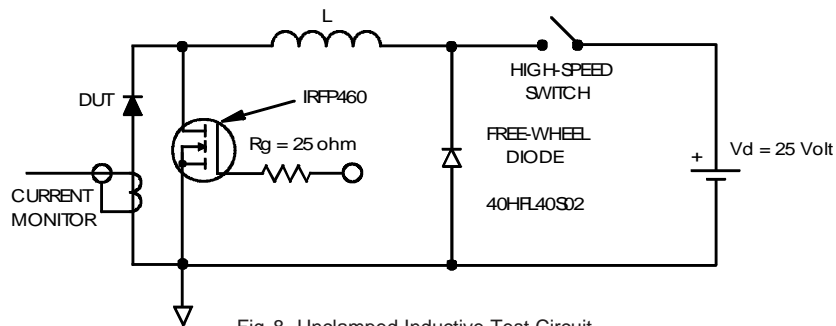

Fig. 8 - Unclamped Inductive Test Circuit

(2) Formula used:  $T_c = T_j - (P_d + P_{d_{REV}}) \times R_{thJC}$ ;

$P_d = \text{Forward Power Loss} = I_{F(AV)} \times V_{FM} @ (I_{F(AV)}/D)$  (see Fig. 6);

$P_{d_{REV}} = \text{Inverse Power Loss} = V_{R1} \times I_{R1} (1 - D)$ ;  $I_{R1} @ V_{R1} = \text{rated } V_R$

Outline Table

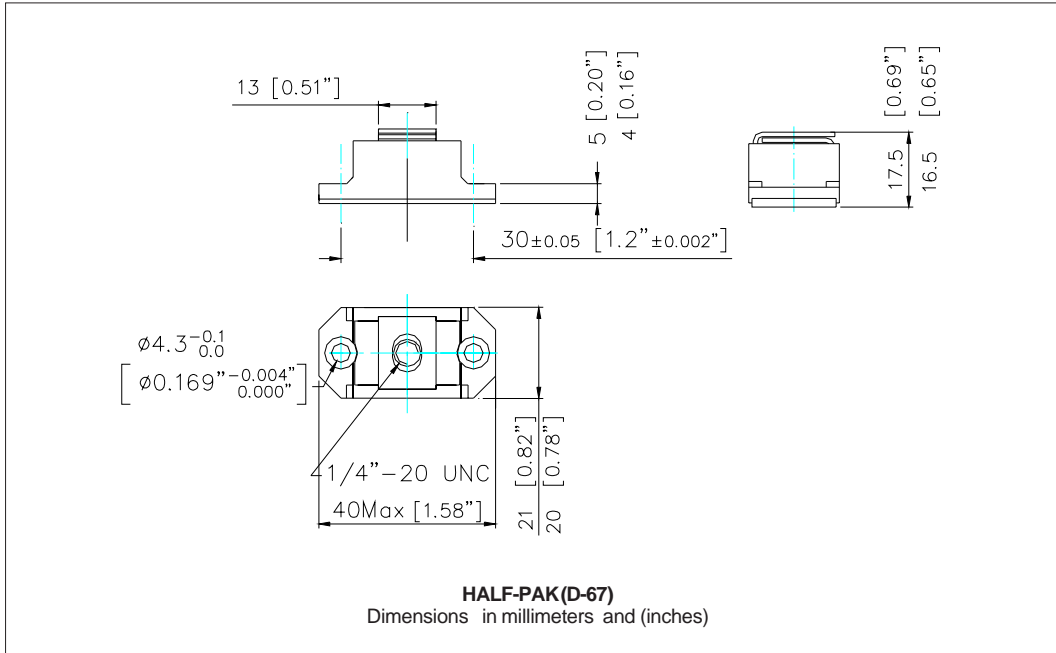

Ordering Information Table

Device Code	12	3	N	Q	100	PbF
	①	②	③	④	⑤	⑥
	<b>1</b>	-	Average Current Rating (x 10)			
	<b>2</b>	-	Product Silicon Identification			
	<b>3</b>	-	N = Not Isolated			
	<b>4</b>	-	Q = Schottky Rectifier Diode			
	<b>5</b>	-	Voltage Rating (100 = 100V)			
	<b>6</b>	-	Lead-Free			

123NQ100PbF

Bulletin PD-21144 rev. A 10/06

International  
**IOR** Rectifier

---

Data and specifications subject to change without notice.  
This product has been designed and qualified for Industrial Level and Lead-Free.  
Qualification Standards can be found on IR's Web site.

International  
**IOR** Rectifier

**IR WORLD HEADQUARTERS:** 233 Kansas St., El Segundo, California 90245, USA Tel: (310) 252-7105  
TAC Fax: (310) 252-7309  
Visit us at [www.irf.com](http://www.irf.com) for sales contact information. 10/06