

# International **IR** Rectifier

## SAFEIR Series 20ETS12PbF

### INPUT RECTIFIER DIODE Lead-Free ("PbF" suffix)

	$V_F < 1V @ 10A$ $I_{FSM} = 300A$ $V_{RRM} = 1200V$
---	---

#### Description/ Features

The 20ETS12PbF rectifier **SAFEIR** series has been optimized for very low forward voltage drop, with moderate leakage. The glass passivation technology used has reliable operation up to 150°C junction temperature.

Typical applications are in input rectification and these products are designed to be used with International Rectifier Switches and Output Rectifiers which are available in identical package outlines.

#### Output Current in Typical Applications

Applications	Single-phase Bridge	Three-phase Bridge	Units
Capacitive input filter $T_A = 55^\circ C$ , $T_J = 125^\circ C$ , common heatsink of $1^\circ C/W$	16.3	21	A

#### Major Ratings and Characteristics

Characteristics	Values	Units
$I_{F(AV)}$ Sinusoidal waveform	20	A
$V_{RRM}$	1200	V
$I_{FSM}$	300	A
$V_F @ 10A, T_J = 25^\circ C$	1.0	V
$T_J$	-40 to 150	°C

#### Package Outline



## Voltage Ratings

Part Number	$V_{RRM}$ , maximum peak reverse voltage V	$V_{RSM}$ , maximum non repetitive peak reverse voltage V	$I_{RRM}$ 150°C mA
20ETS12PbF	1200	1300	1

## Absolute Maximum Ratings

Parameters	20ETS..	Units	Conditions
$I_{F(AV)}$ Max. Average Forward Current	20	A	@ $T_C = 105^\circ\text{C}$ , 180° conduction half sine wave
$I_{FSM}$ Max. Peak One Cycle Non-Repetitive Surge Current	250	A	10ms Sine pulse, rated $V_{RRM}$ applied
	300		10ms Sine pulse, no voltage reapplied
$I^2t$ Max. $I^2t$ for fusing	316	$A^2s$	10ms Sine pulse, rated $V_{RRM}$ applied
	442		10ms Sine pulse, no voltage reapplied
$I^2\sqrt{t}$ Max. $I^2\sqrt{t}$ for fusing	4420	$A^2\sqrt{s}$	$t = 0.1$ to 10ms, no voltage reapplied

## Electrical Specifications

Parameters	20ETS..	Units	Conditions
$V_{FM}$ Max. Forward Voltage Drop	1.1	V	@ 20A, $T_J = 25^\circ\text{C}$
$r_t$ Forward slope resistance	10.4	$m\Omega$	$T_J = 150^\circ\text{C}$
$V_{F(TO)}$ Threshold voltage	0.85	V	
$I_{RM}$ Max. Reverse Leakage Current	0.1	mA	$T_J = 25^\circ\text{C}$
	1.0		$T_J = 150^\circ\text{C}$

$V_R = \text{rated } V_{RRM}$

## Thermal-Mechanical Specifications

Parameters	20ETS..	Units	Conditions
$T_J$ Max. Junction Temperature Range	-40 to 150	$^\circ\text{C}$	
$T_{stg}$ Max. Storage Temperature Range	-40 to 150	$^\circ\text{C}$	
$R_{thJC}$ Max. Thermal Resistance Junction to Case	1.3	$^\circ\text{C}/\text{W}$	DC operation
$R_{thJA}$ Max. Thermal Resistance Junction to Ambient	62	$^\circ\text{C}/\text{W}$	(*) For D <sup>2</sup> Pak version
$R_{thCS}$ Typ. Thermal Resistance Case to Heatsink	0.5	$^\circ\text{C}/\text{W}$	Mounting surface, smooth and greased
wt Approximate Weight	2 (0.07)	g (oz.)	
T Mounting Torque	Min.	6 (5)	Kg-cm (lbf-in)
	Max.	12 (10)	
Case Style	TO-220AC		
Device Marking	10ETS12		

\* When mounted on 1" square (650mm<sup>2</sup>) PCB of FR-4 or G-10 material 4 oz (140μm) copper 40°C/W  
For recommended footprint and soldering techniques refer to application note #AN-994

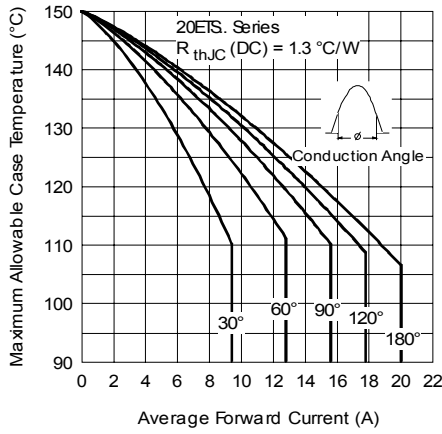

Fig. 1 - Current Rating Characteristics

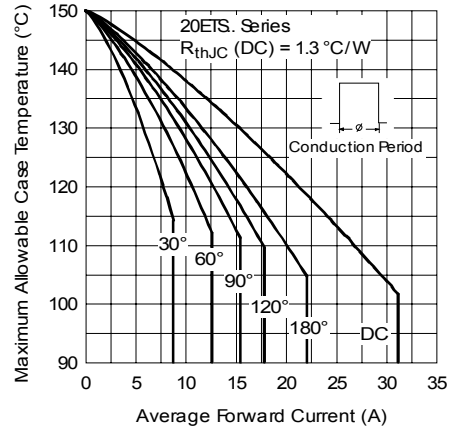

Fig. 2 - Current Rating Characteristics

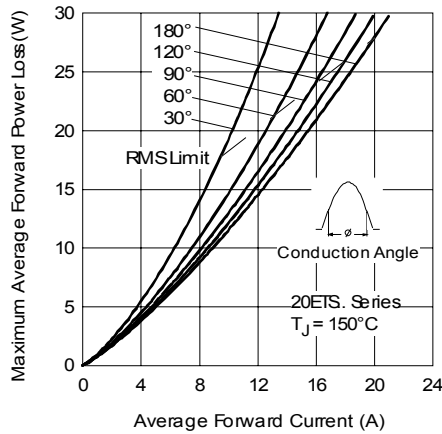

Fig. 3 - Forward Power Loss Characteristics

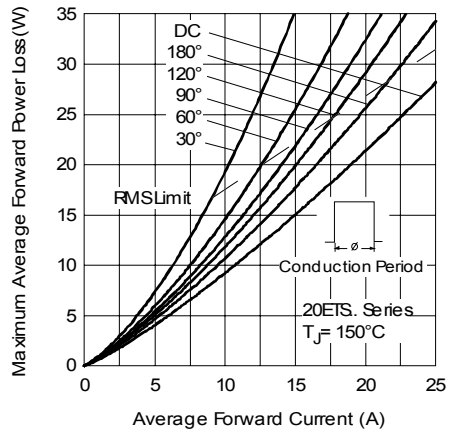

Fig. 4 - Forward Power Loss Characteristics

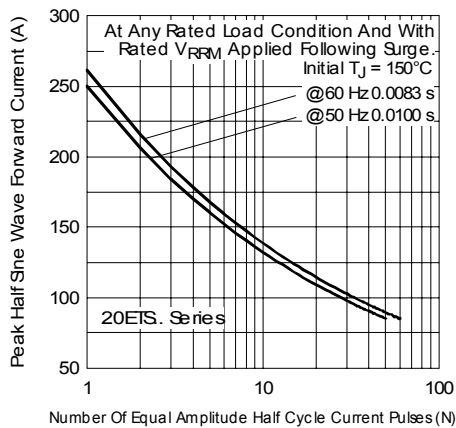

Fig. 5 - Maximum Non-Repetitive Surge Current

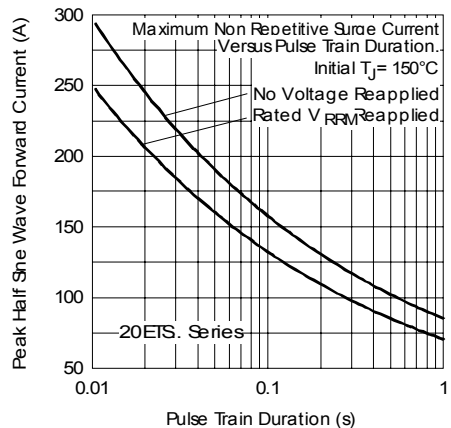

Fig. 6 - Maximum Non-Repetitive Surge Current

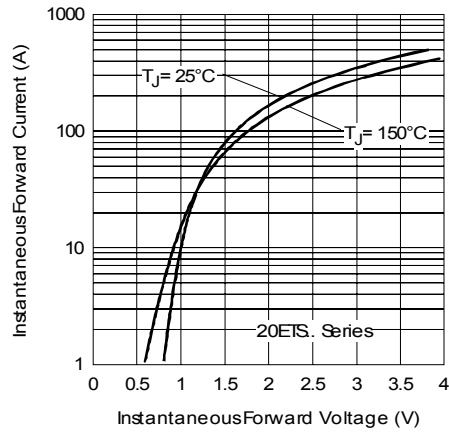

Fig. 7 - Forward Voltage Drop Characteristics

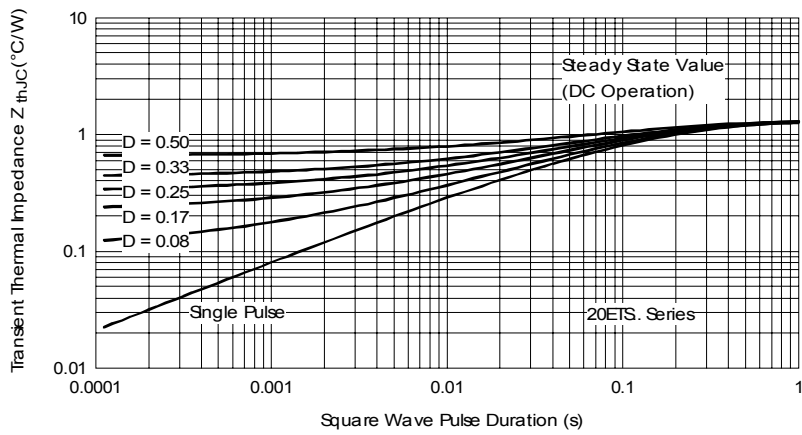
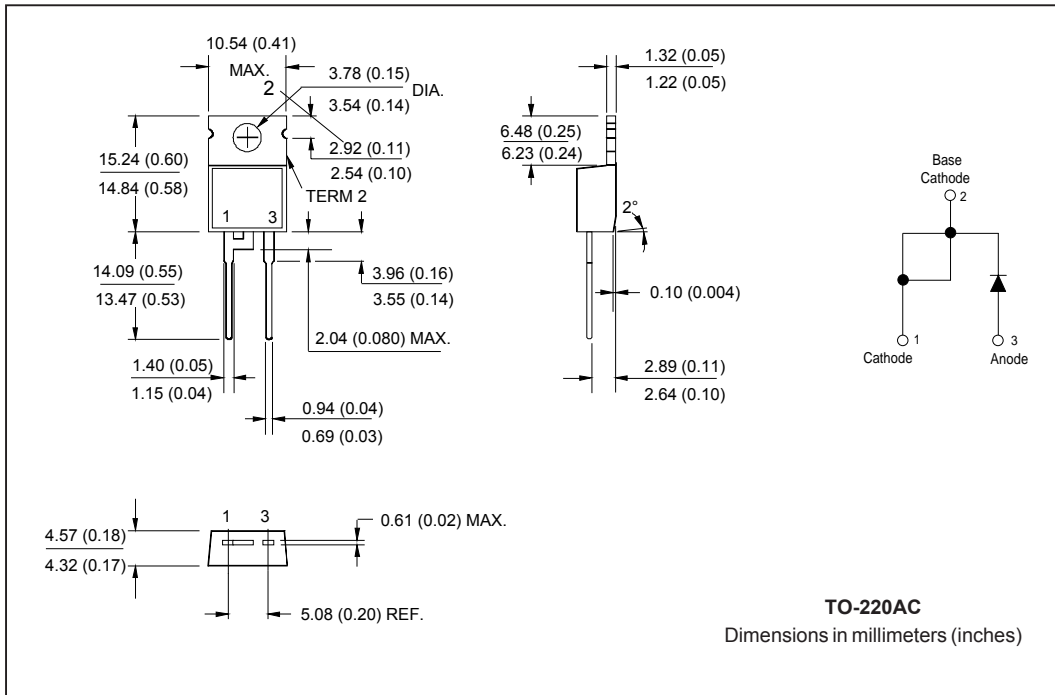
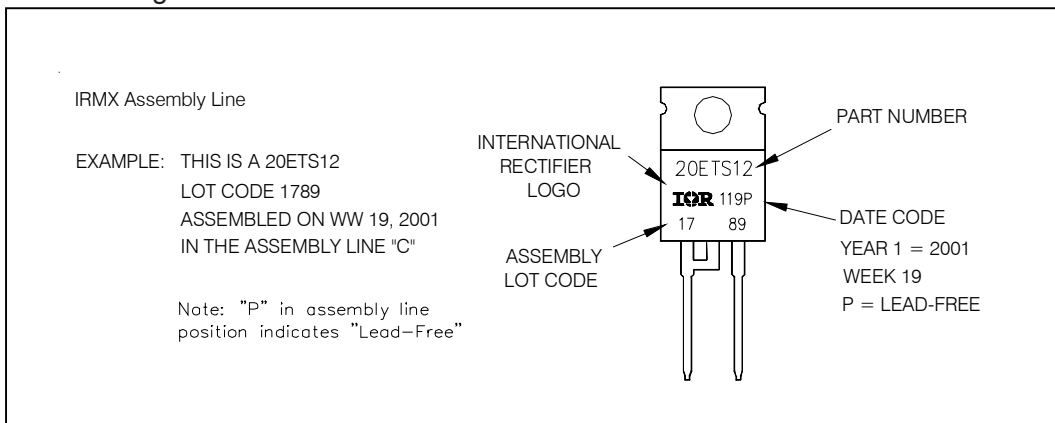

Fig. 8 - Thermal Impedance  $Z_{thjC}$  Characteristics

Outline Table



Part Marking Information



Ordering Information Table

Device Code					
20	E	T	S	12	PbF
①	②	③	④	⑤	⑥
<b>1</b>	- Current Rating (20 = 20A)				
<b>2</b>	- Circuit Configuration E = Single Diode				
<b>3</b>	- Package T = TO-220AC				
<b>4</b>	- Type of Silicon S = Standard Recovery Rectifier				
<b>5</b>	- Voltage Rating (12 = 1200V)				
<b>6</b>	- • none = Standard Production • PbF = Lead-Free				

Data and specifications subject to change without notice.  
This product has been designed and qualified for Industrial Level and Lead-Free.  
Qualification Standards can be found on IR's Web site.

International  
**IOR** Rectifier

**IR WORLD HEADQUARTERS:** 233 Kansas St., El Segundo, California 90245, USA Tel: (310) 252-7105  
TAC Fax: (310) 252-7309  
Visit us at [www.irf.com](http://www.irf.com) for sales contact information. 01/05