

IRF7404PbF

HEXFET® Power MOSFET

- Generation V Technology
- Ultra Low On-Resistance
- P-Channel Mosfet
- Surface Mount
- Available in Tape & Reel
- Dynamic dv/dt Rating
- Fast Switching
- Lead-Free

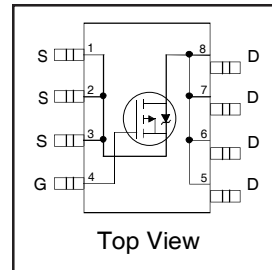

$V_{DSS} = -20V$
$R_{DS(on)} = 0.040\Omega$

Description

Fifth Generation HEXFETs from International Rectifier utilize advanced processing techniques to achieve the lowest possible on-resistance per silicon area. This benefit, combined with the fast switching speed and ruggedized device design that HEXFET Power MOSFETs are well known for, provides the designer with an extremely efficient device for use in a wide variety of applications.

The SO-8 has been modified through a customized leadframe for enhanced thermal characteristics and multiple-die capability making it ideal in a variety of power applications. With these improvements, multiple devices can be used in an application with dramatically reduced board space. The package is designed for vapor phase, infra red, or wave soldering techniques. Power dissipation of greater than 0.8W is possible in a typical PCB mount application.

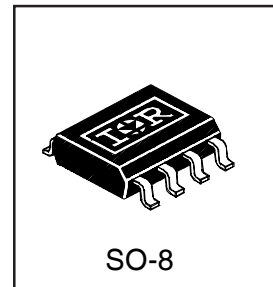

Absolute Maximum Ratings

	Parameter	Max.	Units
$I_D @ T_A = 25^\circ C$	10 Sec. Pulsed Drain Current, $V_{GS} @ -4.5V$	-7.7	A
$I_D @ T_A = 25^\circ C$	Continuous Drain Current, $V_{GS} @ -4.5V$	-6.7	
$I_D @ T_A = 70^\circ C$	Continuous Drain Current, $V_{GS} @ -4.5V$	-5.4	
I_{DM}	Pulsed Drain Current ①	-27	
$P_D @ T_A = 25^\circ C$	Power Dissipation	2.5	W
	Linear Derating Factor	0.02	W/°C
V_{GS}	Gate-to-Source Voltage	± 12	V
dv/dt	Peak Diode Recovery dv/dt ②	-5.0	V/ns
T_J, T_{STG}	Junction and Storage Temperature Range	-55 to + 150	°C

Thermal Resistance Ratings

	Parameter	Typ.	Max.	Units
$R_{\theta JA}$	Maximum Junction-to-Ambient ③	---	50	°C/W

Electrical Characteristics @ T_J = 25°C (unless otherwise specified)

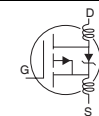
	Parameter	Min.	Typ.	Max.	Units	Conditions
V _{(BR)DSS}	Drain-to-Source Breakdown Voltage	-20	—	—	V	V _{GS} = 0V, I _D = -250μA
ΔV _{(BR)DSS/ΔT_J}	Breakdown Voltage Temp. Coefficient	—	-0.012	—	V/°C	Reference to 25°C, I _D = -1mA
R _{DS(ON)}	Static Drain-to-Source On-Resistance	—	—	0.040	Ω	V _{GS} = -4.5V, I _D = -3.2A ③
		—	—	0.060		V _{GS} = -2.7V, I _D = -2.7A ③
V _{GS(th)}	Gate Threshold Voltage	-0.70	—	—	V	V _{DS} = V _{GS} , I _D = -250μA
g _{fs}	Forward Transconductance	6.8	—	—	S	V _{DS} = -15V, I _D = -3.2A
I _{DSS}	Drain-to-Source Leakage Current	—	—	-1.0	μA	V _{DS} = -16V, V _{GS} = 0V
		—	—	-25		V _{DS} = -16V, V _{GS} = 0V, T _J = 125°C
I _{GSS}	Gate-to-Source Forward Leakage	—	—	-100	nA	V _{GS} = -12V
	Gate-to-Source Reverse Leakage	—	—	100		V _{GS} = 12V
Q _g	Total Gate Charge	—	—	50	nC	I _D = -3.2A
Q _{gs}	Gate-to-Source Charge	—	—	5.5		V _{DS} = -16V
Q _{gd}	Gate-to-Drain ("Miller") Charge	—	—	21		V _{GS} = -4.5V, See Fig. 6 and 12 ③
t _{d(on)}	Turn-On Delay Time	—	14	—	ns	V _{DD} = -10V
t _r	Rise Time	—	32	—		I _D = -3.2A
t _{d(off)}	Turn-Off Delay Time	—	100	—		R _G = 6.0Ω
t _f	Fall Time	—	65	—		R _D = 3.1Ω, See Fig. 10 ③
L _D	Internal Drain Inductance	—	2.5	—	nH	Between lead tip and center of die contact 
L _S	Internal Source Inductance	—	4.0	—		
C _{iss}	Input Capacitance	—	1500	—	pF	V _{GS} = 0V
C _{oss}	Output Capacitance	—	730	—		V _{DS} = -15V
C _{rss}	Reverse Transfer Capacitance	—	340	—		f = 1.0MHz, See Fig. 5

Source-Drain Ratings and Characteristics

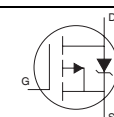
	Parameter	Min.	Typ.	Max.	Units	Conditions
I _S	Continuous Source Current (Body Diode)	—	—	-3.1	A	MOSFET symbol showing the integral reverse p-n junction diode. 
I _{SM}	Pulsed Source Current (Body Diode) ①	—	—	-27		
V _{SD}	Diode Forward Voltage	—	—	-1.0	V	T _J = 25°C, I _S = -2.0A, V _{GS} = 0V ③
t _{rr}	Reverse Recovery Time	—	69	100	ns	T _J = 25°C, I _F = -3.2A
Q _{rr}	Reverse Recovery Charge	—	71	110	μC	di/dt = 100A/μs ③
t _{on}	Forward Turn-On Time	Intrinsic turn-on time is negligible (turn-on is dominated by L _S +L _D)				

Notes:

- ① Repetitive rating; pulse width limited by max. junction temperature. (See fig. 11)
- ② I_{SD} ≤ -3.2A, di/dt ≤ -65A/μs, V_{DD} ≤ V_{(BR)DSS}, T_J ≤ 150°C
- ③ Pulse width ≤ 300μs; duty cycle ≤ 2%.
- ④ Surface mounted on FR-4 board, t ≤ 10sec.

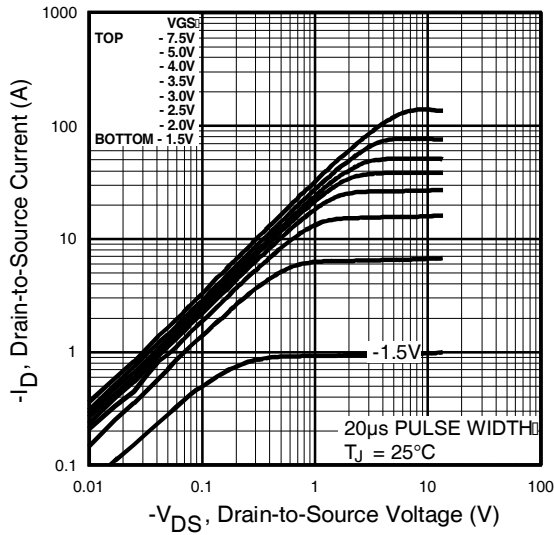

Fig 1. Typical Output Characteristics

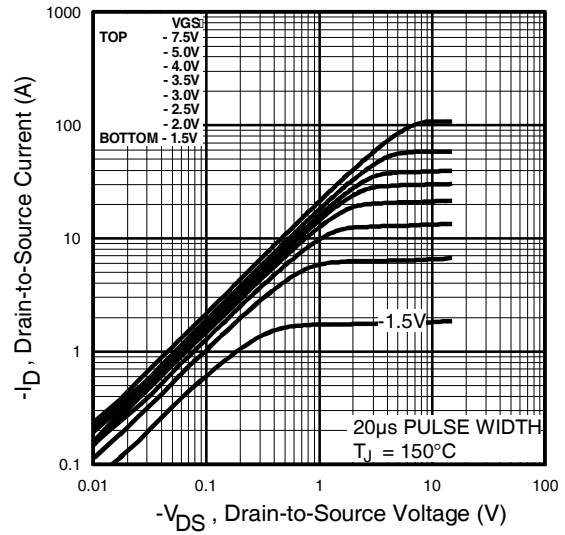

Fig 2. Typical Output Characteristics

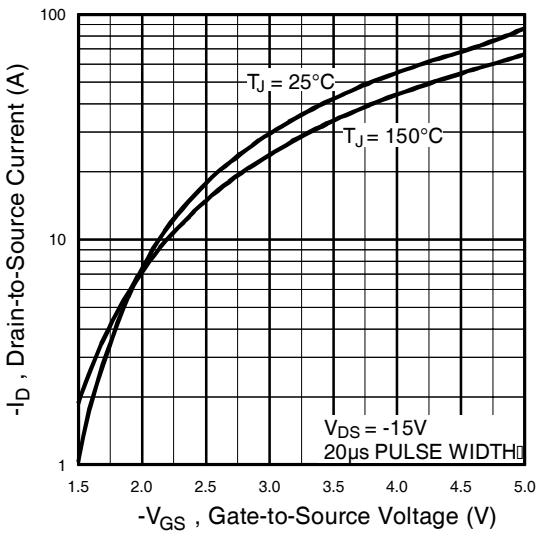

Fig 3. Typical Transfer Characteristics

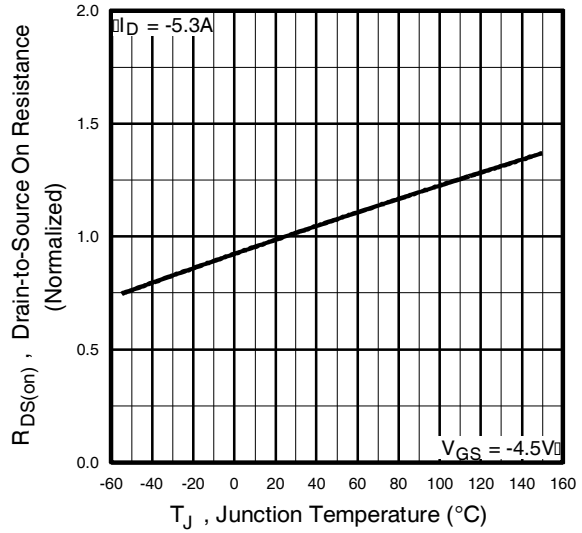

Fig 4. Normalized On-Resistance Vs. Temperature

IRF7404PbF

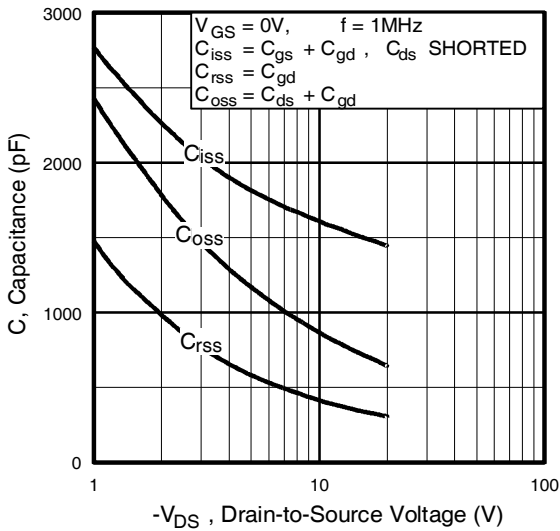

Fig 5. Typical Capacitance Vs. Drain-to-Source Voltage

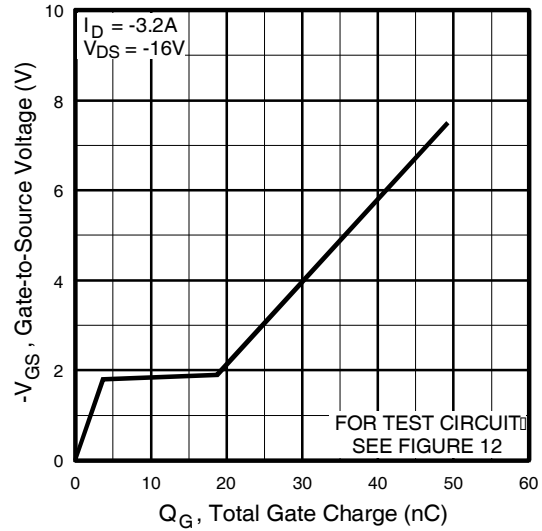

Fig 6. Typical Gate Charge Vs. Gate-to-Source Voltage

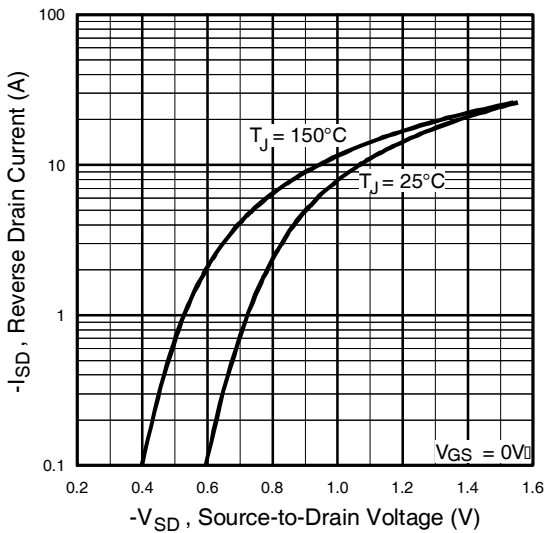

Fig 7. Typical Source-Drain Diode Forward Voltage

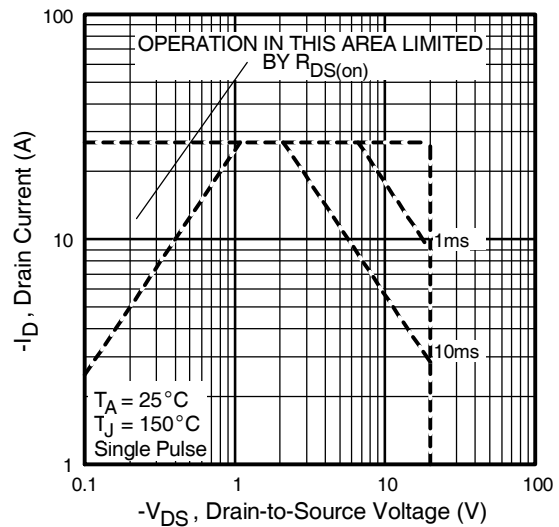

Fig 8. Maximum Safe Operating Area

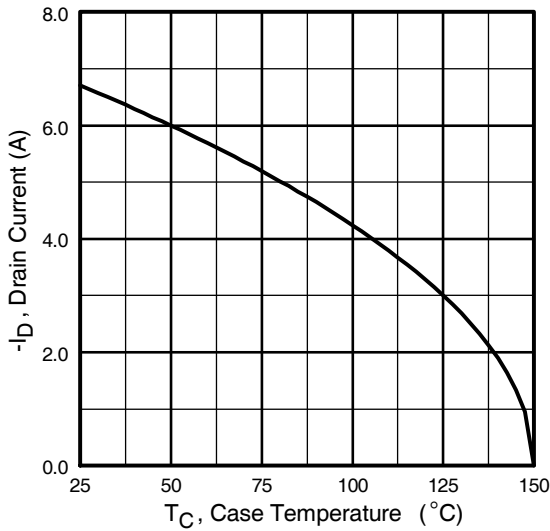

Fig 9. Maximum Drain Current Vs. Ambient Temperature

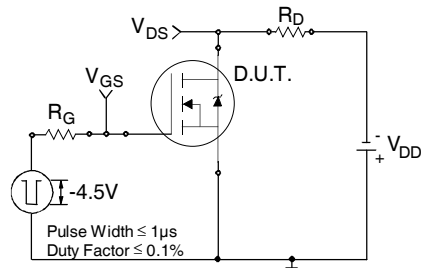

Fig 10a. Switching Time Test Circuit

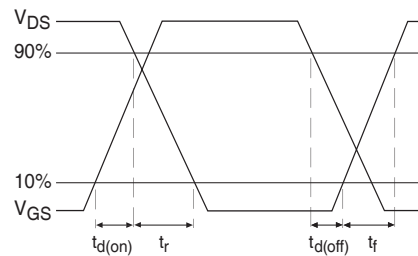

Fig 10b. Switching Time Waveforms

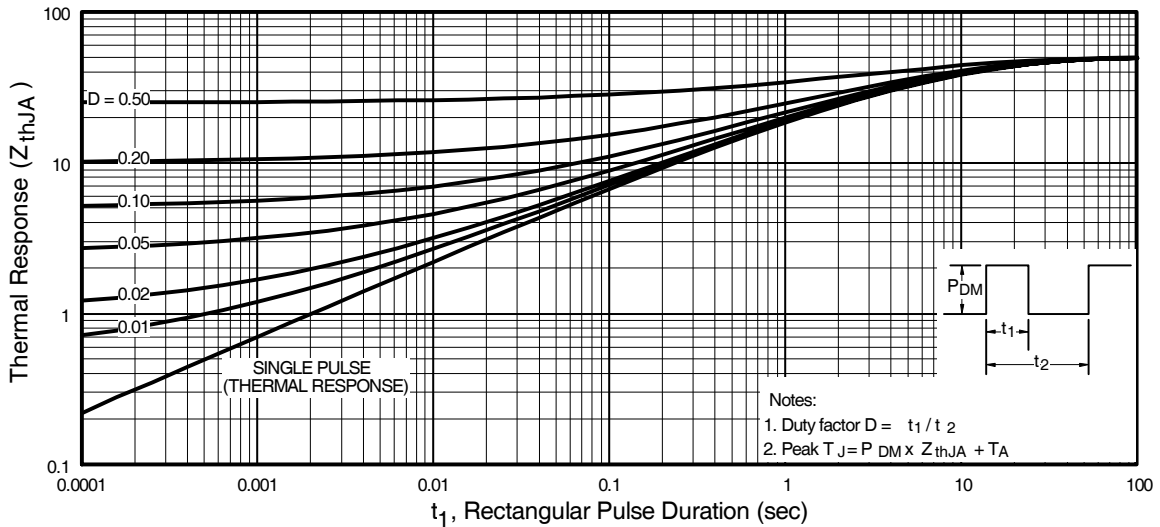

Fig 11. Maximum Effective Transient Thermal Impedance, Junction-to-Ambient

IRF7404PbF

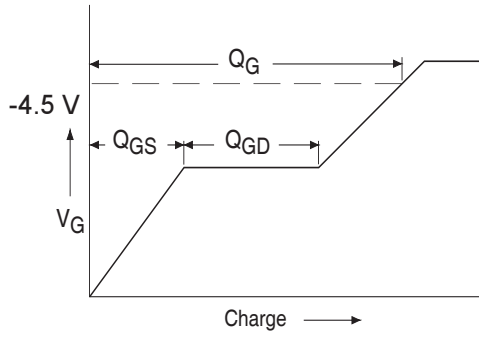

Fig 12a. Basic Gate Charge Waveform

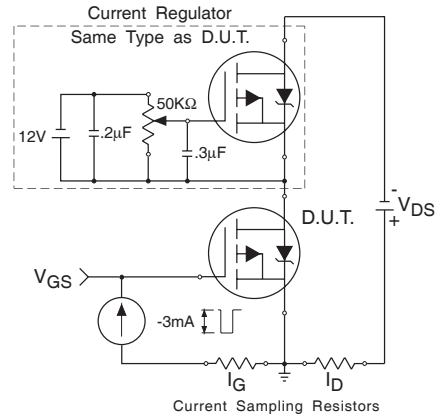
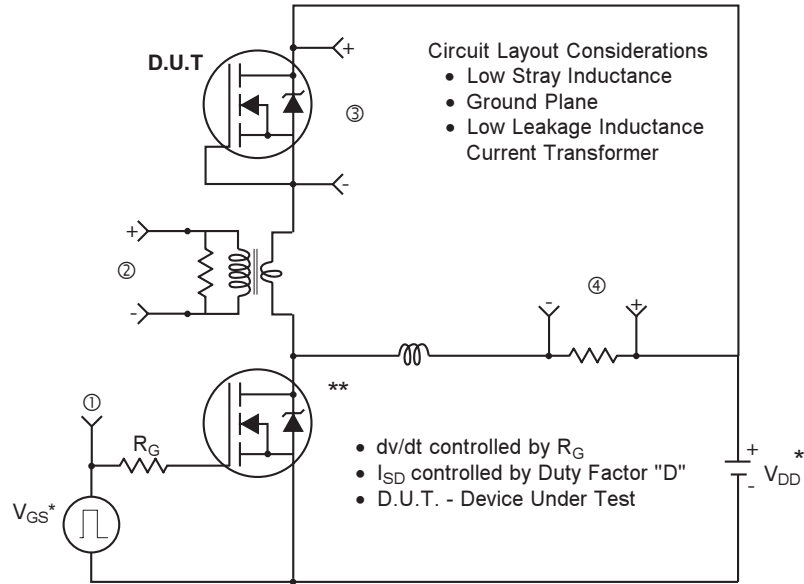

Fig 12b. Gate Charge Test Circuit

Peak Diode Recovery dv/dt Test Circuit



* Reverse Polarity for P-Channel

** Use P-Channel Driver for P-Channel Measurements

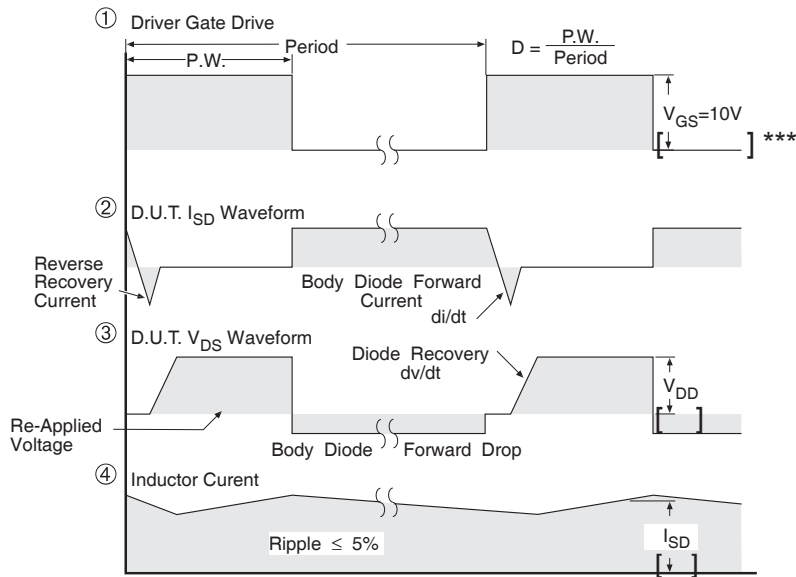

*** $V_{GS} = 5.0V$ for Logic Level and $3V$ Drive Devices

Fig 13. For P-Channel HEXFETS

IRF7404PbF

SO-8 Package Outline

Dimensions are shown in millimeters (inches)

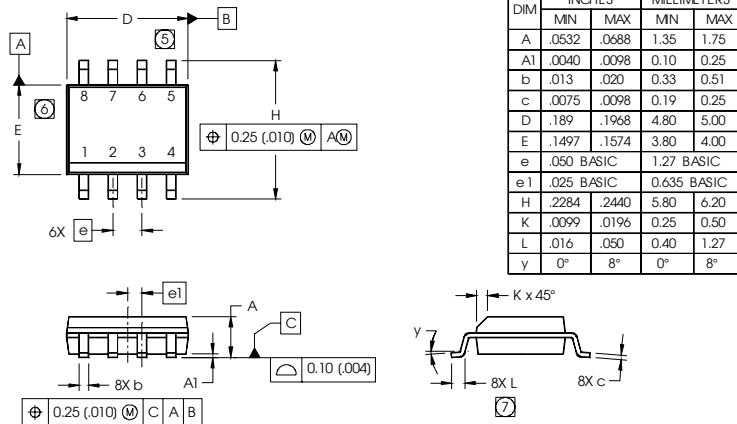

- NOTES:
1. DIMENSIONING & TOLERANCING PER ASME Y14.5M-1994.
 2. CONTROLLING DIMENSION: MILLIMETER
 3. DIMENSIONS ARE SHOWN IN MILLIMETERS (INCHES).
 4. OUTLINE CONFORMS TO JEDEC OUTLINE MS-012AA.
 5. DIMENSION DOES NOT INCLUDE MOLD PROTRUSIONS. MOLD PROTRUSIONS NOT TO EXCEED 0.15 (.006).
 6. DIMENSION DOES NOT INCLUDE MOLD PROTRUSIONS. MOLD PROTRUSIONS NOT TO EXCEED 0.25 (.010).
 7. DIMENSION IS THE LENGTH OF LEAD FOR SOLDERING TO A SUBSTRATE.

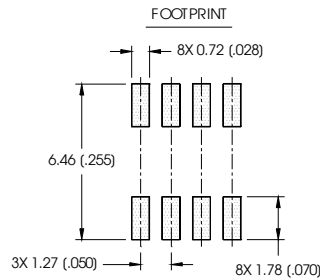

SO-8 Part Marking Information (Lead-Free)

EXAMPLE: THIS IS AN IRF7101 (MOSFET)

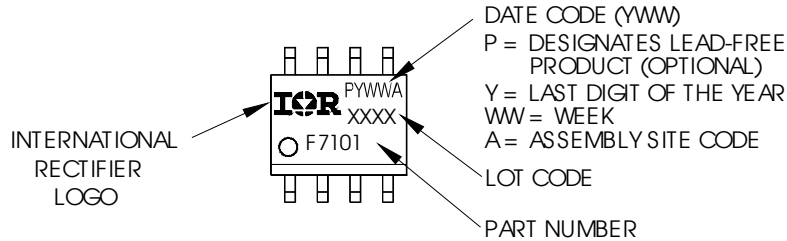

SO-8 Tape and Reel

Dimensions are shown in millimeters (inches)

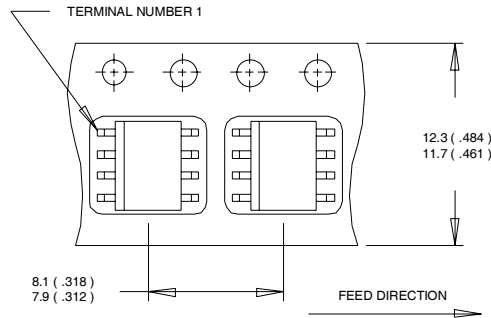

NOTES:

1. CONTROLLING DIMENSION : MILLIMETER.
2. ALL DIMENSIONS ARE SHOWN IN MILLIMETERS(INCHES).
3. OUTLINE CONFORMS TO EIA-481 & EIA-541.

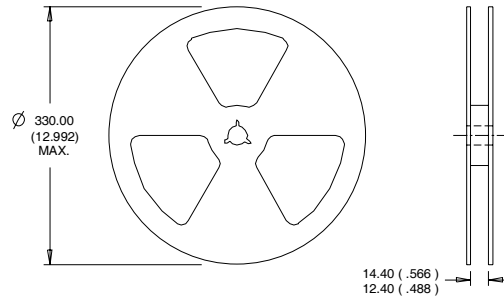

NOTES :

1. CONTROLLING DIMENSION : MILLIMETER.
2. OUTLINE CONFORMS TO EIA-481 & EIA-541.

Data and specifications subject to change without notice.
 This product has been designed and qualified for the Consumer market.
 Qualifications Standards can be found on IR's Web site.