

HVQ CONNECTOR

Board-to-board connectors

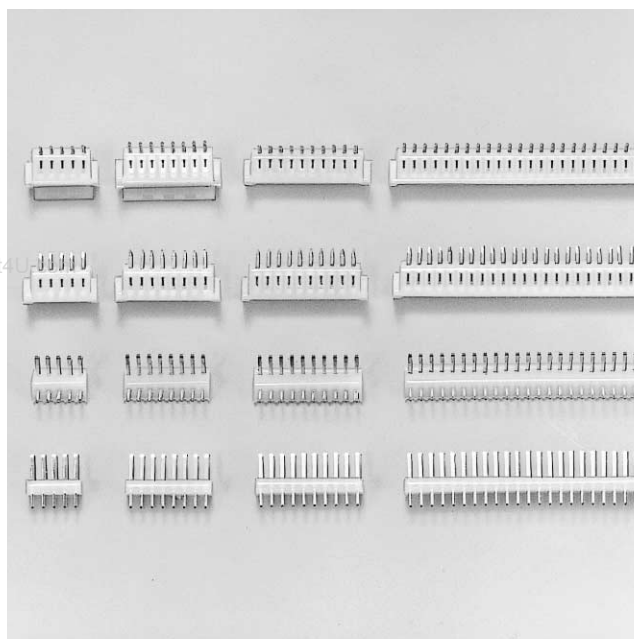

This 2.5mm (.098") pitch connector is used to interconnect printed circuit boards in parallel, vertically or horizontally.

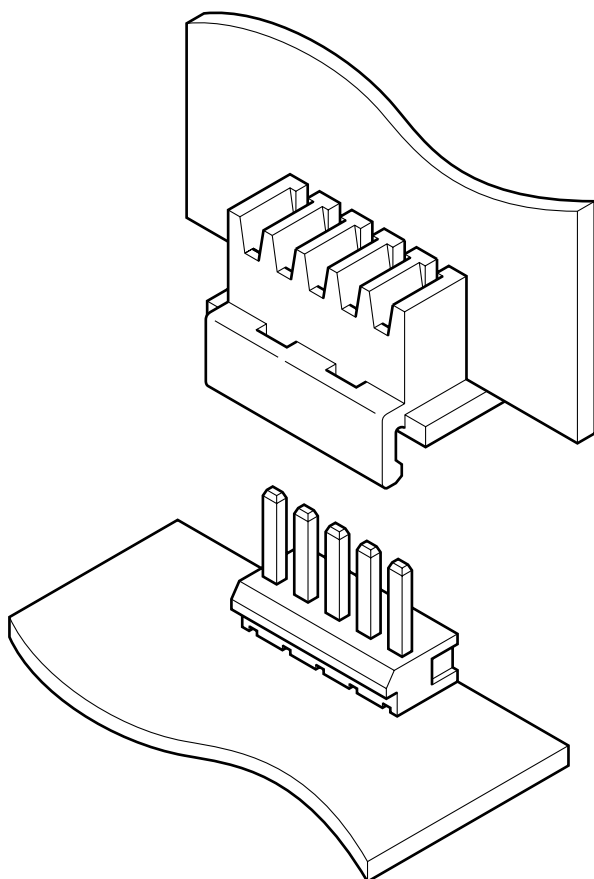

Features

• Superior folded beam construction

- (1) This sturdy construction withstands repeated stress, resists permanent deformation, and offers a very long service life.
- (2) This contact design has a large tolerance for variations in mating post thickness and resists deformation when pried.

• Whisker prevention

The header post is copper-undercoated and tin/lead-plated to prevent whiskers from being generated and to provide good solderability.

• Wide, sturdy post

The post has a large cross-sectional area to resist prying during insertion into printed circuit boards and mating with connector housings.

• Molded-in header

The posts are molded into the insulator to provide stability when mounted on printed circuit boards. This also prevents flux from entering the connector during soldering.

Specifications

- Current rating: 3A AC, DC
- Voltage rating: 250V AC, DC
- Temperature range: -25°C to +85°C
(including temperature rise in applying electrical current)
- Contact resistance: Initial value/10m Ω max.
After environmental testing/20m Ω max.
- Insulation resistance: 500M Ω min.
- Withstanding voltage: 1,500V AC/minute
- Applicable PC board thickness: 1.6mm(.063")
- * Contact JST if Lead-Free product is required.
- * Refer to "General Instruction and Notice when using Terminals and Connectors" at the end of this catalog.
- * Contact JST for details.

Standards

- Ⓜ Recognized E60389
- Ⓢ Certified LR20812

HVQ CONNECTOR

Receptacle

Top entry type with lock

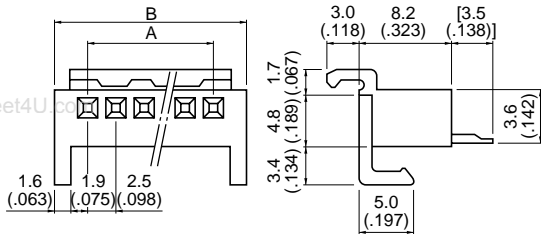

Side entry type with lock

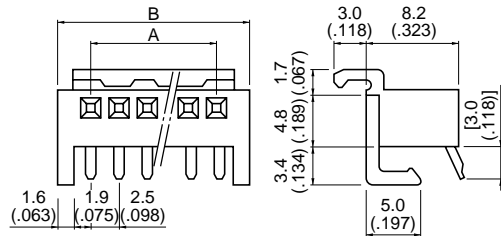

Top entry type without lock

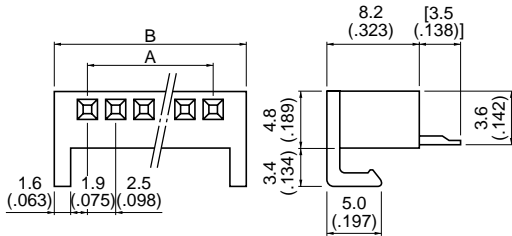

Side entry type without lock

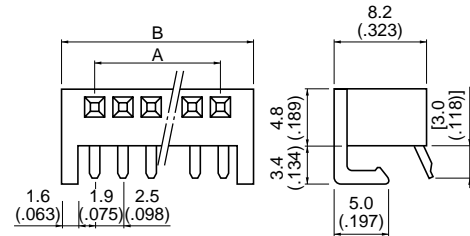

Circuits	Model No.				Dimensions mm(in.)		Q'ty / box	
	Top entry type		Side entry type		A	B	With lock	Without lock
	With lock	Without lock	With lock	Without lock				
3	–	F 3P-HVQ	–	F 3P-SHVQ	5.0 (.197)	12.0 (.472)	–	500
4	–	F 4P-HVQ	–	F 4P-SHVQ	7.5 (.295)	14.5 (.571)	–	500
5	5P-HVQ	F 5P-HVQ	5P-SHVQ	F 5P-SHVQ	10.0 (.394)	17.0 (.669)	250	250
6	6P-HVQ	F 6P-HVQ	6P-SHVQ	F 6P-SHVQ	12.5 (.492)	19.5 (.768)	250	250
7	7P-HVQ	F 7P-HVQ	7P-SHVQ	F 7P-SHVQ	15.0 (.591)	22.0 (.866)	200	250
8	8P-HVQ	F 8P-HVQ	8P-SHVQ	F 8P-SHVQ	17.5 (.689)	24.5 (.965)	200	200
9	9P-HVQ	F 9P-HVQ	9P-SHVQ	F 9P-SHVQ	20.0 (.787)	27.0(1.063)	200	200
10	10P-HVQ	F10P-HVQ	10P-SHVQ	F10P-SHVQ	22.5 (.886)	29.5(1.161)	100	200
11	11P-HVQ	F11P-HVQ	11P-SHVQ	F11P-SHVQ	25.0 (.984)	32.0(1.260)	100	150
12	12P-HVQ	F12P-HVQ	12P-SHVQ	F12P-SHVQ	27.5(1.083)	34.5(1.358)	100	150
13	–	F13P-HVQ	–	F13P-SHVQ	30.0(1.181)	37.0(1.457)	–	100
14	–	F14P-HVQ	–	F14P-SHVQ	32.5(1.280)	39.5(1.555)	–	100
15	–	F15P-HVQ	–	F15P-SHVQ	35.0(1.378)	42.0(1.654)	–	100
16	–	F16P-HVQ	–	F16P-SHVQ	37.5(1.476)	44.5(1.752)	–	100
17	–	F17P-HVQ	–	F17P-SHVQ	40.0(1.575)	47.0(1.850)	–	100
18	–	F18P-HVQ	–	F18P-SHVQ	42.5(1.673)	49.5(1.949)	–	100
19	–	F19P-HVQ	–	F19P-SHVQ	45.0(1.772)	52.0(2.047)	–	100
20	–	F20P-HVQ	–	F20P-SHVQ	47.5(1.870)	54.5(2.146)	–	100
21	–	F21P-HVQ	–	F21P-SHVQ	50.0(1.969)	57.0(2.244)	–	100
22	–	F22P-HVQ	–	F22P-SHVQ	52.5(2.067)	59.5(2.343)	–	100
23	–	F23P-HVQ	–	F23P-SHVQ	55.0(2.165)	62.0(2.441)	–	100
24	–	F24P-HVQ	–	F24P-SHVQ	57.5(2.264)	64.5(2.539)	–	100
25	–	F25P-HVQ	–	F25P-SHVQ	60.0(2.362)	67.0(2.638)	–	100

Material and Finish

Contact: Brass, tin-plated
Housing: Nylon 66, UL94V-2, natural

Shrouded header

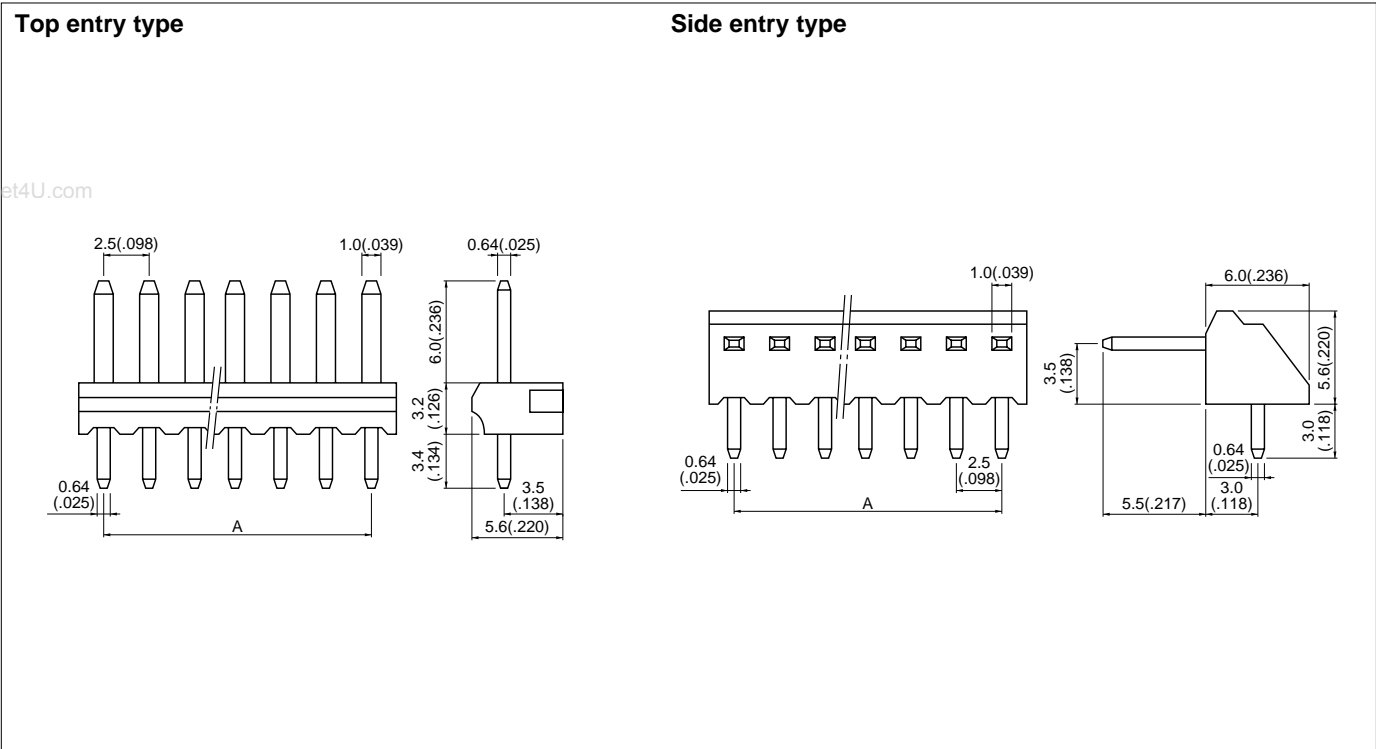

Cir- cuits	Model No.		Dimensions A mm(in.)	Q'ty / box	
	Top entry type	Side entry type		Top entry type	Side entry type
3	B 3P-SHF-1AA	BS 3P-SHF-1AA	5.0(.197)	1,000	1,000
4	B 4P-SHF-1AA	BS 4P-SHF-1AA	7.5(.295)	1,000	1,000
5	B 5P-SHF-1AA	BS 5P-SHF-1AA	10.0(.394)	1,000	1,000
6	B 6P-SHF-1AA	BS 6P-SHF-1AA	12.5(.492)	1,000	1,000
7	B 7P-SHF-1AA	BS 7P-SHF-1AA	15.0(.591)	500	500
8	B 8P-SHF-1AA	BS 8P-SHF-1AA	17.5(.689)	500	500
9	B 9P-SHF-1AA	BS 9P-SHF-1AA	20.0(.787)	500	500
10	B10P-SHF-1AA	BS10P-SHF-1AA	22.5(.886)	500	500
11	B11P-SHF-1AA	BS11P-SHF-1AA	25.0(.984)	500	500
12	B12P-SHF-1AA	BS12P-SHF-1AA	27.5(1.083)	250	200
13	B13P-SHF-1AA	BS13P-SHF-1AA	30.0(1.181)	250	200
14	B14P-SHF-1AA	BS14P-SHF-1AA	32.5(1.280)	250	200
15	B15P-SHF-1AA	BS15P-SHF-1AA	35.0(1.378)	250	200
16	B16P-SHF-1AA	BS16P-SHF-1AA	37.5(1.476)	250	200
17	B17P-SHF-1AA	BS17P-SHF-1AA	40.0(1.575)	250	200
18	B18P-SHF-1AA	BS18P-SHF-1AA	42.5(1.673)	250	200
19	B19P-SHF-1AA	BS19P-SHF-1AA	45.0(1.772)	250	200
20	B20P-SHF-1AA	BS20P-SHF-1AA	47.5(1.870)	250	200
21	B21P-SHF-1AA	BS21P-SHF-1AA	50.0(1.969)	250	200
22	B22P-SHF-1AA	BS22P-SHF-1AA	52.5(2.067)	250	200
23	B23P-SHF-1AA	BS23P-SHF-1AA	55.0(2.165)	250	200
24	B24P-SHF-1AA	BS24P-SHF-1AA	57.5(2.264)	250	200
25	B25P-SHF-1AA	BS25P-SHF-1AA	60.0(2.362)	250	200

Material and Finish

Post: Brass copper-undercoated, tin/lead-plated
 Base: Nylon 66, UL94V-0, natural

HVQ CONNECTOR

PC board layout (viewed from soldering side)

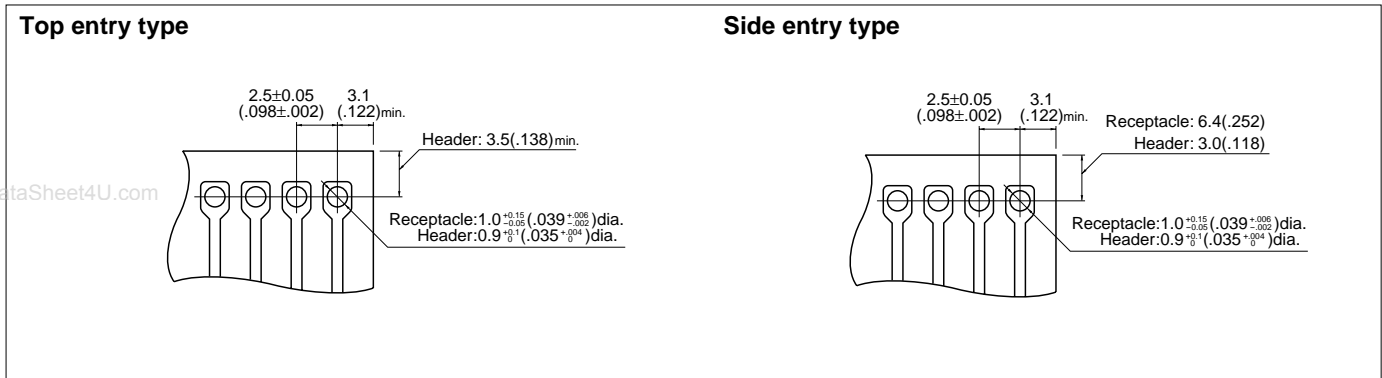

Note:
 1. Tolerances are non-cumulative: ±0.05mm(±.002") for all centers.
 2. Hole dimensions differ according to the kind of PC board and piercing method. The dimensions above should serve as a guideline. Contact JST for details.

Assembly layout

