

4 TERMINAL 2A OUTPUT LOW DROP
VOLTAGE REGULATOR

The KIA278R × × Series are Low Drop Voltage Regulator suitable for various electronic equipments.

It provides constant voltage power source with TO-220 4 terminal lead full molded PKG. The Regulator has multi function such as over current protection, overheat protection and ON/OFF control.

FEATURES

- 2.0A Output Low Drop Voltage Regulator.
- Built in ON/OFF Control Terminal.
- Built in Over Current Protection, Over Heat Protection Function.

LINE UP

ITEM	OUTPUT VOLTAGE (Typ.)	UNIT
KIA278R05PI	5	V
KIA278R06PI	6	
KIA278R08PI	8	
KIA278R09PI	9	
KIA278R10PI	10	
KIA278R12PI	12	
* KIA278R15PI	15	

* Note) * : Under Development.

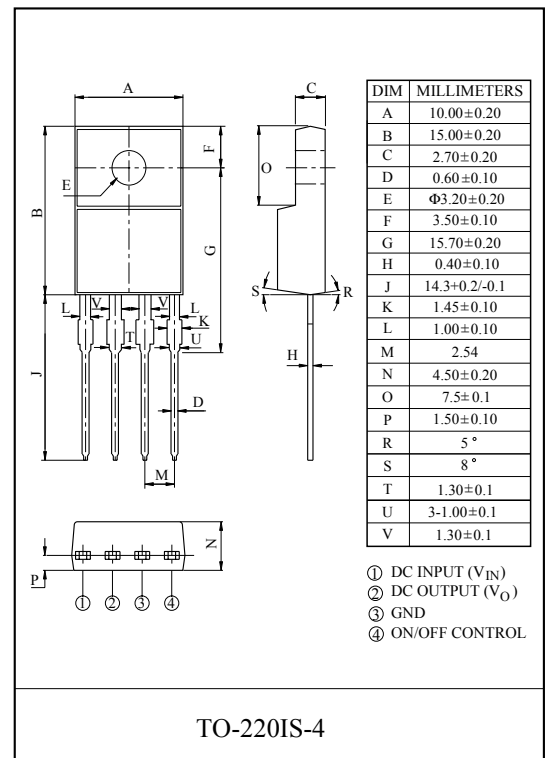
MAXIMUM RATING ($T_a=25^\circ\text{C}$)

CHARACTERISTIC	SYMBOL	RATING	UNIT	Remark
Input Voltage	V_{IN}	35	V	-
ON/OFF Control Voltage	V_C	35	V	-
Output Current	I_O	2	A	-
Power Dissipation 1	P_{d1}	1.5	W	No heatsink
Power Dissipation 2	P_{d2}	15	W	with heatsink
Junction Temperature	T_j	125	°C	-
Operating Temperature	T_{opr}	-20 ~ 80	°C	-
Storage Temperature	T_{stg}	-30 ~ 125	°C	-
Soldering Temperature (10sec)	T_{sol}	260	°C	-

KIA278R05PI~KIA278R15PI

ELECTRICAL CHARACTERISTICS (Ta=25°C)

(Unless otherwise specified, I_O=1.0A, Ta=25°C, Note1.)

CHARACTERISTIC		SYMBOL	CONDITIONS	MIN.	TYP.	MAX.	UNIT
Output Voltage	KIA278R05	V _O	-	4.88	5.0	5.12	V
	KIA278R06		-	5.85	6.0	6.15	
	KIA278R08		-	7.80	8.0	8.2	
	KIA278R09		-	8.78	9.0	9.22	
	KIA278R10		-	9.75	10.0	10.25	
	KIA278R12		-	11.70	12.0	12.30	
	KIA278R15		-	14.70	15.0	15.30	
Load Regulation		Reg Load	I _O =5mA ~ 2A	-	0.1	2.0	%
Line Regulation		Reg Line	(Note 2)	-	0.5	2.5	%
Temperature Coefficient of Output Voltage		T _C V _O	T _j =0 ~ 125°C	-	±0.02	±0.05	%/°C
Ripple Rejection		R · R	-	45	55	-	dB
Drop Out Voltage		V _D	I _O =2A	-	-	0.5	V
Output ON state for control Voltage		V _{C(ON)}	-	2.0	-	-	V
Output ON state for control Current		I _{C(ON)}	V _C =2.7V	-	-	20	μA
Output OFF state for control Voltage		V _{C(OFF)}	-	-	-	0.8	V
Output OFF state for control Current		I _{C(OFF)}	V _C =0.4V _O	-	-	-0.4	mA
Quiescent Current		I _Q	I _O =0	-	-	10	mA

Note1) V_{IN} of KIA278R05=7V

Note2) V_{IN} of KIA278R05=6 ~ 12V

Note3) At V_{IN}=0.95V_O

" KIA278R06=8V

" KIA278R06=7 ~ 15V

" KIA278R08=10V

" KIA278R08=9 ~ 25V

" KIA278R09=15V

" KIA278R09=10 ~ 25V

" KIA278R10=16V

" KIA278R10=11 ~ 26V

" KIA278R12=18V

" KIA278R12=13 ~ 29V

" KIA278R15=21V

" KIA278R15=16 ~ 32V

BLOCK DIAGRAM

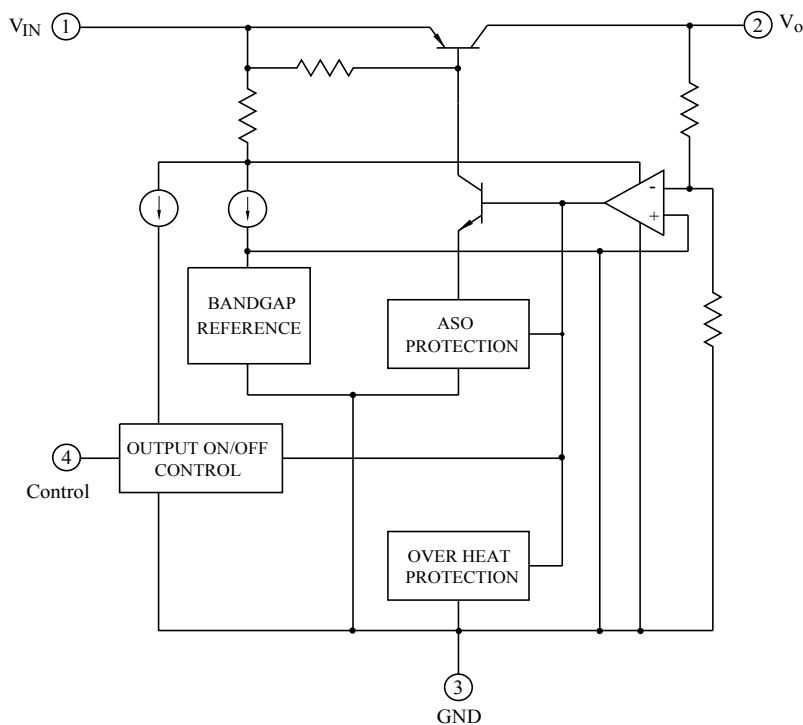

KIA278R05PI~KIA278R15PI

Fig. 1 Standard Test Circuit

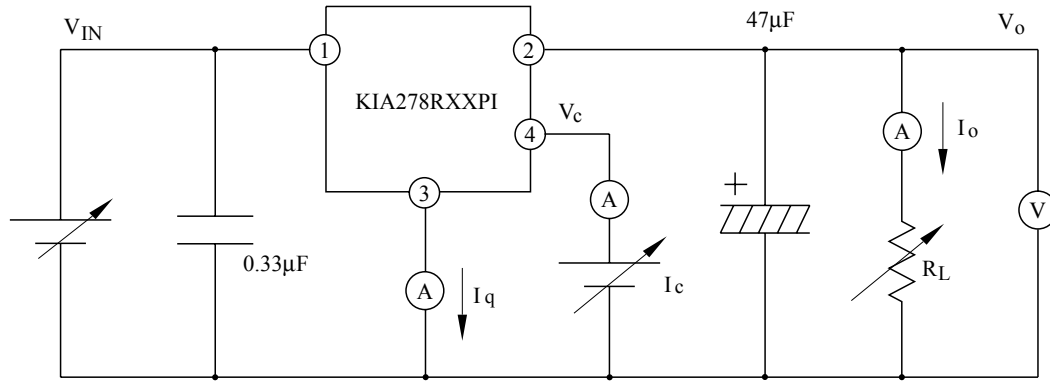

Fig. 1-2 Ripple Rejection Test Circuit

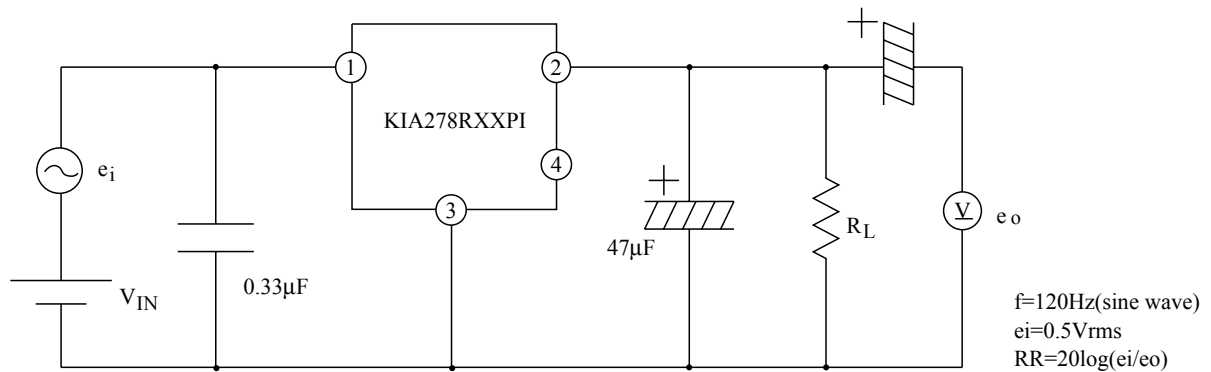
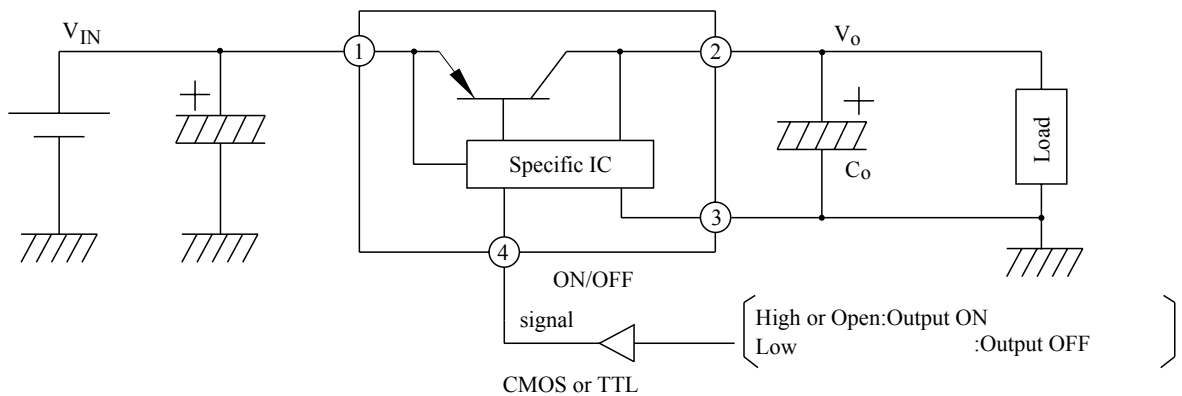
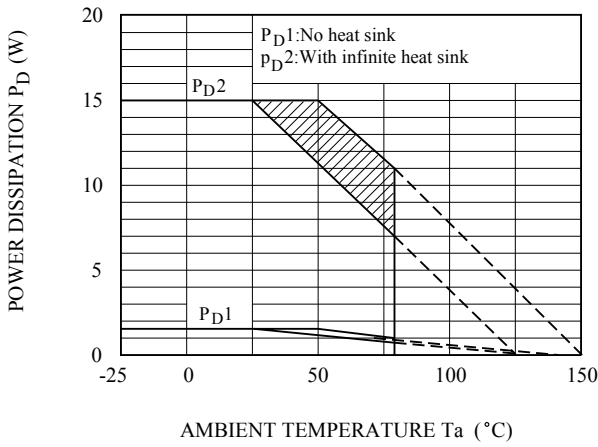

Fig. 2 Application Circuit for Standard



KIA278R05PI~KIA278R15PI

Fig.3 $T_a - P_D$



Note) Oblique line portion : Overheat protection may operate in this area.

Fig.4 $I_O - V_O$

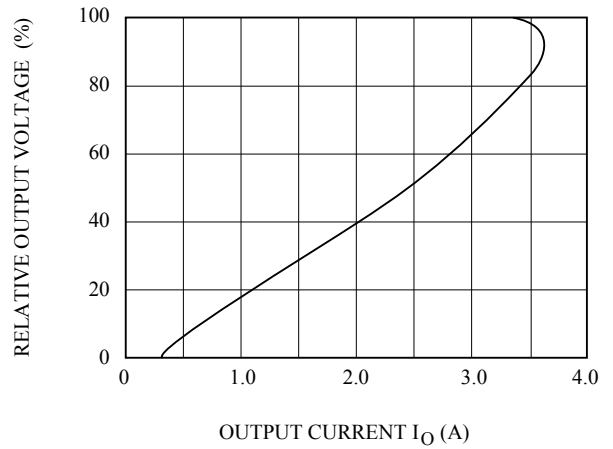

Fig.5-1 $T_j - \Delta V_O$ (KIA278R05)

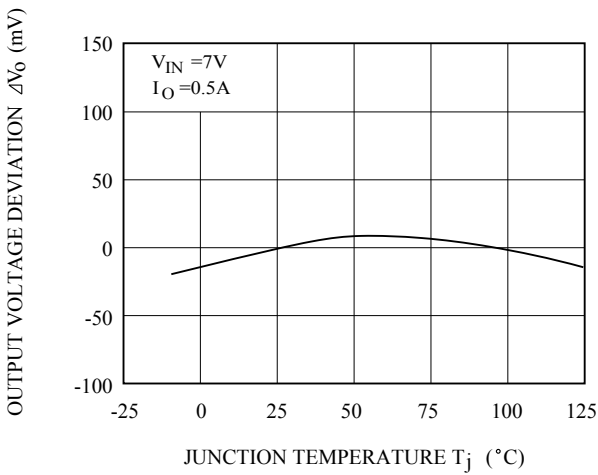

Fig.5-2 $T_j - \Delta V_O$ (KIA278R08)

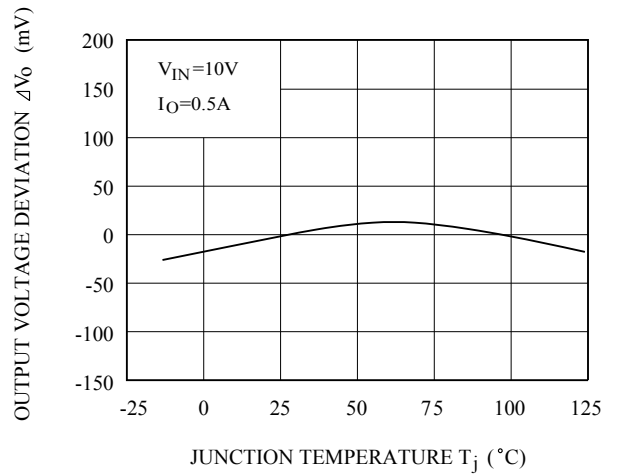

Fig.5-3 $T_j - \Delta V_O$ (KIA278R09)

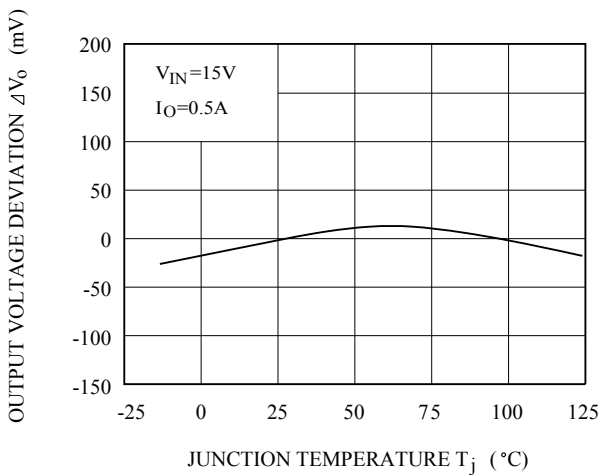
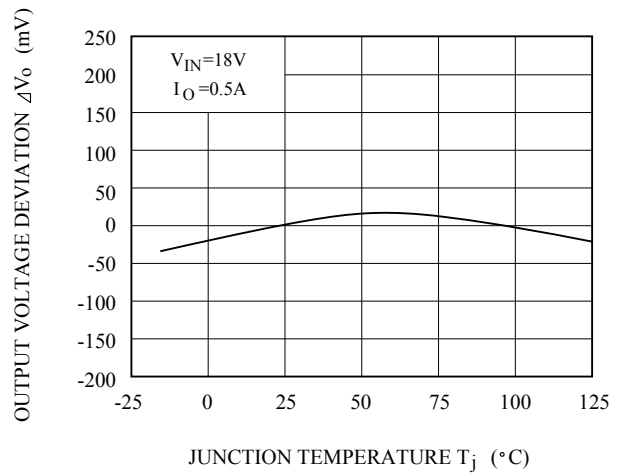

Fig.5-4 $T_j - \Delta V_O$ (KIA278R12)



KIA278R05PI~KIA278R15PI

Fig.5-5 $T_j - \Delta V_o$ (KIA278R15)

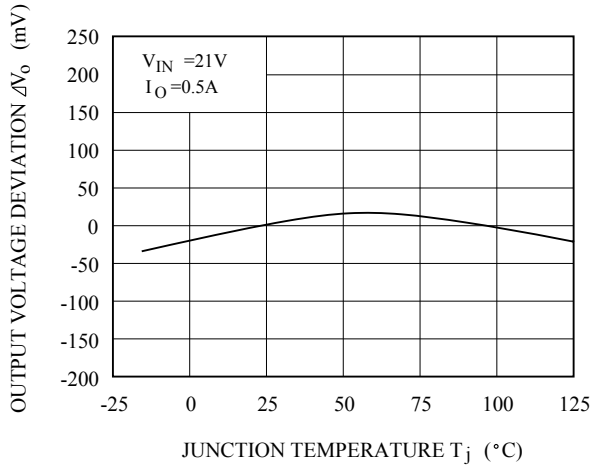

Fig.6-1 $V_{IN} - V_o$ (KIA278R05)

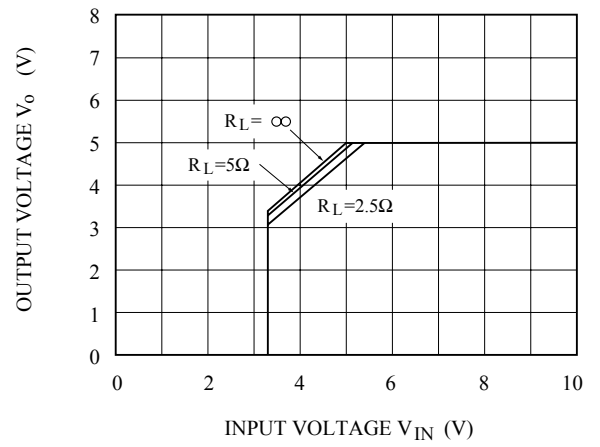

Fig.6-2 $V_{IN} - V_o$ (KIA278R08)

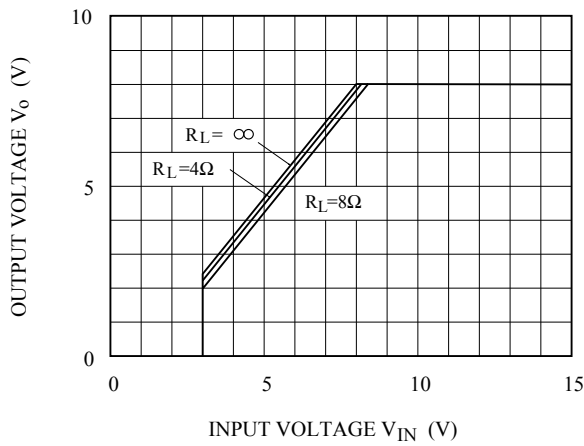

Fig.6-3 $V_{IN} - V_o$ (KIA278R09)

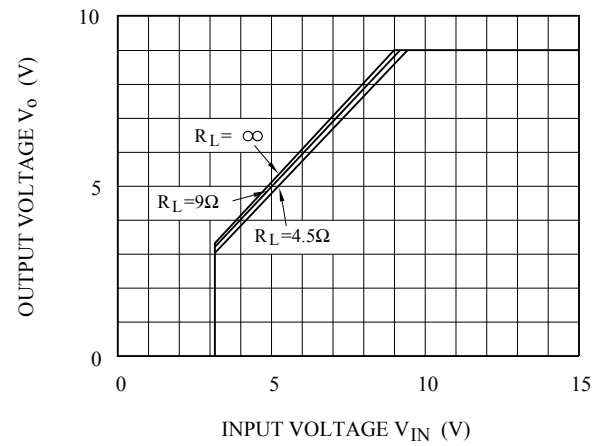

Fig.6-4 $V_{IN} - V_o$ (KIA278R12)

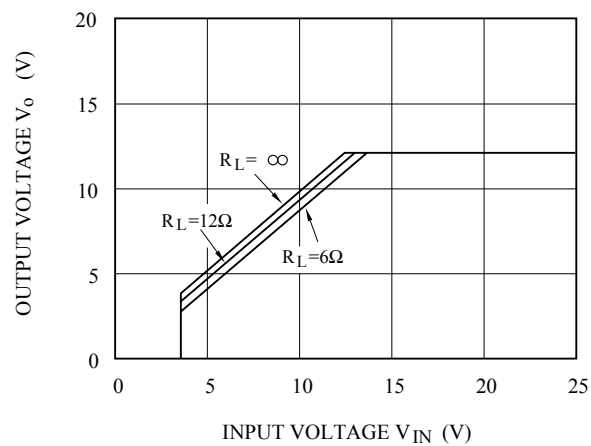
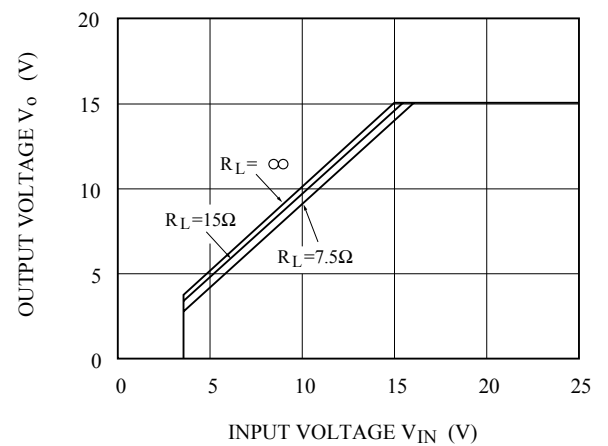

Fig.6-5 $V_{IN} - V_o$ (KIA278R15)



KIA278R05PI~KIA278R15PI

Fig.7-1 $V_{IN} - I_{BIAS}$ (KIA278R05)

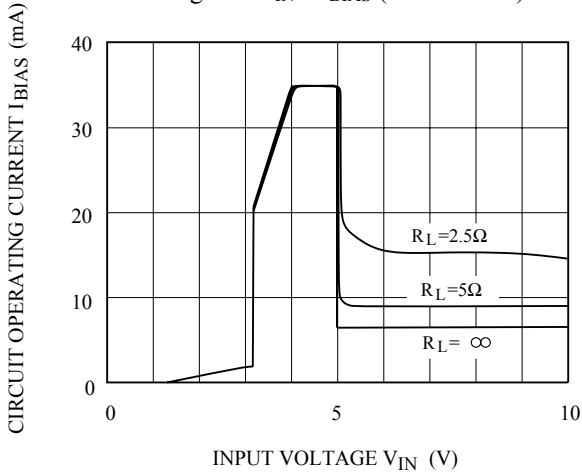

Fig.7-2 $V_{IN} - I_{BIAS}$ (KIA278R08)

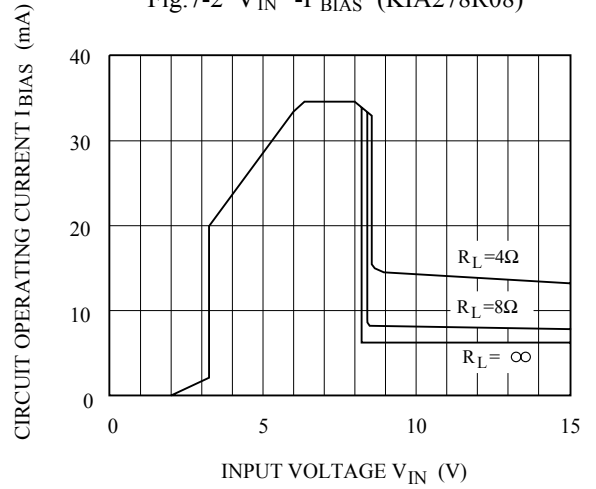

Fig.7-4 $V_{IN} - I_{BIAS}$ (KIA278R09)

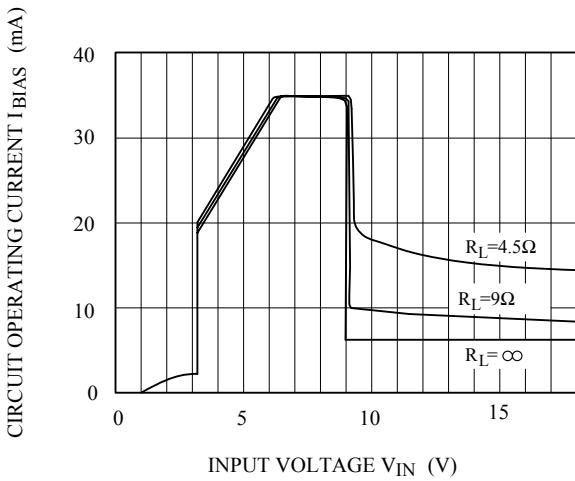

Fig.7-6 $V_{IN} - I_{BIAS}$ (KIA278R12)

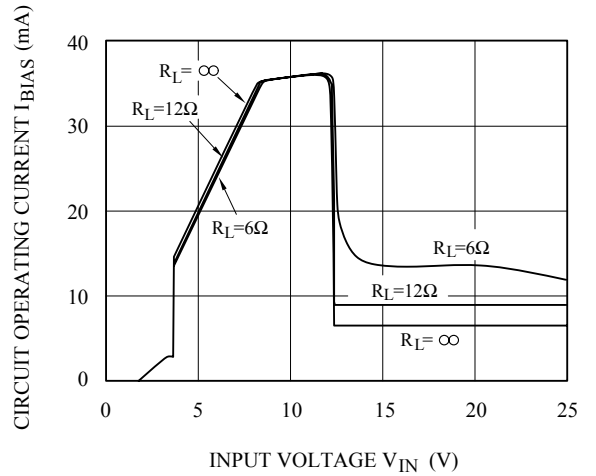

Fig.7-7 $V_{IN} - I_{BIAS}$ (KIA278R15)

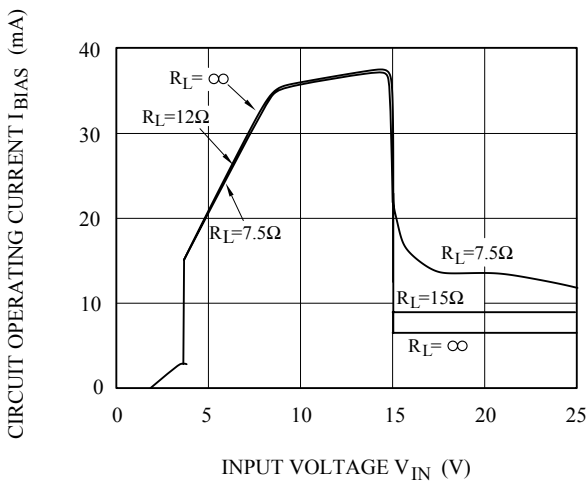
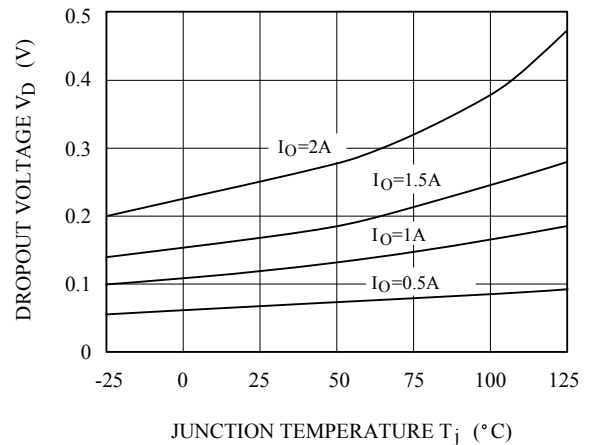

Fig.8 $T_j - V_D$



KIA278R05PI~KIA278R15PI

Fig.9 $T_j - I_q$

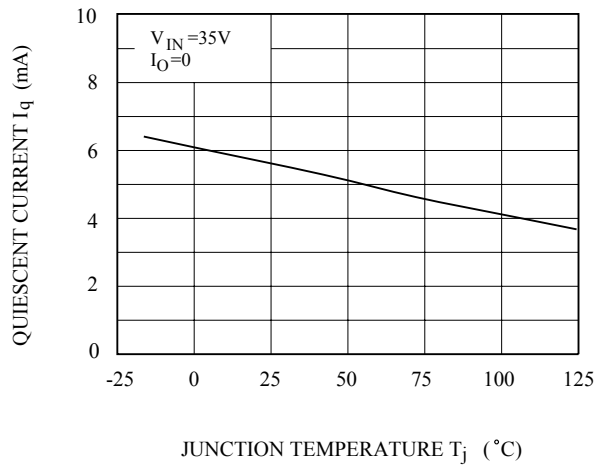

Fig. 10-1 $f - RR$

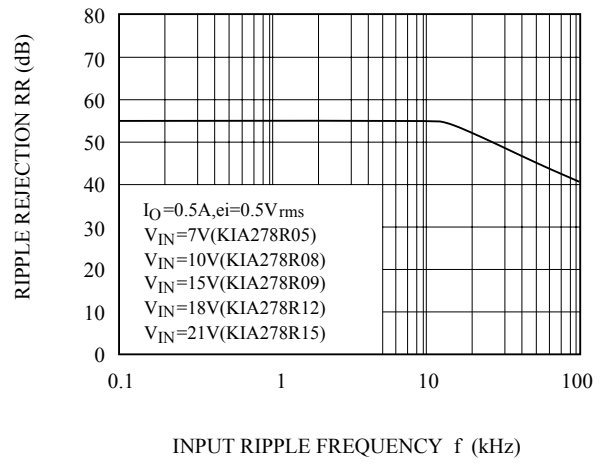

Fig.10-2 $I_O - RR$

