

**IXFN44N100P**

1000 V, 220 mΩ Polar™ HiperFET™ Power MOSFET

**Features:**

- International Standard Package
- Low Package Inductance
- Low Intrinsic Gate Resistance
- Fast Intrinsic Rectifier
- miniBLOC with Aluminum Nitride Isolation
- Low  $R_{DS(on)}$  and  $Q_G$

**Advantages:**

- High Power Density
- Space Savings
- Easy to Mount

**Applications:**

- DC-DC Converters
- AC Motor Control
- Battery Chargers
- High Speed Power Switching Application
- Switch-Mode and Resonant-Mode Power Supplies

**Product Summary**

Characteristic	Value	Unit
$V_{DSS}$	1000	V
$I_{D25}$	37	A
$R_{DS(on)}$	$\leq 220$	mΩ
$t_{rr}$	$\leq 300$	ns

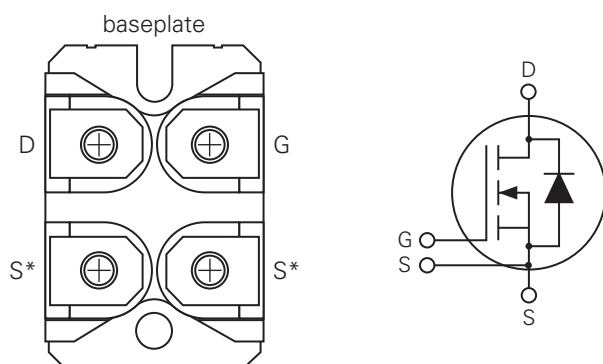
**Pinout Diagram (SOT-227B)**

**G:** Gate; **D:** Drain; **S:** Source; **baseplate:** Isolated

\* Either Source terminal can be used as main or Kelvin Source

## Maximum Ratings

Symbol	Characteristics	Conditions	Value	Units	
$V_{DSS}$	Drain-Source Voltage	$T_J = 25^\circ\text{C}$ to $150^\circ\text{C}$	1000	V	
$V_{DGR}$	Drain-Gate Voltage	$T_J = 25^\circ\text{C}$ to $150^\circ\text{C}$ , $R_{GS} = 1\text{ m}\Omega$	1000	V	
$V_{GSS}$	Gate-Source Voltage	Continuous	$\pm 30$	V	
$V_{GSM}$		Transient	$\pm 40$		
$I_{D25}$	Drain Current	$T_C = 25^\circ\text{C}$	37	A	
$I_{DM}$		$T_C = 25^\circ\text{C}$ , Pulse width limited by $T_{JM}$	110		
$I_A$	Avalanche Current	$T_C = 25^\circ\text{C}$	22	A	
$E_{AS}$	Avalanche Energy	$T_C = 25^\circ\text{C}$	2	J	
dV/dt	Reverse Diode dV/dt	$I_S \leq I_{DM}$ , $V_{DD} \leq V_{DSS}$ , $T_J \leq 150^\circ\text{C}$	20	V/ns	
$P_D$	Power Dissipation	$T_C = 25^\circ\text{C}$	890	W	
$T_J$	Operating Junction Temperature	–	-55 to +150	°C	
$T_{JM}$	Maximum Junction Temperature	–	150		
$T_{stg}$	Storage Temperature	–	-55 to +150		
$V_{ISOL}$	Isolation Voltage	50/60 Hz, RMS, $I_{ISOL} \leq 1\text{ mA}$	t = 1 min	2500	V~
			t = 1 s	3000	
$M_d$	Mounting Torque for Base Plate	–	1.5/13	Nm/lb.in	
	Terminal Connection Torque	–	1.3/11.5	Nm/lb.in	
W	Weight	–	30	g	

## Thermal Characteristics

Symbol	Characteristic	Value			Unit
		Min.	Typ.	Max.	
$R_{th, JC}$	Thermal Resistance, junction-to-case	–	–	0.14	°C/W
$R_{th, CS}$	Thermal Resistance, case to heat sink	–	0.05	–	°C/W

## Electrical Characteristics – Static ( $T_J = 25^\circ\text{C}$ unless otherwise specified)

Symbol	Characteristic	Conditions	Value			Unit
			Min.	Typ.	Max.	
$BV_{DSS}$	Drain-Source Breakdown Voltage	$I_D = 3\text{ mA}$ , $V_{GS} = 0\text{ V}$	1000	–	–	V
$V_{GS(th)}$	Gate Threshold Voltage	$I_D = 1\text{ mA}$ , $V_{GS} = V_{DS}$	3.5	–	6.5	V
$I_{GSS}$	Gate-Source Leakage Current	$V_{DS} = 0\text{ V}$ , $V_{GS} = \pm 30\text{ V}$	–	–	$\pm 200$	nA
$I_{DSS}$	Drain-Source Current	$V_{DS} = V_{DSS}$ , $V_{GS} = 0\text{ V}$	–	–	50	$\mu\text{A}$
		$V_{DS} = V_{DSS}$ , $V_{GS} = 0\text{ V}$ , $T_J = 125^\circ\text{C}$	–	–	3	mA
$R_{DS(on)}$	Drain-Source On-Resistance <sup>1</sup>	$V_{GS} = 10\text{ V}$ , $I_D = 22\text{ A}$	–	–	220	m $\Omega$

**Note 1:** Pulse test,  $t \leq 300\text{ }\mu\text{s}$ , duty cycle,  $d \leq 2\%$

**Electrical Characteristics – Dynamic** ( $T_J = 25^\circ\text{C}$  unless otherwise specified)

Symbol	Characteristic	Conditions	Value			Unit
			Min.	Typ.	Max.	
$g_{fs}$	Transconductance <sup>1</sup>	$V_{DS} = 20\text{ V}, I_D = 22\text{ A}$	20	35	–	S
$R_{Gi}$	Gate Input Resistance	–	–	1.4	–	$\Omega$
$C_{iss}$	Input Capacitance	$V_{GS} = 0\text{ V}, V_{DS} = 25\text{ V}, f = 1\text{ MHz}$	–	16.9	–	nF
$C_{oss}$	Output Capacitance		–	1100	–	pF
$C_{rss}$	Reverse Transfer Capacitance		–	184	–	pF
$Q_{g(on)}$	Total Gate Charge	$V_{GS} = 10\text{ V}, V_{DS} = 0.5 \times V_{DSS},$ $I_D = 22\text{ A}$	–	350	–	nC
$Q_{gs}$	Gate-Source Charge		–	104	–	
$Q_{gd}$	Gate-Drain Charge		–	126	–	
$t_{d(on)}$	Turn-on Delay Time	<b>Resistive Switching</b> $V_{GS} = 10\text{ V}, V_{DS} = 0.5 \times V_{DSS},$ $I_D = 22\text{ A}, R_{G(ext)} = 1\ \Omega$	–	60	–	ns
$t_r$	Rise Time		–	68	–	
$t_{d(off)}$	Turn-off Delay Time		–	90	–	
$t_f$	Fall Time		–	54	–	

**Note 1:** Pulse test,  $t \leq 300\ \mu\text{s}$ , duty cycle,  $d \leq 2\%$

**Source-Drain Diode Characteristics** ( $T_J = 25^\circ\text{C}$  unless otherwise specified)

Symbol	Characteristic	Conditions	Value			Unit
			Min.	Typ.	Max.	
$I_S$	Continuous Diode Forward Current	$V_{GS} = 0\text{ V}$	–	–	44	A
$I_{SM}$	Diode Pulse Current	Repetitive, Pulse width limited by $T_{JM}$	–	–	176	A
$V_{SD}$	Diode Forward Voltage <sup>1</sup>	$I_F = I_S, V_{GS} = 0\text{ V}$	–	–	1.5	V
$t_{rr}$	Reverse Recovery Time	$I_F = 22\text{ A}, -di/dt = 100\text{ A}/\mu\text{s},$ $V_r = 100\text{ V}, V_{GS} = 0\text{ V}$	–	–	300	ns
$Q_{rm}$	Reverse Recovery Charge		–	2.5	–	$\mu\text{C}$
$I_{rm}$	Reverse Recovery Current		–	17.0	–	A

**Note 1:** Pulse test,  $t \leq 300\ \mu\text{s}$ , duty cycle,  $d \leq 2\%$

Characteristic Curves

Fig. 1. Output Characteristics @  $T_J = 25^\circ\text{C}$

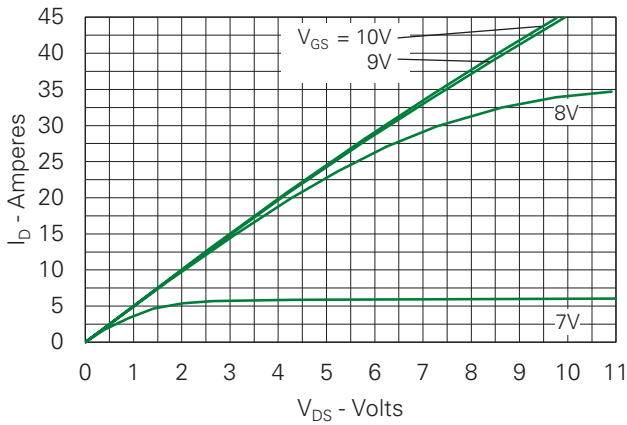

Fig. 2. Extended Output Characteristics @  $T_J = 25^\circ\text{C}$

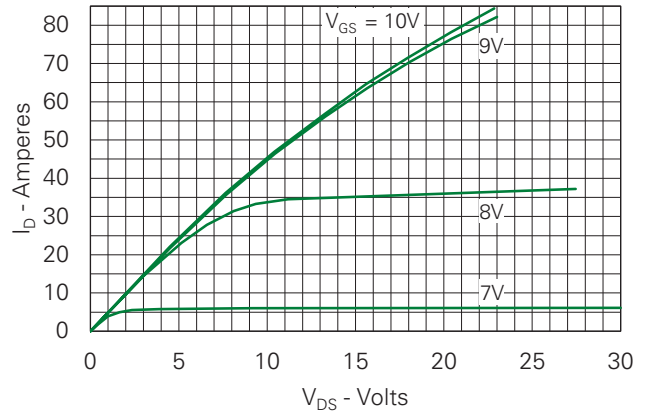

Fig. 3. Output Characteristics @  $T_J = 125^\circ\text{C}$

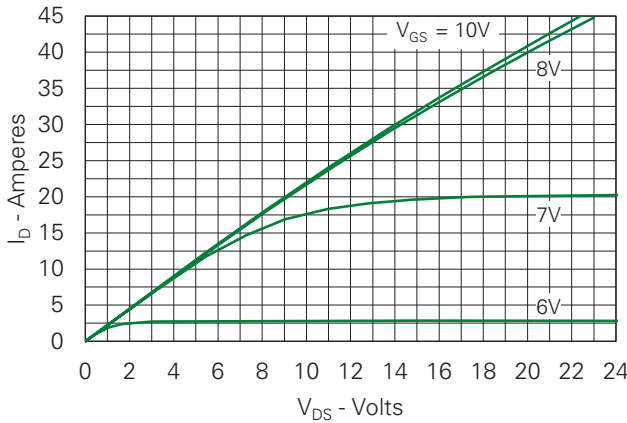

Fig. 4.  $R_{DS(on)}$  Normalized to  $I_D = 22\text{A}$  Value vs. Junction Temperature

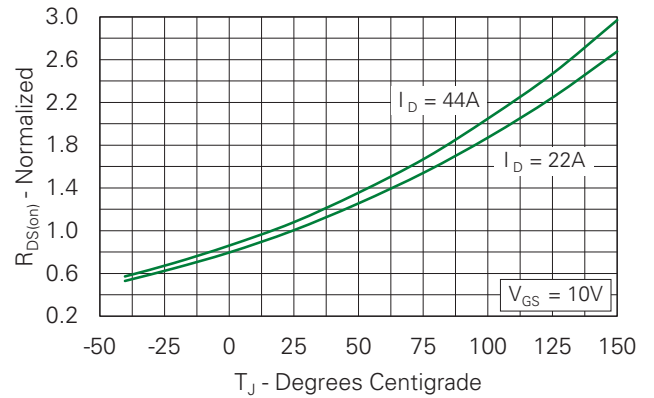

Fig. 5.  $R_{DS(on)}$  Normalized to  $I_D = 22\text{A}$  Value vs. Drain Current

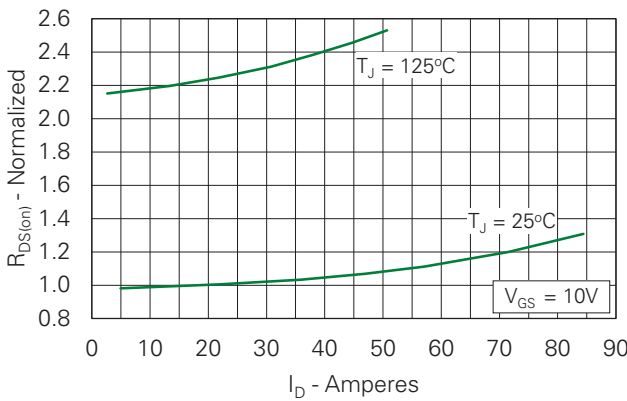

Fig. 6. Maximum Drain Current vs. Case Temperature

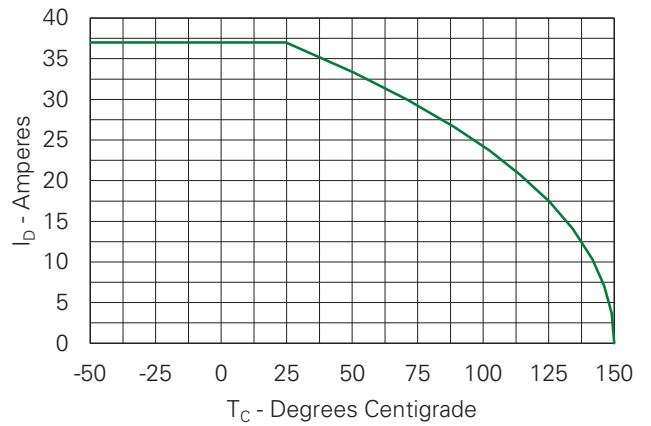

Fig. 7. Input Admittance

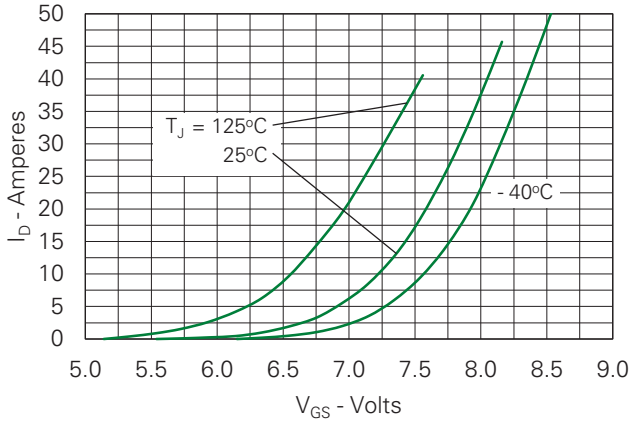

Fig. 8. Transconductance

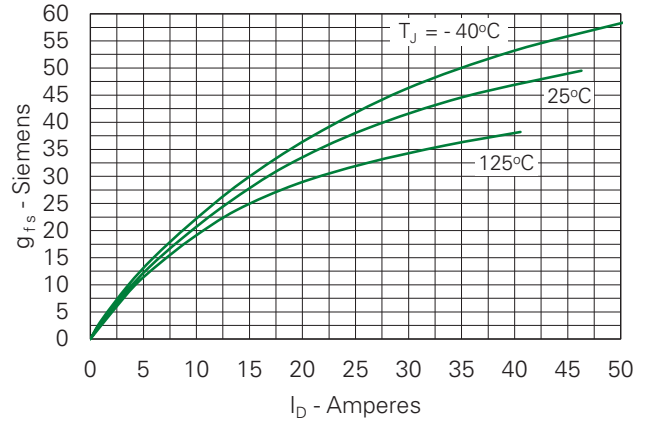

Fig. 9. Forward Voltage Drop of Intrinsic Diode

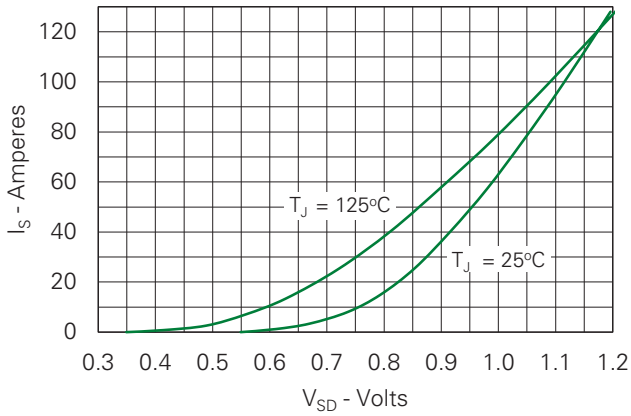

Fig. 10. Gate Charge

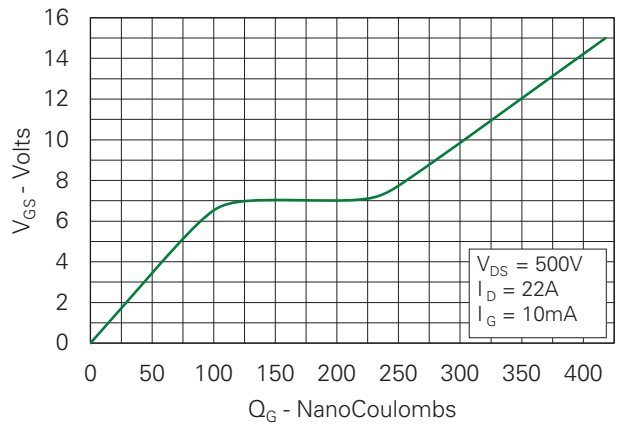

Fig. 11. Capacitance

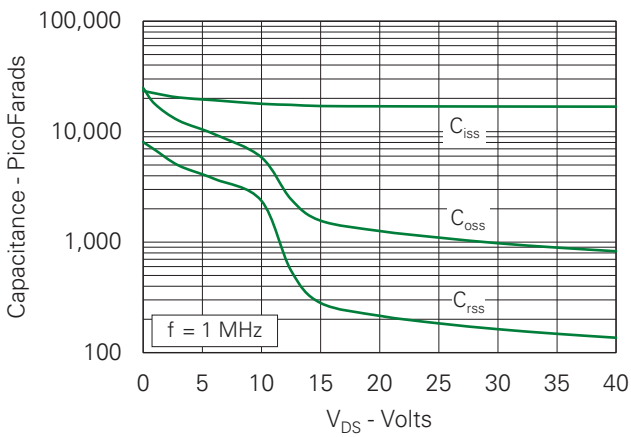
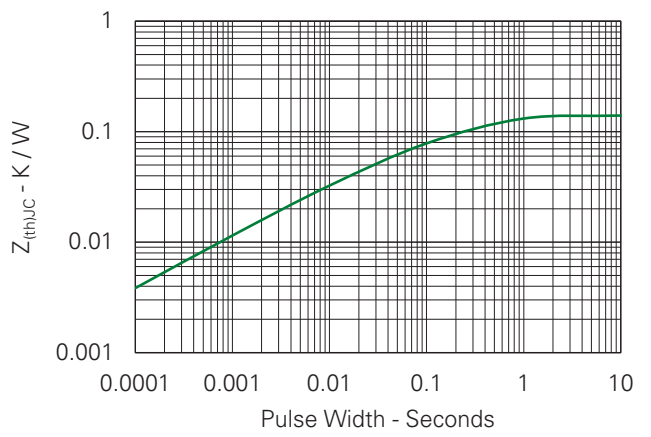
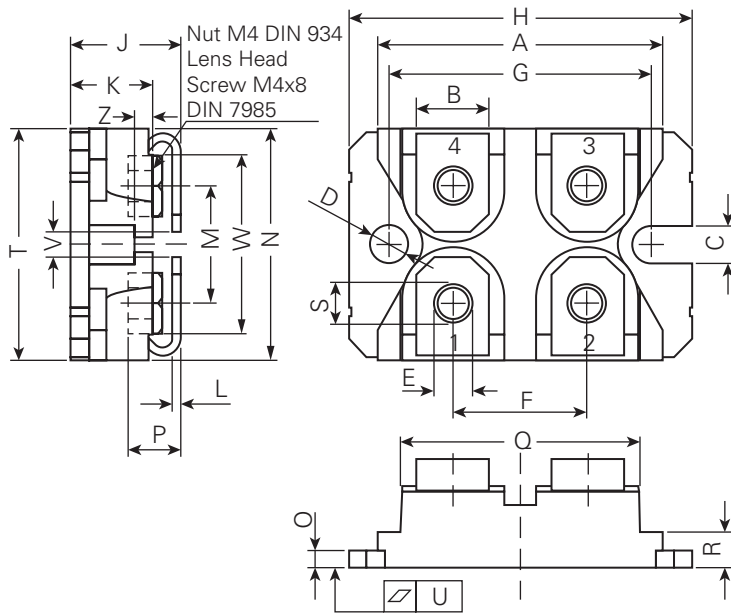

Fig. 12. Maximum Transient Thermal Impedance



## Part Outline Drawing (SOT-227B)



Symbol	Inches		Millimeters	
	Min.	Max.	Min.	Max.
A	1.240	1.255	31.50	31.88
B	0.307	0.323	7.80	8.20
C	0.161	0.169	4.09	4.29
D	0.161	0.169	4.09	4.29
E	0.161	0.169	4.09	4.29
F	0.587	0.595	14.91	15.11
G	1.186	1.193	30.12	30.30
H	1.488	1.505	37.80	38.23
J	0.460	0.481	11.68	12.22
K	0.351	0.378	8.92	9.60
L	0.029	0.033	0.74	0.84
M	0.492	0.516	12.50	13.10
N	0.990	1.001	25.15	25.42
O	0.077	0.084	1.95	2.13
P	0.195	0.244	4.95	6.20
Q	1.045	1.059	26.54	26.90
R	0.155	0.167	3.94	4.42
S	0.179	0.191	4.55	4.85
T	0.968	0.994	24.59	25.25
U	-0.002	0.004	-0.05	0.10
V	0.126	0.217	3.20	5.50
W	0.780	0.830	19.81	21.08
Z	.098	0.106	2.50	2.70

## Disclaimer Notice

Information furnished is believed to be accurate and reliable. However, users should independently evaluate the suitability of and test each product selected for their own applications. Littelfuse products are not designed for, and may not be used in, all applications. Read complete Disclaimer Notice at <http://www.littelfuse.com/disclaimer-electronics>.



Part of:

