



Description

ICONICRF's ICP1240 is a 3 stage MMIC power amplifier in bare die form, fabricated using GaN on SiC technology. ICP1240 operates from 6-18GHz with 41 dBm output power, >18% PAE and 23dB typical small signal gain. ICP1240 is well suited to a variety of commercial, aerospace and defense applications.

Features

- Frequency Range: 6-18GHz
- Pout: 41 dBm @ 24dBm Pin
- Typical PAE: 22 %
- Small Signal Gain: 23dB
- Bias: $V_D=20V$ $I_{DQ}=1500mA$, Typical $V_G=-1.6V$
- Technology: GaN on SiC
- Lead-free and RoHS compliant
- Die Size = 5.15 mm x 3.15 mm

Applications

- Test and Measurement
- Aerospace & Defense

Functional Block Diagram

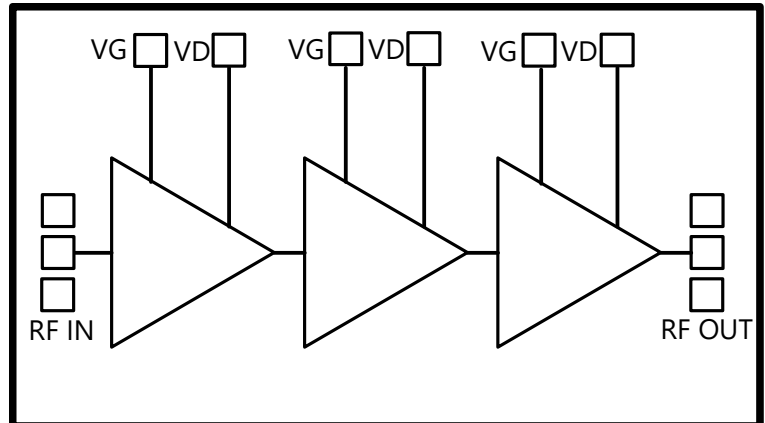

Electrical Specifications | Test Conditions unless otherwise stated | $V_D=24V$, $I_D=280mA$, $TA=25^\circ C$, CW

Parameter	Conditions	Min	Typ	Max	Units
Frequency		6		18	GHz
Output Power @ P_{sat}	Pin=24dBm		41		dBm
PAE @ P_{sat}	Pin=24dBm		22		%
Small Signal Gain			23		dB
Input Return Loss			15		dB
Output Return Loss			7		dB



Absolute Maximum Ratings

Parameter	Absolute Maximum
Drain Voltage (V_D)	30.0V
Gate Voltage Range (V_G)	-5 to 0V
Gate Current (I_G)	14mA
Drain Current (CW) $T_A=25^\circ\text{C}$	6.0A
Power Dissipation (CW) $T_A=25^\circ\text{C}$ Power Dissipation (CW) $T_A=85^\circ\text{C}$	140W 110W
CW Input Power 50ohm, $T_A=25^\circ\text{C}$	+29dBm
Channel Temperature	275°C
Storage Temperature	-65°C to +150°C
Input Power VSWR (2:1), $V_D=20\text{V}$, $I_{DQ}=280\text{mA}$ $V_D=24\text{V}$, $I_{DQ}=280\text{mA}$	27dBm
Eutectic Die Attach Temperature (30s)	320°C

Exceeding any one or combination of these limits may cause permanent damage to this device. ICONIC RF does not recommend sustained operation near these survivability limits.

Thermal and Reliability

Parameter	Value
Thermal Resistance	1.71°C/W

Notes

- Assumes silver sintered epoxy attach (15um thick) mounted on CuMo carrier.
- Base temperature is assumed at the top of the CuMo carrier
- Thermal resistance calculated using IR measurement of the channel temperature.

Ordering Information

Part No.	Description
ICP1240-1-110I	Bare die in Gel-Pack trays
ICP1240-1-501U	Evaluation Board with SMA connectors

Performance Data

Typical Small Signal Data | Test conditions unless otherwise stated $V_D=24\text{V}$, $I_{DQ}=280\text{mA}$, $T_A=25^\circ\text{C}$, CW

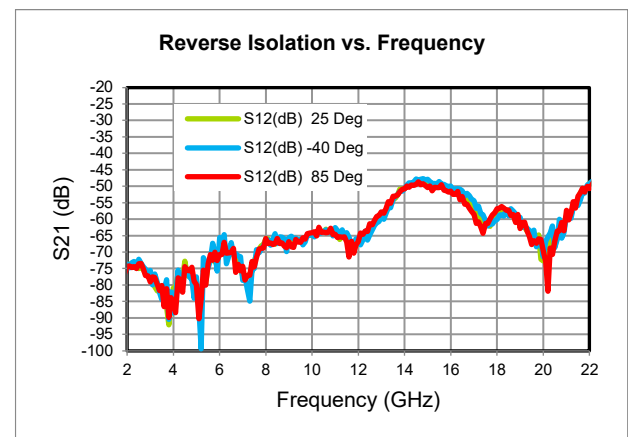
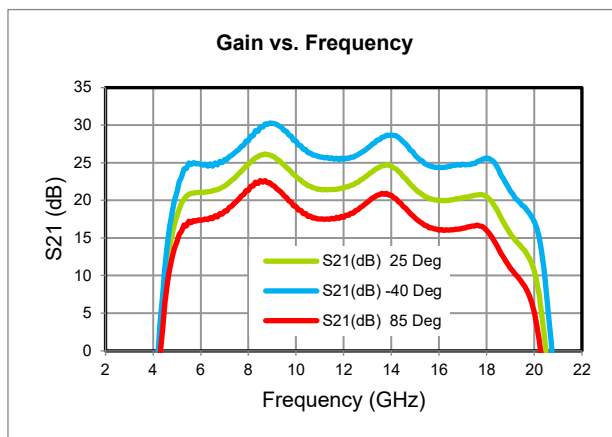
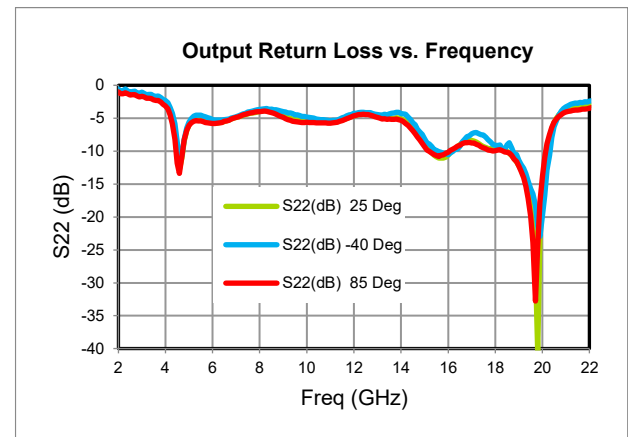
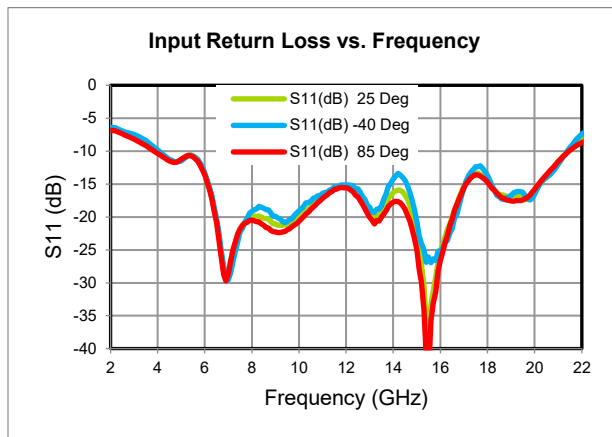



Typical Large Signal Data, CW | Test conditions unless otherwise stated $V_D=24V$, $I_{DQ}=280mA$, $T_A=25^\circ C$, CW

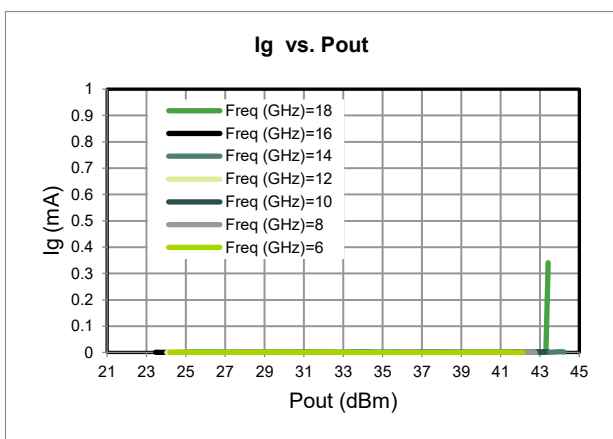
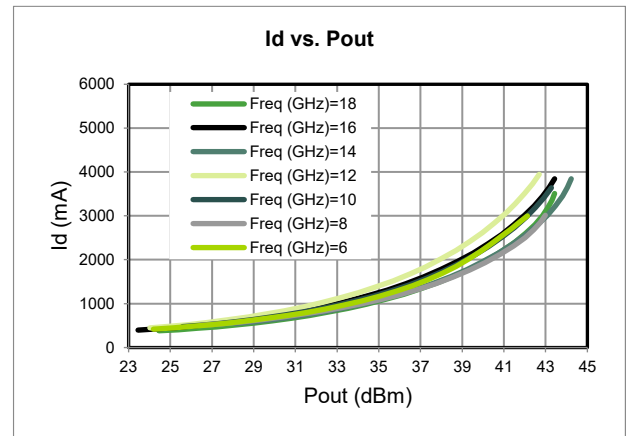
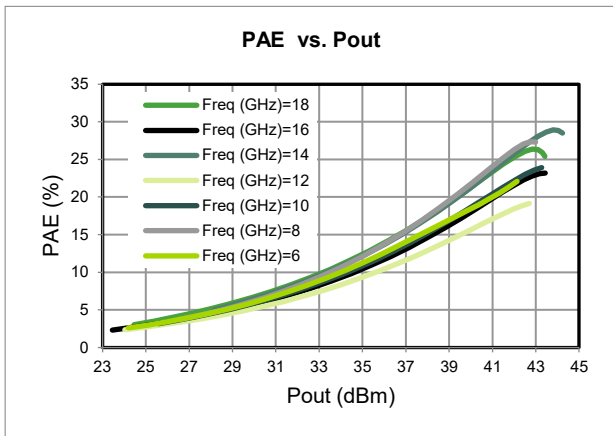
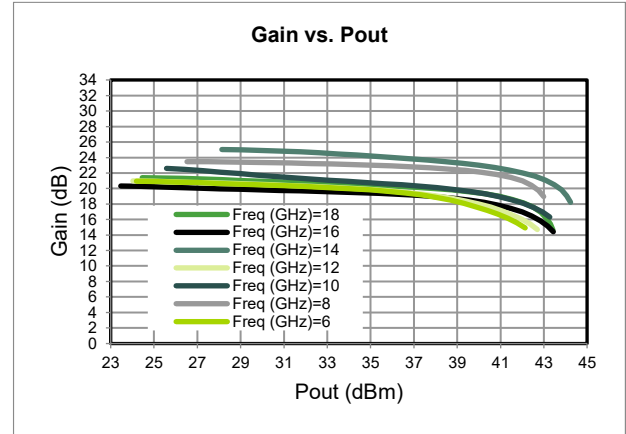
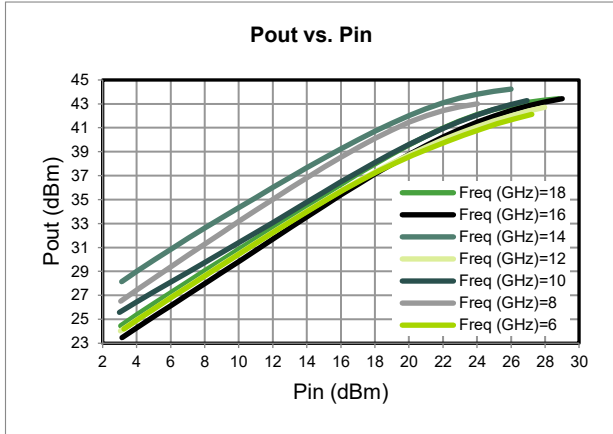



Typical Large Signal Data, CW | Test conditions unless otherwise stated $V_D=18V, 20V, 24V$, $I_{DQ}=280mA$, $T_A=25^\circ C$, CW

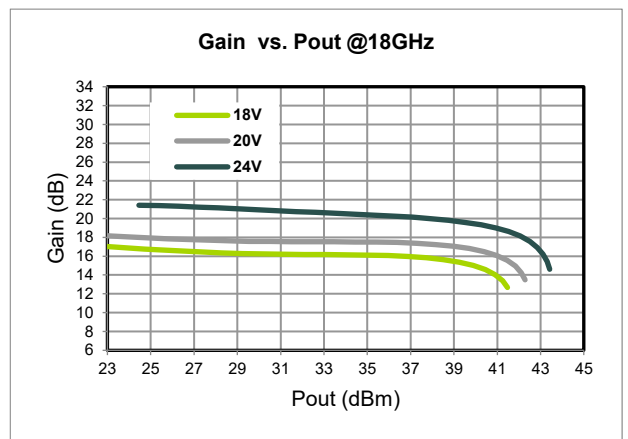
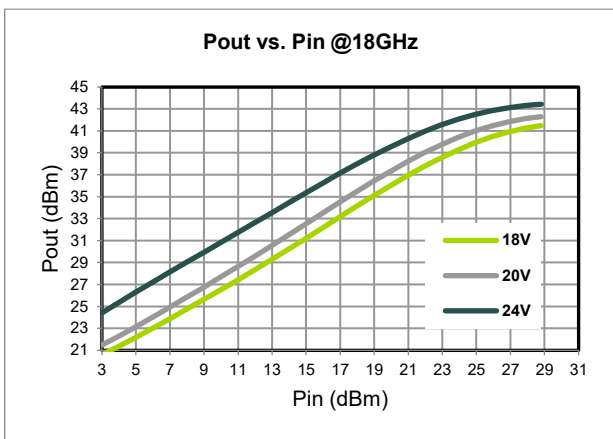
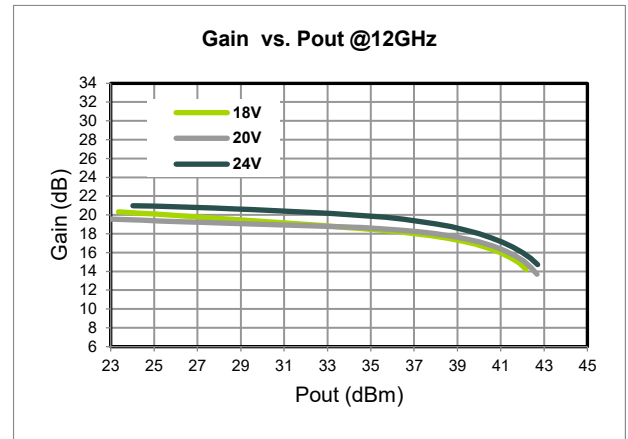
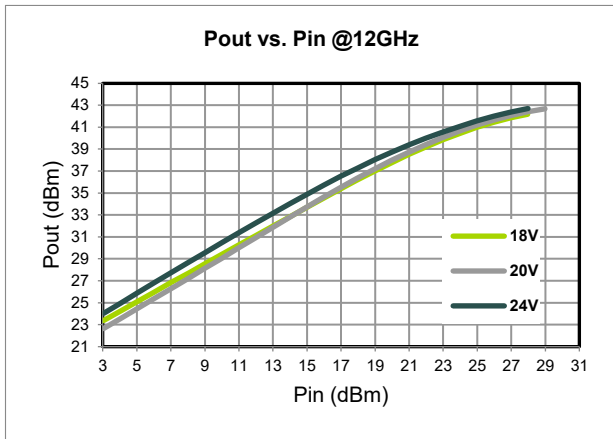
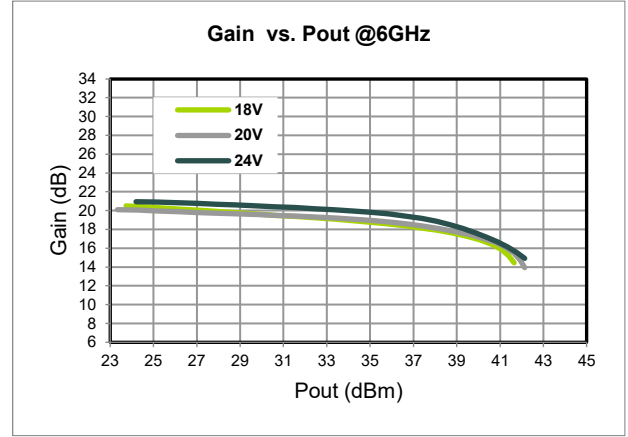
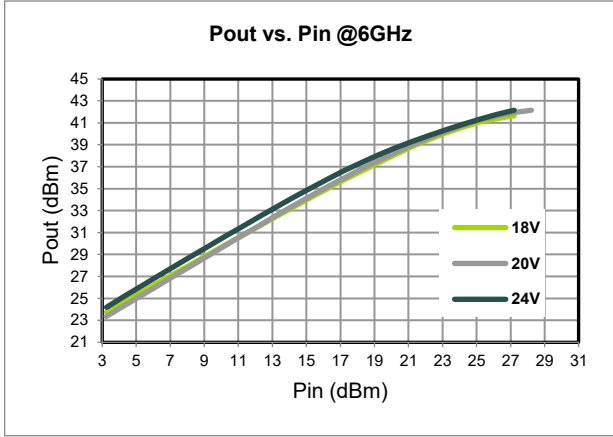



Typical Large Signal Data, CW | Test conditions unless otherwise stated $V_D=18V, 20V, 24V$, $I_{DQ}=280mA$, $T_A=25^\circ C$, CW

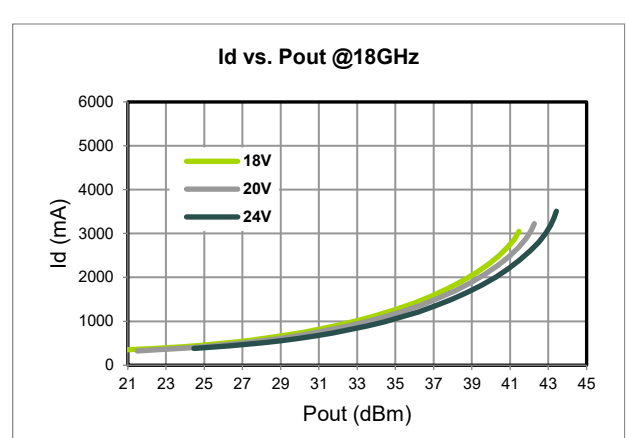
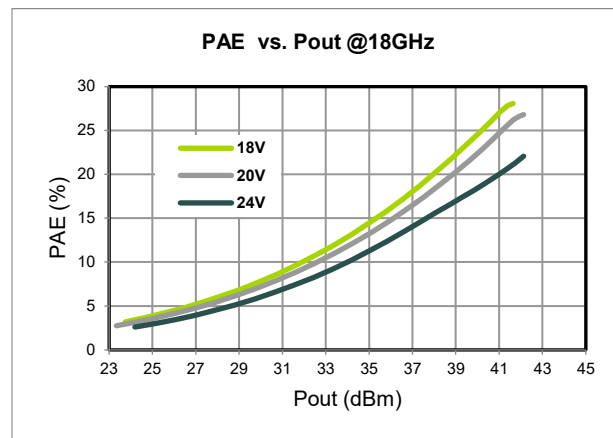
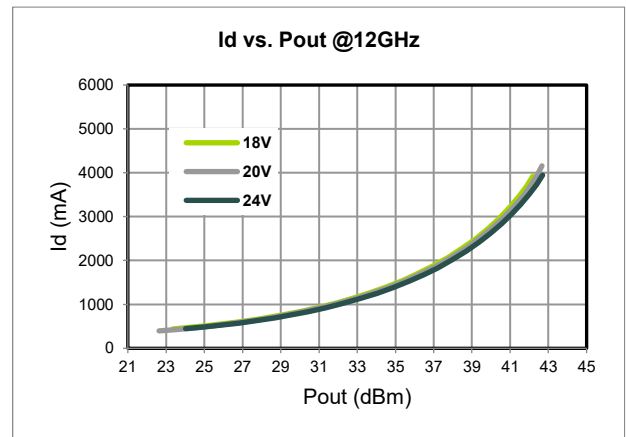
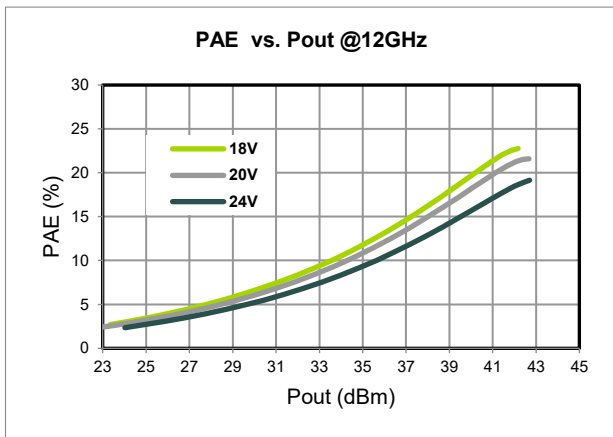
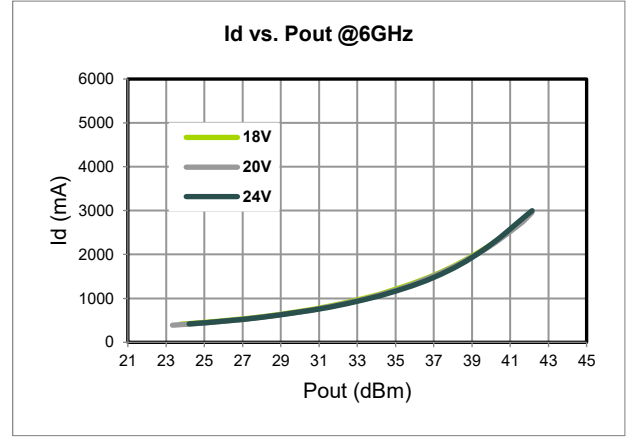
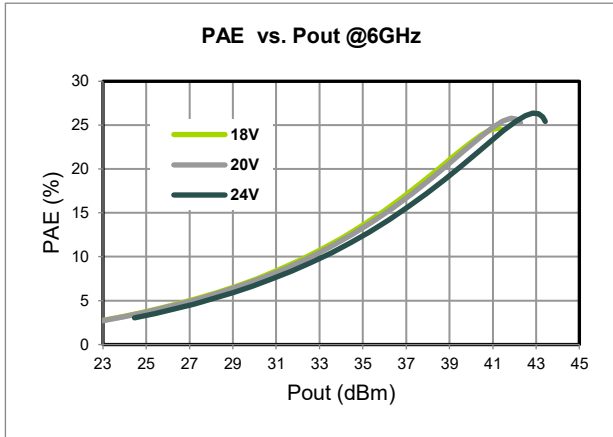



Typical Large Signal Data, CW | Test conditions unless otherwise stated $V_D=18V, 20V, 24V$, $I_{DQ}=280mA$, $T_A=25^\circ C$, CW

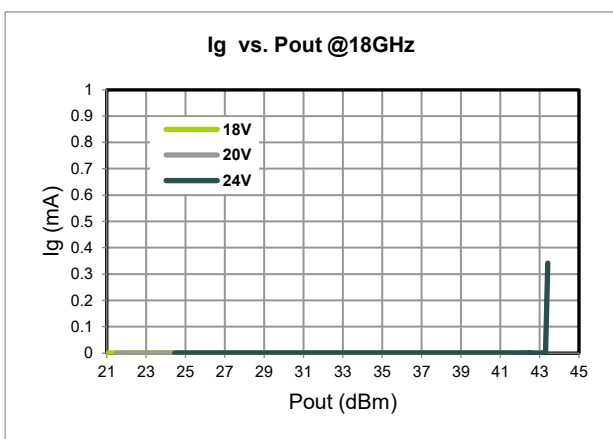
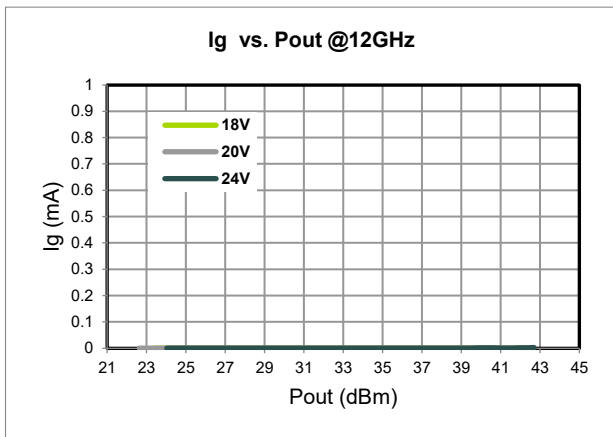
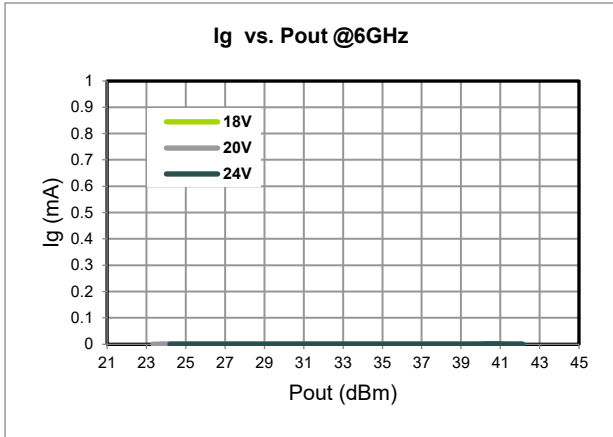



Typical Large Signal Data, CW | Test conditions unless otherwise stated $V_D=24V$, $I_{DQ}=280mA$, $T_A=25^\circ C$, CW

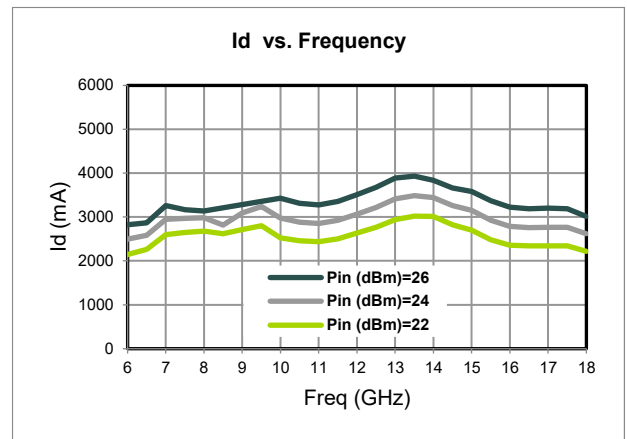
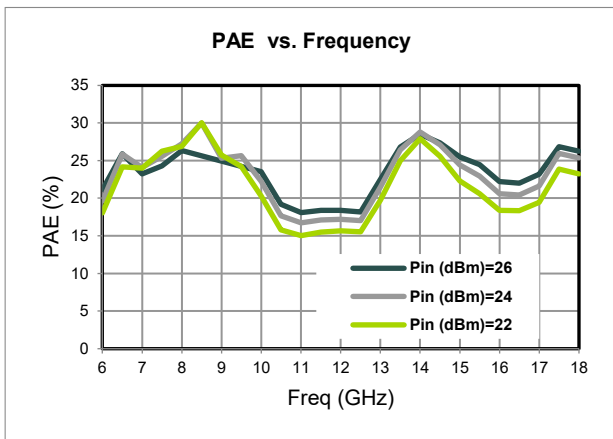
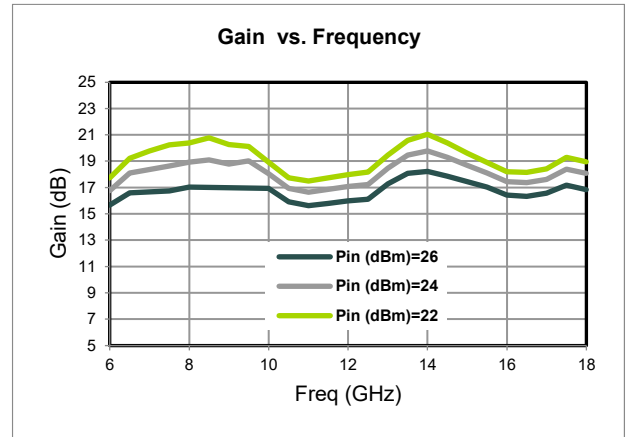
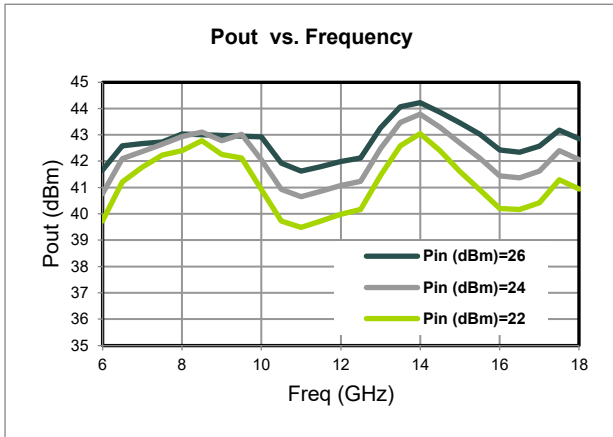



Typical Large Signal Data, CW | Test conditions unless otherwise stated $V_D = 24V$, $I_{DQ} = 280mA$, $T_A = 25^\circ C$, CW

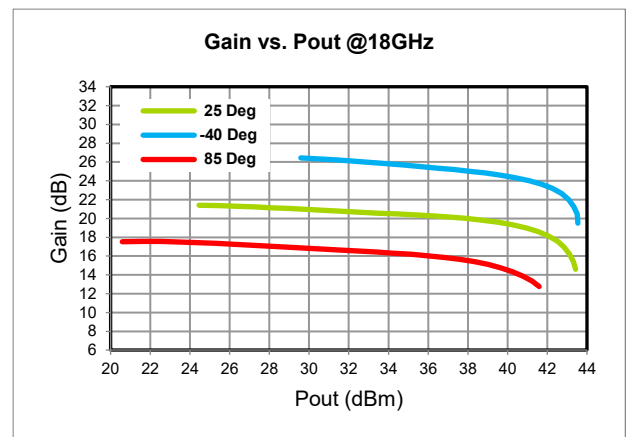
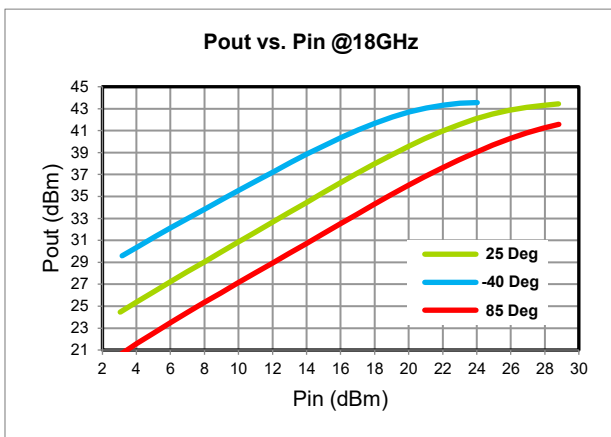
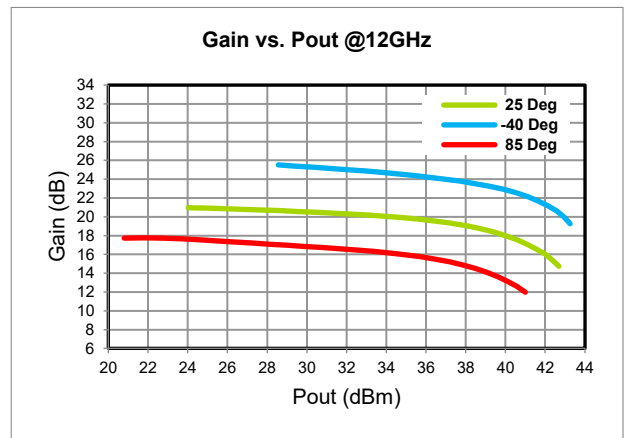
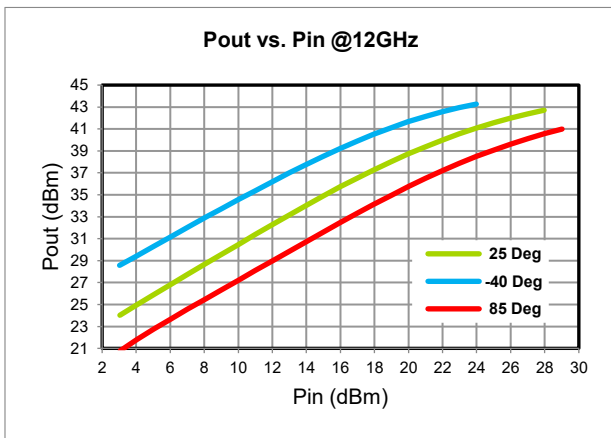
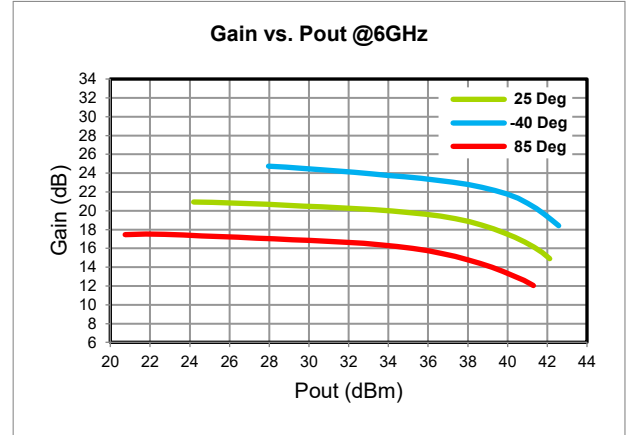
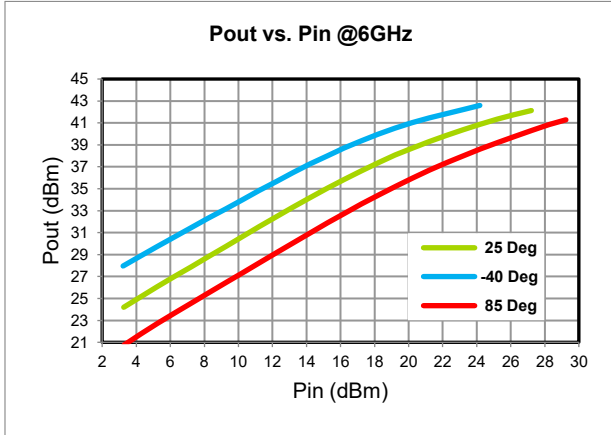



Typical Large Signal Data, CW | Test conditions unless otherwise stated $V_D = 24V$, $I_{DQ} = 280mA$, $T_A = 25^\circ C$, CW

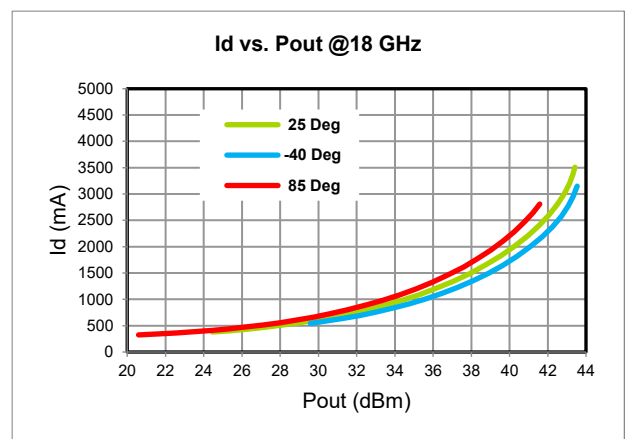
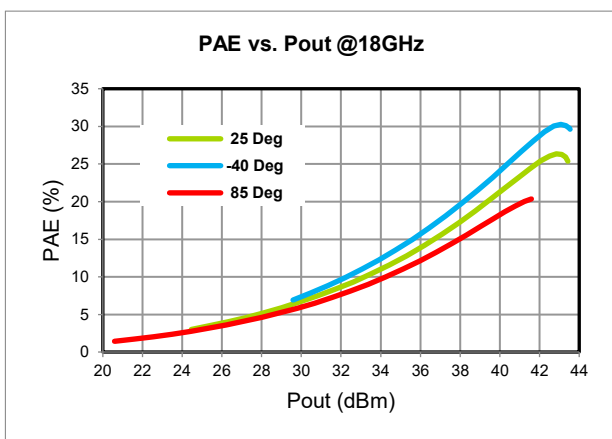
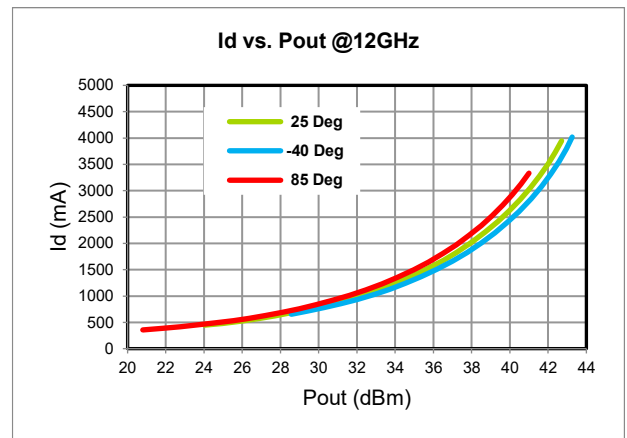
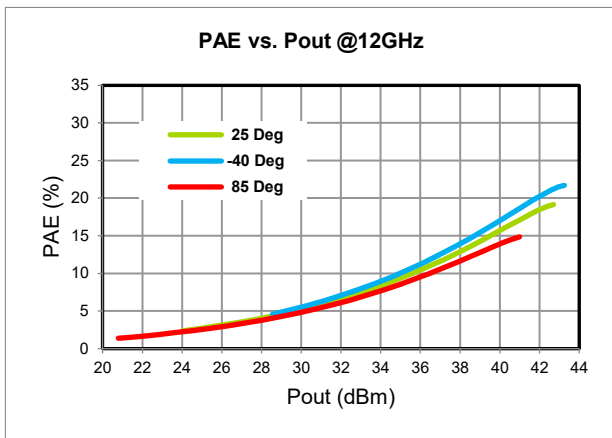
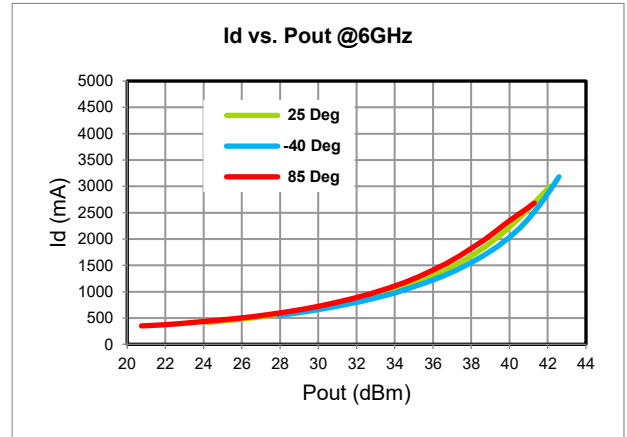
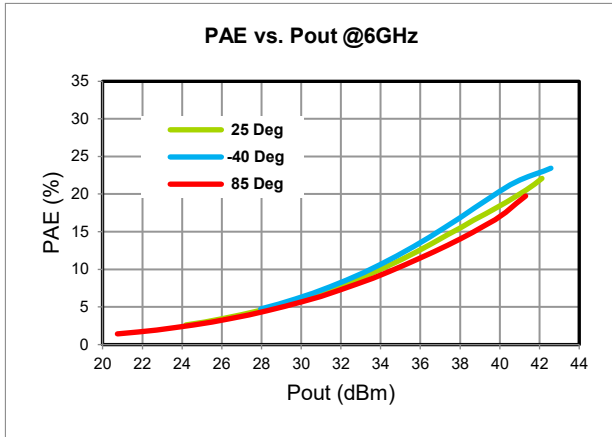

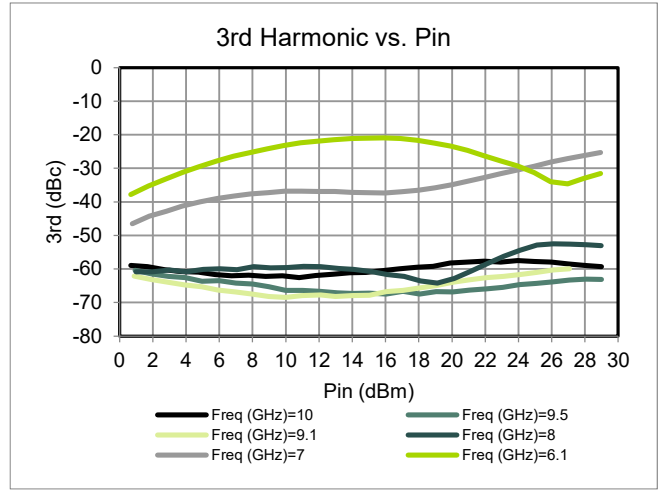
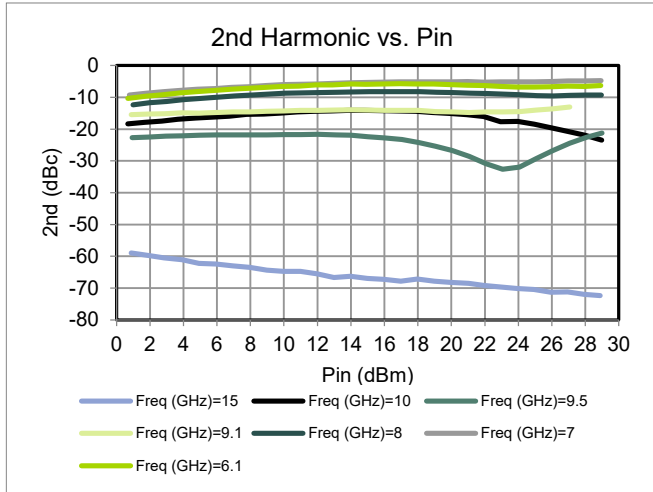

Typical Large Signal Data, 2nd, 3rd Harmonic

 Test conditions unless otherwise stated $V_D = 24V$, $I_{DQ} = 280mA$, $T_A = 25^\circ C$ 

Typical Linearity Data

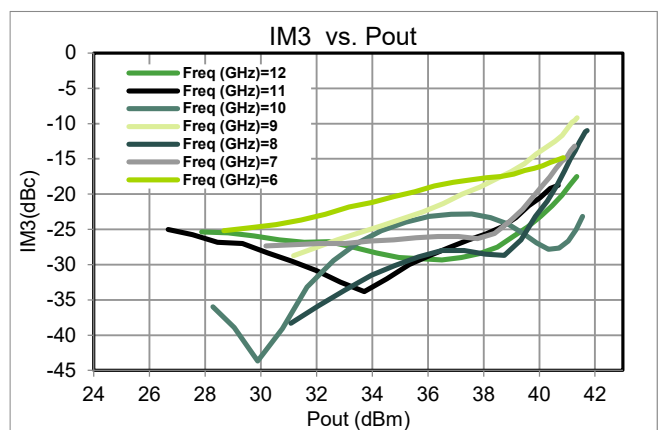
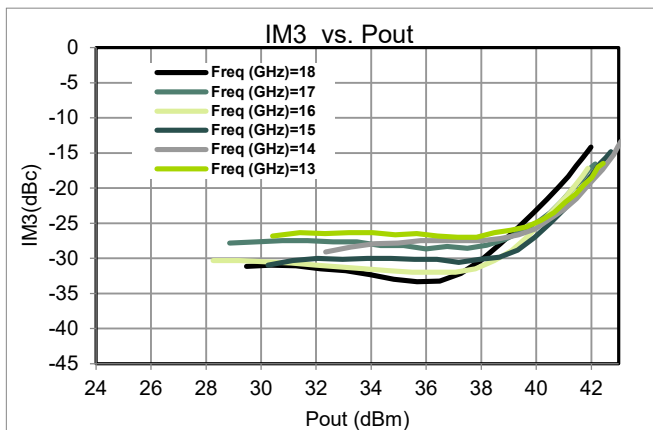
 Test conditions unless otherwise stated $V_D = 24V$, $I_{DQ} = 280mA$, $T_A = 25^\circ C$, Tone Spacing 10MHz



Mechanical Drawing

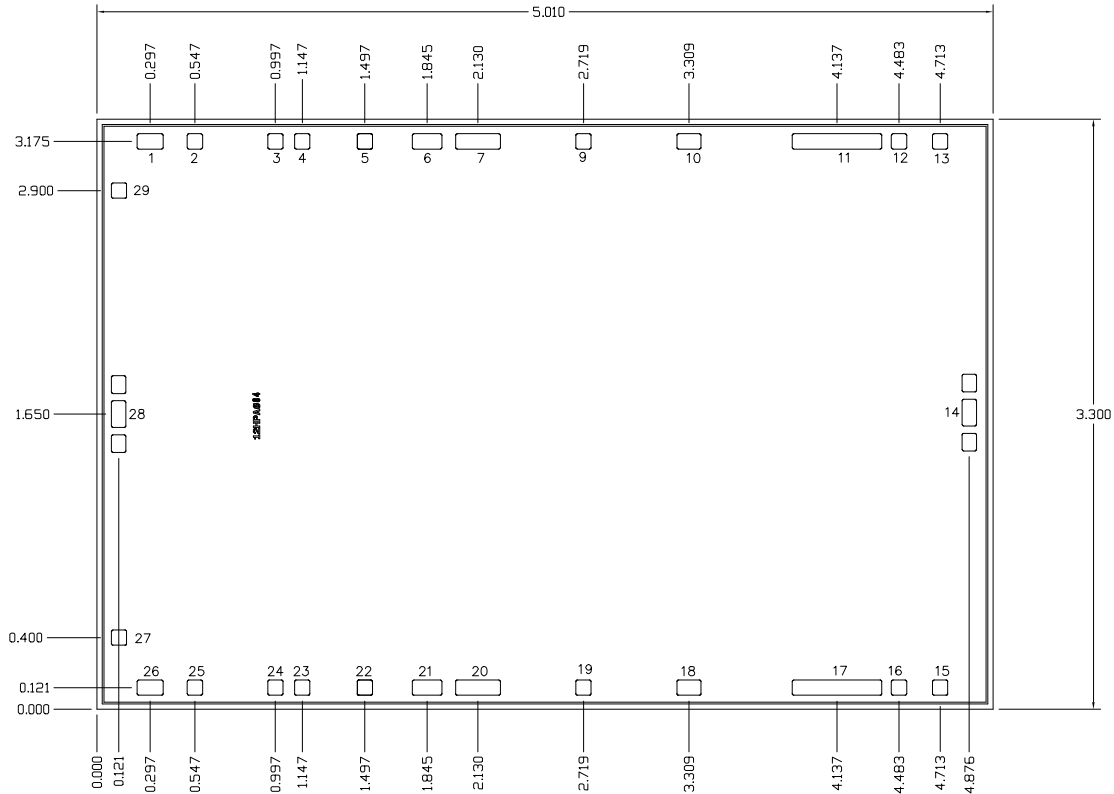

Units: mm

Thickness: 100um

Backside is RF and DC ground

Pad No	Pad Size	Function	Description
1,10,18,26	145x85	Ground	Ground
3,12,13,15,16,24	85x85	Ground	Ground
2,25	85x85	VG1	First stage north gate bias, decoupling and bypass caps required, must be biased from both sides
6,21	165x85	VD1	First stage north drain voltage, decoupling and bypass caps required, must be biased from both sides
4,23	85x85	VG2	Second stage gate bias, decoupling and bypass caps required, must be biased from both sides
7,20	250x85	VD2	Second stage drain voltage, decoupling and bypass caps required, must be biased from both sides
5,9,19,22	85x85	VG3	Third stage gate bias, decoupling and bypass caps required, must be biased from both sides
11,17	500x85	VD3	Third stage drain voltage, decoupling and bypass caps required, must be biased from both sides
14	80x150	RFOUT	50 ohm RF output, DC blocked, pad is DC grounded
28	80x150	RFIN	50 ohm RF input, DC blocked



Application Circuit

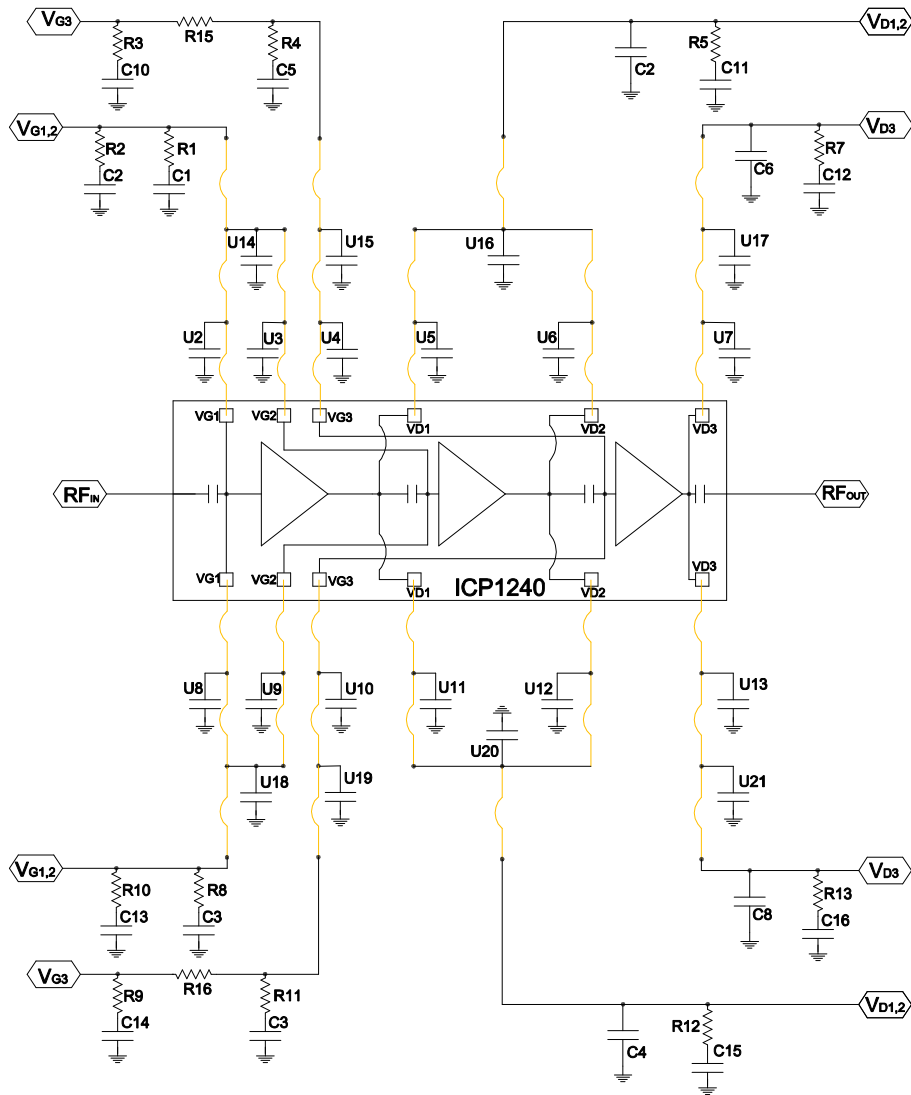

Bill of Materials

Assembly Reference	Value	Description
U1		6-18GHz MMIC
U2-U13	100pF	Johanson 100pF SLC Capacitor
U14-U21	10nF	10nF SLC Capacitor
C1,C3,C5,C7	100nF	100nF Capacitor,10%,50V,0402
C2,C4,C6,C8	10nF	10nF Capacitor,10%,50V,0402
C9-C16	10uF	10uF Capacitor,10%,50V,1206
R1-R5,R7-R13	5.1Ohms	5.1 Ohms Resistor,0402
R6,R14	0 Ohm	0 Ohm Resistor,0402
R15,R16	82Ohm	82Ohm Resistor



Assembly Drawing

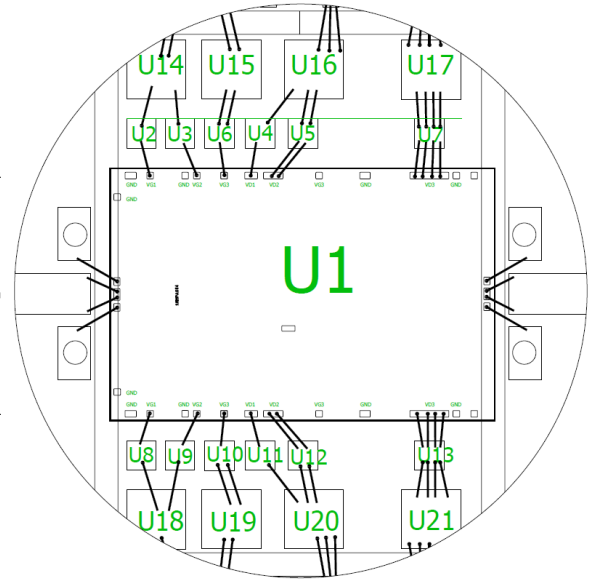
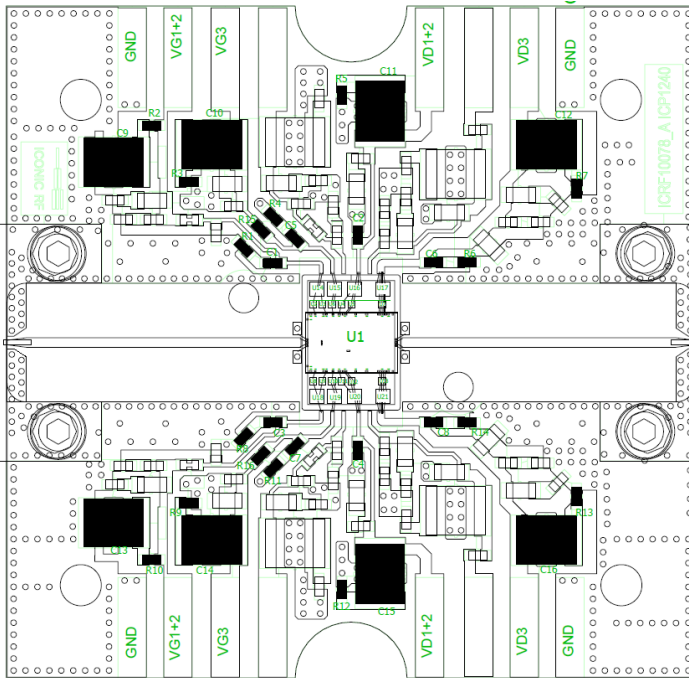

PCB Fabrication

PCB Construction	Material	Dimensions	Key Features	Dimensions
METAL1_TOP	Cu + ENIG	1oz Cu plated Electroless Nickel 3-5µm	VIA Drill	0.3mm
DIELECTRIC	RO4350C	10mils (254µm)	VIA Plating Thickness	50-70um
METAL2_BOTTOM	Cu + ENIG	1oz Cu plated Electroless Nickel 3-5µm	50 Ohm Line Width	525um

Assembly Guidance

Optimum RF power performance achieved by minimizing output RF bond wire length.

Interconnect assembly Notes

- Ball Bonding is preferred technique
- Force, time and ultrasonic parameters are critical.
- Aluminum wire bonding is not recommended.
- Bond Wire diameter of 1mil is recommended.

Die attach of component using adhesive

- Vacuum collets are preferred method of pickup.
- Pickup method must consider the avoidance of die air bridges.
- Die suitable for Eutectic and Epoxy die attach.
- Where Epoxy is used, high thermal conductivity Silver Sintered Epoxy is recommended:-
 - Namics H9889-1
 - Kyocera CT2700R7S

Die attach using Eutectic

- Flux-less gold-tin (AuSn) (80% Au, 20% Sn with a melting point of 280°C) preform is preferred between the die and attached surface.
- Recommended preform should be approximately 0.0012" thick.
- Die bonder using heated collet with a temperature of 310°C and die scrubbing should be used to ensure wetting and prevent formation of voids.
- Exposure to extreme temperature should be kept to a minimum.
- The optimum die attach environment is nitrogen atmosphere.

Reflow Process

- Maximum temperature 320°C for 30 seconds.
- Material matching for coefficient of thermal expansion is crucial for long-term reliability



Assembly Guidance continued.

For optimum RF and thermal performance IconicRF recommends the die assembly base plate is adequately bolted to an forced air heat sink using a thermal graphite interface pad (Graphite Interface Material GCSP-017-G 170 μ m thick) for optimal heat transfer.

There are many variables of the second level assembly between the die base plate and heat sink that IconicRF are unable to control and the following guidance is provided as information only. Fixing bolts should be provided as close to the die as possible to ensure a optimum pressure between the base plate and the heat sink.

The bolting screws used to attach the PCB assembly to the heat sink must include washers and be tightened with a suitable tightening pattern to ensure a uniform pressure. It is advised all surfaces be cleaned and be free of grease and dust prior to fully aligning the assembly with all screws located and tightened to finger tight. Further torquing of the screws must be achieved in multiple phases using a star shaped pattern to a recommended torque of 2.5N/m.

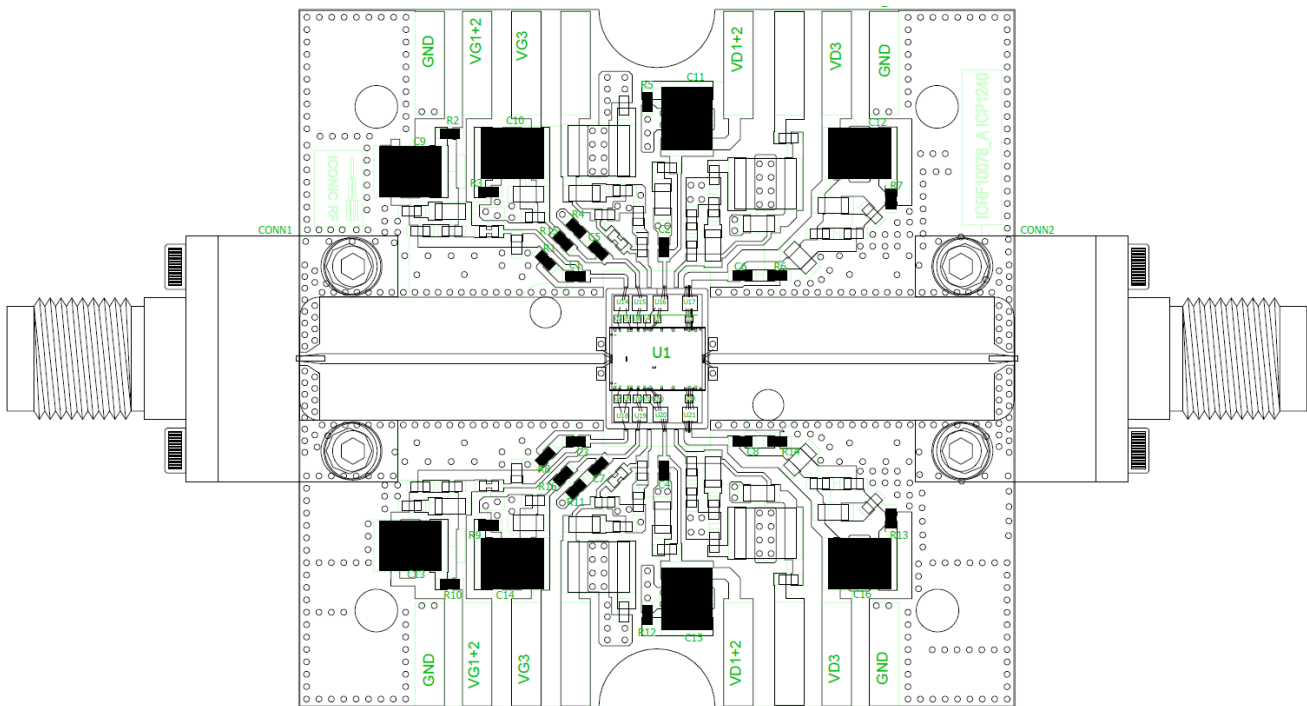

Bias-Up Procedure

1. Set $V_G = -5V$
2. Set V_D to 20-24V
3. Adjust V_G positive until I_D quiescent is 280mA
4. Limit I_D to 4.5A
5. Apply RF Signal

Bias-down Procedure

1. Turn off RF
2. Turn off V_D , allow drain capacitor to discharge
3. Turn off V_G .

Handling Procedures

Please observe the following precautions to avoid damage:

Static Sensitivity

Integrated Circuits are sensitive to electrostatic discharge (ESD) and can be damaged by static electricity. Proper ESD control techniques should be used when handling these devices. Class 1A HBM (250-500V) ESD Classification is anticipated.



The Microchip Website

Microchip provides online support via our website at www.microchip.com/. This website is used to make files and information easily available to customers. Some of the content available includes:

- Product Support – Data sheets and errata, application notes and sample programs, design resources, user's guides and hardware support documents, latest software releases and archived software
- General Technical Support – Frequently Asked Questions (FAQs), technical support requests, online discussion groups, Microchip design partner program member listing
- Business of Microchip – Product selector and ordering guides, latest Microchip press releases, listing of seminars and events, listings of Microchip sales offices, distributors and factory representatives

Product Change Notification Service

Microchip's product change notification service helps keep customers current on Microchip products. Subscribers will receive email notification whenever there are changes, updates, revisions or errata related to a specified product family or development tool of interest.

To register, go to www.microchip.com/pcn and follow the registration instructions.

Customer Support

Users of Microchip products can receive assistance through several channels:

- Distributor or Representative
- Local Sales Office
- Embedded Solutions Engineer (ESE)
- Technical Support

Customers should contact their distributor, representative or ESE for support. Local sales offices are also available to help customers. A listing of sales offices and locations is included in this document.

Technical support is available through the website at: www.microchip.com/support

Microchip Devices Code Protection Feature

Note the following details of the code protection feature on Microchip products:

Microchip products meet the specifications contained in their particular Microchip Data Sheet.

- Microchip believes that its family of products is secure when used in the intended manner, within operating specifications, and under normal conditions.
- Microchip values and aggressively protects its intellectual property rights. Attempts to breach the code protection features of Microchip product is strictly prohibited and may violate the Digital Millennium Copyright Act.
- Neither Microchip nor any other semiconductor manufacturer can guarantee the security of its code. Code protection does not mean that we are guaranteeing the product is "unbreakable". Code protection is constantly evolving. Microchip is committed to continuously improving the code protection features of our products.

Legal Notice

This publication and the information herein may be used only with Microchip products, including to design, test, and integrate Microchip products with your application. Use of this information in any other manner violates these terms. Information regarding device applications is provided only for your convenience and may be superseded by updates. It is your responsibility to ensure that your application meets with your specifications. Contact your local Microchip sales office for additional support or, obtain additional support at www.microchip.com/en-us/support/design-help/client-support-services.



THIS INFORMATION IS PROVIDED BY MICROCHIP "AS IS". MICROCHIP MAKES NO REPRESENTATIONS OR WARRANTIES OF ANY KIND WHETHER EXPRESS OR IMPLIED, WRITTEN OR ORAL, STATUTORY OR OTHERWISE, RELATED TO THE INFORMATION INCLUDING BUT NOT LIMITED TO ANY IMPLIED WARRANTIES OF NON-INFRINGEMENT, MERCHANTABILITY, AND FITNESS FOR A PARTICULAR PURPOSE, OR WARRANTIES RELATED TO ITS CONDITION, QUALITY, OR PERFORMANCE.

IN NO EVENT WILL MICROCHIP BE LIABLE FOR ANY INDIRECT, SPECIAL, PUNITIVE, INCIDENTAL, OR CONSEQUENTIAL LOSS, DAMAGE, COST, OR EXPENSE OF ANY KIND WHATSOEVER RELATED TO THE INFORMATION OR ITS USE, HOWEVER CAUSED, EVEN IF MICROCHIP HAS BEEN ADVISED OF THE POSSIBILITY OR THE DAMAGES ARE FORESEEABLE. TO THE FULLEST EXTENT ALLOWED BY LAW, MICROCHIP'S TOTAL LIABILITY ON ALL CLAIMS IN ANY WAY RELATED TO THE INFORMATION OR ITS USE WILL NOT EXCEED THE AMOUNT OF FEES, IF ANY, THAT YOU HAVE PAID DIRECTLY TO MICROCHIP FOR THE INFORMATION.

Use of Microchip devices in life support and/or safety applications is entirely at the buyer's risk, and the buyer agrees to defend, indemnify and hold harmless Microchip from any and all damages, claims, suits, or expenses resulting from such use. No licenses are conveyed, implicitly or otherwise, under any Microchip intellectual property rights unless otherwise stated.

Trademarks

The Microchip name and logo, the Microchip logo, Adaptec, AVR, AVR logo, AVR Freaks, BesTime, BitCloud, CryptoMemory, CryptoRF, dsPIC, flexPWR, HELDO, IGLOO, JukeBlox, KeeLoq, Kleer, LANCheck, LinkMD, maXStylus, maXTouch, MedialB, megaAVR, Microsemi, Microsemi logo, MOST, MOST logo, MPLAB, OptoLyzer, PIC, picoPower, PICSTART, PIC32 logo, PolarFire, Prochip Designer, QTouch, SAM-BA, SenGenuity, SpyNIC, SST, SST Logo, SuperFlash, Symmetricom, SyncServer, Tachyon, TimeSource, tinyAVR, UNI/O, Vectron, and XMEGA are registered trademarks of Microchip Technology Incorporated in the U.S.A. and other countries.

AgileSwitch, APT, ClockWorks, The Embedded Control Solutions Company, EtherSynch, Flashtec, Hyper Speed Control, HyperLight Load, Libero, motorBench, mTouch, Powermite 3, Precision Edge, ProASIC, ProASIC Plus, ProASIC Plus logo, Quiet-Wire, SmartFusion, SyncWorld, Temux, TimeCesium, TimeHub, TimePictra, TimeProvider, TrueTime, and ZL are registered trademarks of Microchip Technology Incorporated in the U.S.A.

Adjacent Key Suppression, AKS, Analog-for-the-Digital Age, Any Capacitor, AnyIn, AnyOut, Augmented Switching, BlueSky, BodyCom, Clockstudio, CodeGuard, CryptoAuthentication, CryptoAutomotive, CryptoCompanion, CryptoController, dsPICDEM, dsPICDEM.net, Dynamic Average Matching, DAM, ECAN, Espresso T1S, EtherGREEN, GridTime, IdealBridge, In-Circuit Serial Programming, ICSP, INICnet, Intelligent Paralleling, IntellIMOS, Inter-Chip Connectivity, JitterBlocker, Knob-on-Display, KoD, maxCrypto, maxView, memBrain, Minda, MiWi, MPASM, MPF, MPLAB Certified logo, MPLIB, MPLINK, MultiTRAK, NetDetach, Omniscient Code Generation, PICDEM, PICDEM.net, PICkit, PICtail, PowerSmart, PureSilicon, QMatrix, REAL ICE, Ripple Blocker, RTAX, RTG4, SAM-ICE, Serial Quad I/O, simpleMAP, SimpliPHY, SmartBuffer, SmartHLS, SMART-I.S., storClad, SQI, SuperSwitcher, SuperSwitcher II, Switchtec, SynchroPHY, Total Endurance, Trusted Time, TSHARC, USBCheck, VariSense, VectorBlox, VeriPHY, ViewSpan, WiperLock, XpressConnect, and ZENA are trademarks of Microchip Technology Incorporated in the U.S.A. and other countries.

SQTP is a service mark of Microchip Technology Incorporated in the U.S.A.

The Adaptec logo, Frequency on Demand, Silicon Storage Technology, and Symmcom are registered trademarks of Microchip Technology Inc. in other countries.

GestIC is a registered trademark of Microchip Technology Germany II GmbH & Co. KG, a subsidiary of Microchip

Technology Inc., in other countries.

All other trademarks mentioned herein are property of their respective companies.

© 2022, Microchip Technology Incorporated and its subsidiaries. All Rights Reserved.

ISBN: 978-1-5224-9497-3



Worldwide Sales and Service

AMERICAS	ASIA/PACIFIC	ASIA/PACIFIC	EUROPE
Corporate Office 2355 West Chandler Blvd. Chandler, AZ 85224-6199 Tel: 480-792-7200 Fax: 480-792-7277 Technical Support: www.microchip.com/support Web Address: www.microchip.com	Australia - Sydney Tel: 61-2-9868-6733 China - Beijing Tel: 86-10-8569-7000 China - Chengdu Tel: 86-28-8665-5511 China - Chongqing Tel: 86-23-8980-9588 China - Dongguan Tel: 86-769-8702-9880 China - Guangzhou Tel: 86-20-8755-8029 China - Hangzhou Tel: 86-571-8792-8115 China - Hong Kong SAR Tel: 852-2943-5100 China - Nanjing Tel: 86-25-8473-2460 China - Qingdao Tel: 86-532-8502-7355 China - Shanghai Tel: 86-21-3326-8000 China - Shenyang Tel: 86-24-2334-2829 China - Shenzhen Tel: 86-755-8864-2200 China - Suzhou Tel: 86-186-6233-1526 China - Wuhan Tel: 86-27-5980-5300 China - Xian Tel: 86-29-8833-7252 China - Xiamen Tel: 86-592-2388138 China - Zhuhai Tel: 86-756-3210040	India - Bangalore Tel: 91-80-3090-4444 India - New Delhi Tel: 91-11-4160-8631 India - Pune Tel: 91-20-4121-0141 Japan - Osaka Tel: 81-6-6152-7160 Japan - Tokyo Tel: 81-3-6880-3770 Korea - Daegu Tel: 82-53-744-4301 Korea - Seoul Tel: 82-2-554-7200 Malaysia - Kuala Lumpur Tel: 60-3-7651-7906 Malaysia - Penang Tel: 60-4-227-8870 Philippines - Manila Tel: 63-2-634-9065 Singapore Tel: 65-6334-8870 Taiwan - Hsin Chu Tel: 886-3-577-8366 Taiwan - Kaohsiung Tel: 886-7-213-7830 Taiwan - Taipei Tel: 886-2-2508-8600 Thailand - Bangkok Tel: 66-2-694-1351 Vietnam - Ho Chi Minh Tel: 84-28-5448-2100	Austria - Wels Tel: 43-7242-2244-39 Fax: 43-7242-2244-393 Denmark - Copenhagen Tel: 45-4485-5910 Fax: 45-4485-2829 Finland - Espoo Tel: 358-9-4520-820 France - Paris Tel: 33-1-69-53-63-20 Fax: 33-1-69-30-90-79 Germany - Garching Tel: 49-8931-9700 Germany - Haan Tel: 49-2129-3766400 Germany - Heilbronn Tel: 49-7131-72400 Germany - Karlsruhe Tel: 49-721-625370 Germany - Munich Tel: 49-89-627-144-0 Fax: 49-89-627-144-44 Germany - Rosenheim Tel: 49-8031-354-560 Israel - Ra'anana Tel: 972-9-744-7705 Italy - Milan Tel: 39-0331-742611 Fax: 39-0331-466781 Italy - Padova Tel: 39-049-7625286 Netherlands - Drunen Tel: 31-416-690399 Fax: 31-416-690340 Norway - Trondheim Tel: 47-72884388 Poland - Warsaw Tel: 48-22-3325737 Romania - Bucharest Tel: 40-21-407-87-50 Spain - Madrid Tel: 34-91-708-08-90 Fax: 34-91-708-08-91 Sweden - Gothenberg Tel: 46-31-704-60-40 Sweden - Stockholm Tel: 46-8-5090-4654 UK - Wokingham Tel: 44-118-921-5800 Fax: 44-118-921-5820