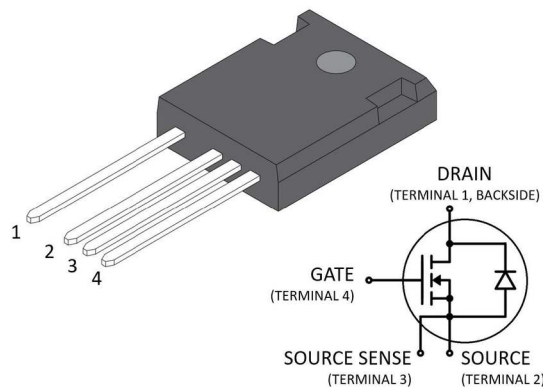

3300 V, 400 mΩ SiC N-Channel Power MOSFET

Product Overview

The silicon carbide (SiC) power MOSFET product line from Microsemi increases the performance over silicon MOSFET and silicon IGBT solutions while lowering the total cost of ownership for high-voltage applications. The MSC400SMA330B4 device is a 3300 V, 400 mΩ SiC MOSFET in a TO-247 4-lead package with a source sense.

**Features**

The following are key features of the MSC400SMA330B4 device:

- Low capacitances and low gate charge
- Fast switching speed due to low internal gate resistance (ESR)
- Stable operation at high junction temperature, $T_{J(max)} = 150\text{ }^{\circ}\text{C}$
- Fast and reliable body diode
- Superior avalanche ruggedness
- RoHS compliant

Benefits

The following are benefits of the MSC400SMA330B4 device:

- High efficiency to enable lighter, more compact system
- Simple to drive and easy to parallel
- Improved thermal capabilities and lower switching losses
- Eliminates the need for external freewheeling diode
- Lower system cost of ownership

Applications

The MSC400SMA330B4 device is designed for the following applications:

- PV inverter, converter, and industrial motor drives
- Smart grid transmission and distribution
- Induction heating and welding
- H/EV powertrain and EV charger
- Power supply and distribution

1. Device Specifications

This section shows the specifications of the MSC400SMA330B4 device.

1.1 Absolute Maximum Ratings

The following table shows the absolute maximum ratings of the MSC400SMA330B4 device.

Table 1-1. Absolute Maximum Ratings

Symbol	Parameter	Ratings	Unit
V_{DSS}	Drain source voltage	3300	V
I_D	Continuous drain current at $T_C = 25\text{ }^\circ\text{C}$	11	A
	Continuous drain current at $T_C = 100\text{ }^\circ\text{C}$	7	
I_{DM}	Pulsed drain current ¹	27	
V_{GS}	Gate-source voltage	23 to -10	V
P_D	Total power dissipation at $T_C = 25\text{ }^\circ\text{C}$	131	W
	Linear derating factor	1.05	W/ $^\circ\text{C}$

Note:

1. Repetitive rating: pulse width and case temperature limited by maximum junction temperature.

The following table shows the thermal and mechanical characteristics of the MSC400SMA330B4 device.

Table 1-2. Thermal and Mechanical Characteristics

Symbol	Characteristic/Test Conditions	Min	Typ	Max	Unit
$R_{\theta JC}$	Junction-to-case thermal resistance		0.64	0.96	$^\circ\text{C}/\text{W}$
T_J	Operating junction temperature	-55		150	$^\circ\text{C}$
T_{STG}	Storage temperature	-55		150	$^\circ\text{C}$
T_L	Soldering temperature for 10 seconds (1.6 mm from case)			300	$^\circ\text{C}$
	Mounting torque, 6-32 or M3 screw			10	lbf-in
				1.1	N-m
W_t	Package weight		0.22		oz
			6.2		g

1.2 Electrical Performance

The following table shows the static characteristics of the MSC400SMA330B4 device. $T_J = 25\text{ }^\circ\text{C}$ unless otherwise specified.

Table 1-3. Static Characteristics

Symbol	Characteristic	Test Conditions	Min	Typ	Max	Unit
$V_{(BR)DSS}$	Drain-source breakdown voltage	$V_{GS} = 0\text{ V}, I_D = 100\text{ }\mu\text{A}$	3300			V
$R_{DS(on)}$	Drain-source on resistance ¹	$V_{GS} = 20\text{ V}, I_D = 5\text{ A}$		416	520	m Ω

MSC400SMA330B4

Device Specifications

.....continued

Symbol	Characteristic	Test Conditions	Min	Typ	Max	Unit
$V_{GS(th)}$	Gate-source threshold voltage	$V_{GS} = V_{DS}$, $I_D = 1$ mA	1.9	2.97		V
I_{DSS}	Zero gate voltage drain current	$V_{DS} = 3300$ V, $V_{GS} = 0$ V			100	μ A
		$V_{DS} = 3300$ V, $V_{GS} = 0$ V, $T_J = 125$ °C			500	
I_{GSS}	Gate-source leakage current	$V_{GS} = 20$ V/–10 V			± 100	nA

Note:

1. Pulse test: pulse width < 380 μ s, duty cycle < 2%.

The following table shows the dynamic characteristics of the MSC400SMA330B4 device. $T_J = 25$ °C unless otherwise specified.

Table 1-4. Dynamic Characteristics

Symbol	Characteristic	Test Conditions	Min	Typ	Max	Unit
C_{iss}	Input capacitance	$V_{GS} = 0$ V $V_{DD} = 2400$ V		579		pF
C_{rSS}	Reverse transfer capacitance	$V_{AC} = 25$ mV		2		
C_{oss}	Output capacitance	$f = 200$ kHz		18		
Q_g	Total gate charge	$V_{DD} = 2600$ V $V_{GS} = -5$ V/20 V		37		nC
Q_{gs}	Gate-source charge	$I_D = 5$ A		10		
Q_{gd}	Gate-drain charge			10		
$t_{d(on)}$	Turn-on delay time	$V_{DD} = 2310$ V		16		ns
t_r	Voltage rise time	$V_{GS} = -5$ V/20 V		8		
$t_{d(off)}$	Turn-off delay time	$I_D = 10$ A		16		
t_f	Voltage fall time	$R_{g(ext)} = 16$ Ω		20		
E_{on}	Turn-on switching energy	Freewheeling diode = MSC400SMA330B4 ($V_{GS} = -5$ V) (reference Fig. 1-17)		750		μ J
E_{off}	Turn-off switching energy			120		
ESR	Gate equivalent series resistance	$f = 1$ MHz, 25 mV, drain short		3.7		Ω

The following table shows the body diode characteristics of the MSC400SMA330B4 device. $T_J = 25$ °C unless otherwise specified.

Table 1-5. Body Diode Characteristics

Symbol	Characteristic	Test Conditions	Min	Typ	Max	Unit
V_{SD}	Diode forward voltage	$I_{SD} = 5$ A, $V_{GS} = 0$ V		4.0		V
		$I_{SD} = 5$ A, $V_{GS} = -5$ V		4.0		
t_{rr}	Reverse recovery time	$I_{SD} = 10$ A, $V_{DD} = 2310$ V, Drive $R_g = 16$ Ω , $V_{GS} = -5$ V, $di/dt = -7900$ A/ μ s		14		ns
Q_{rr}	Reverse recovery charge			175		nC
I_{RRM}	Reverse recovery current				32	

1.3 Typical Performance Curves

This section shows the typical performance curves of the MSC400SMA330B4 device.

Figure 1-1. Drain Current vs. V_{DS} at T_J

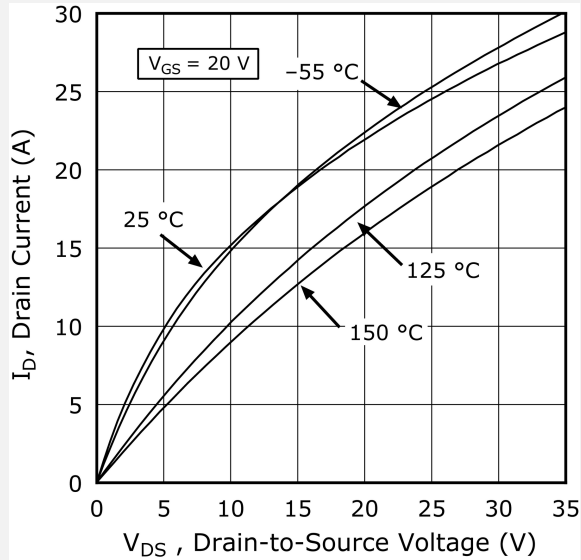

Figure 1-2. Drain Current vs. V_{DS} at V_{GS}

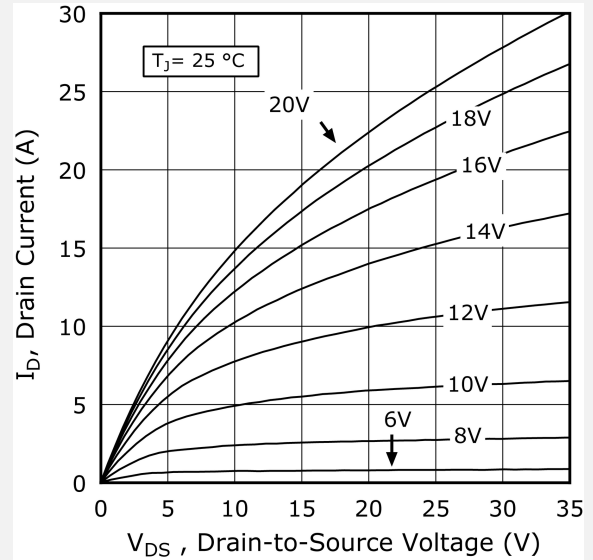

Figure 1-3. Drain Current vs. V_{DS} at V_{GS}

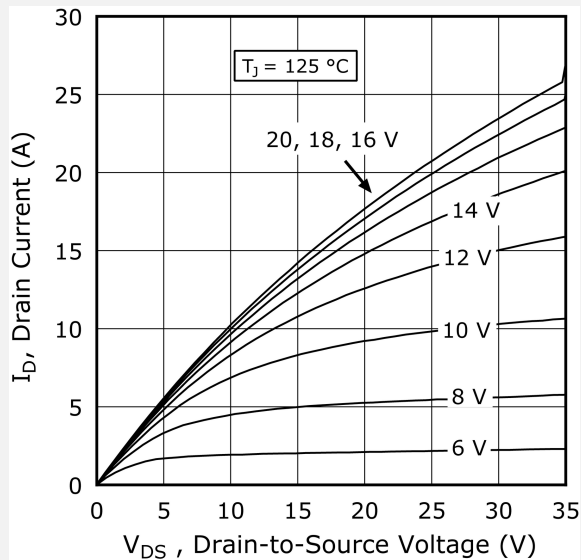

Figure 1-4. Drain Current vs. V_{DS} at V_{GS}

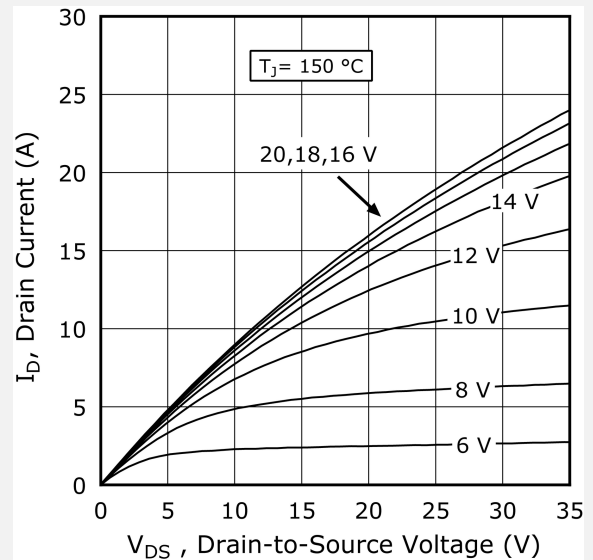

Figure 1-5. $R_{DS(on)}$ vs. Junction Temperature

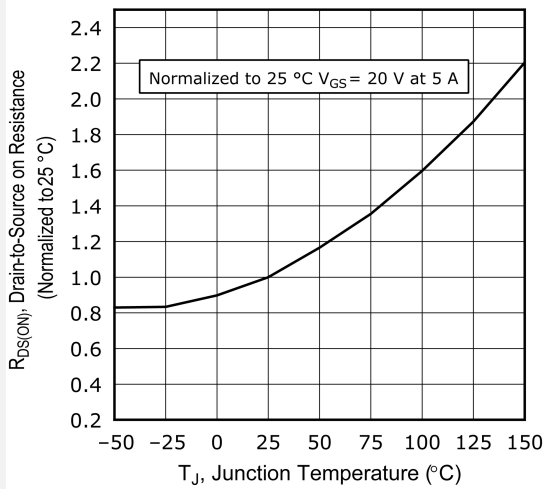

Figure 1-6. Gate Charge Characteristics

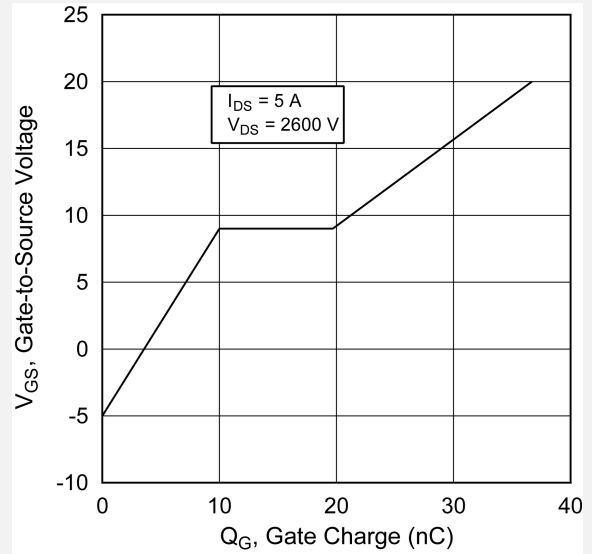

Figure 1-7. Capacitance vs. Drain-to-Source Voltage

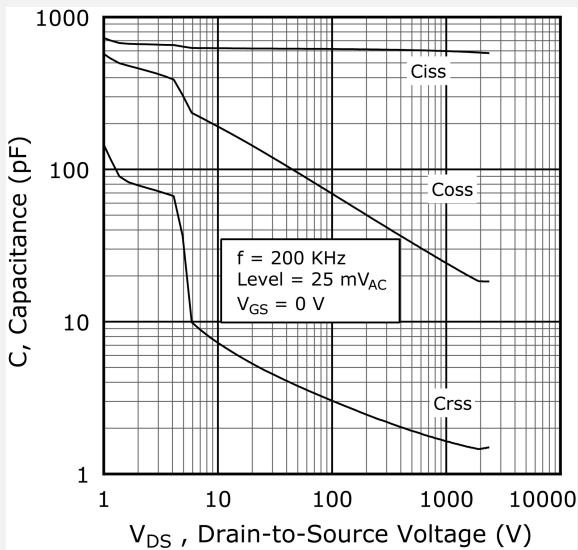

Figure 1-8. I_D vs. V_{DS} 3rd Quadrant Conduction

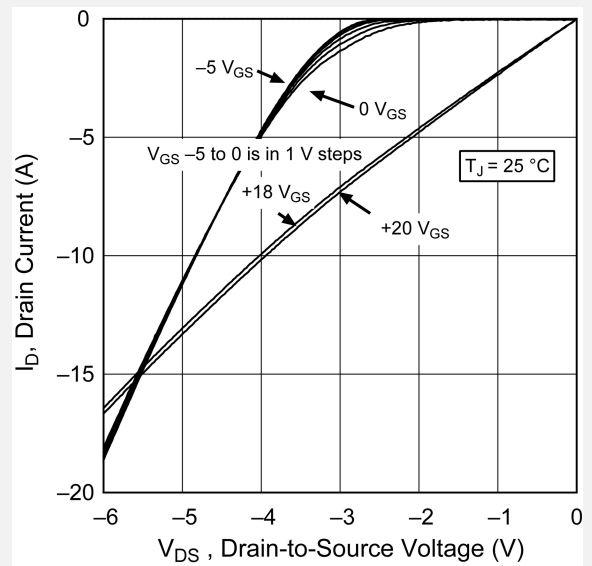

Figure 1-9. I_D vs. V_{DS} 3rd Quadrant Conduction

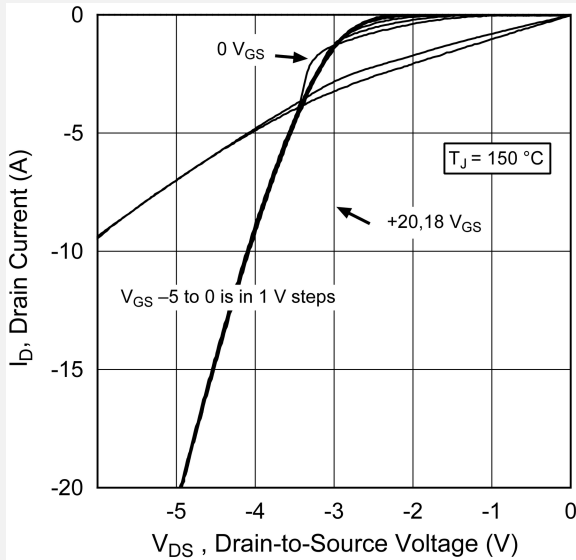

Figure 1-10. Switching Energy E_{on} vs. V_{DS} & I_D

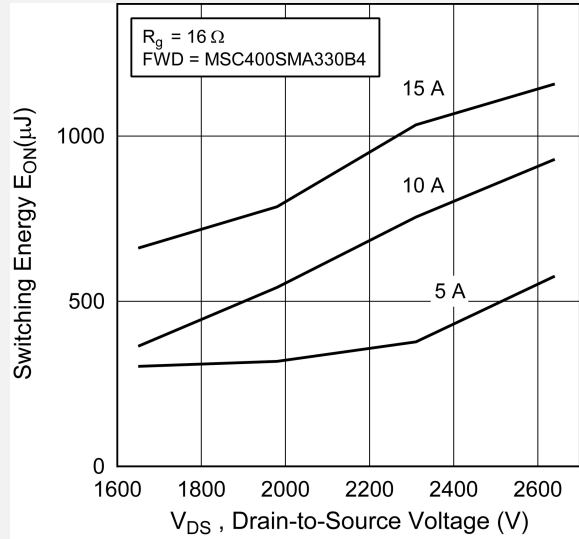

Figure 1-11. Switching Energy E_{off} vs. V_{DS} & I_D

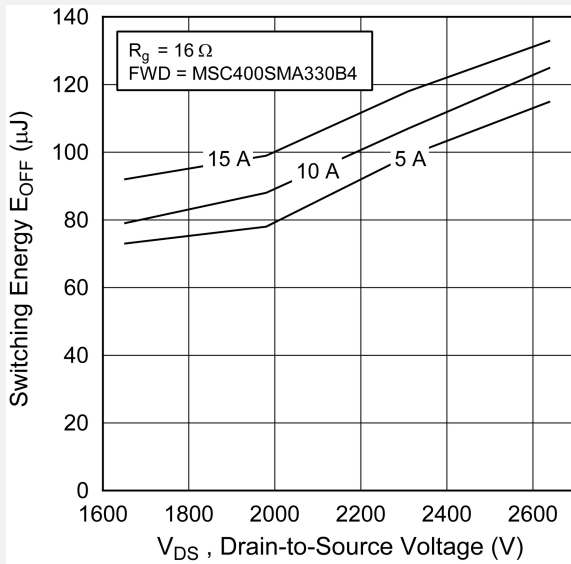

Figure 1-12. Switching Energy vs. R_g

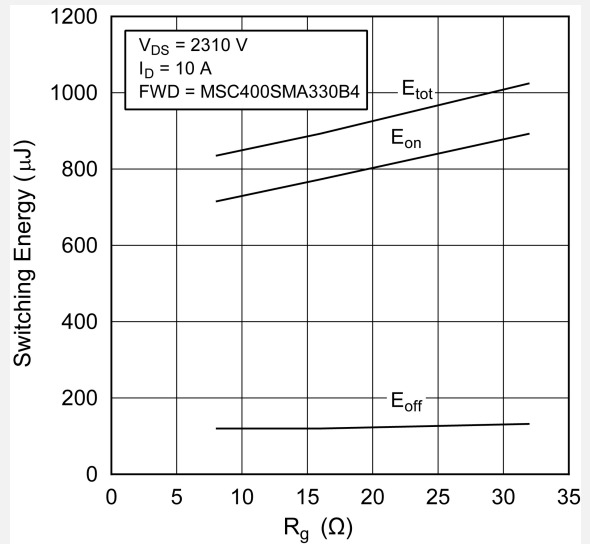

Figure 1-13. Switching Energy vs. Temperature

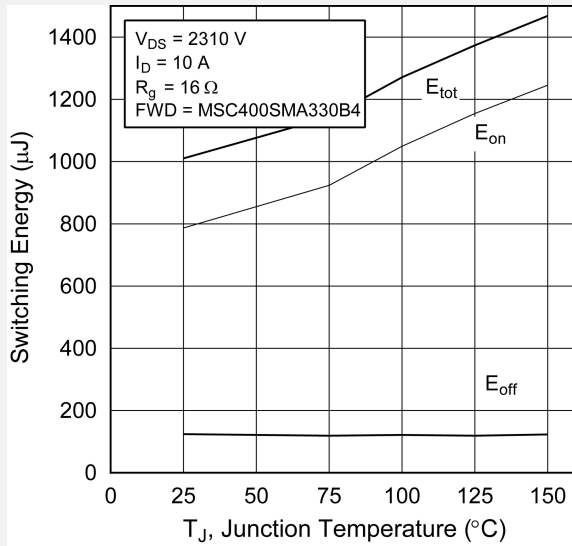

Figure 1-14. Threshold Voltage vs. Junction Temp.

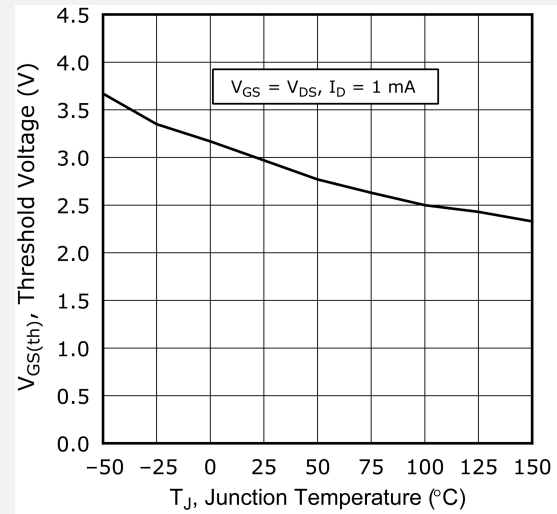

Figure 1-15. Forward Safe Operating Area

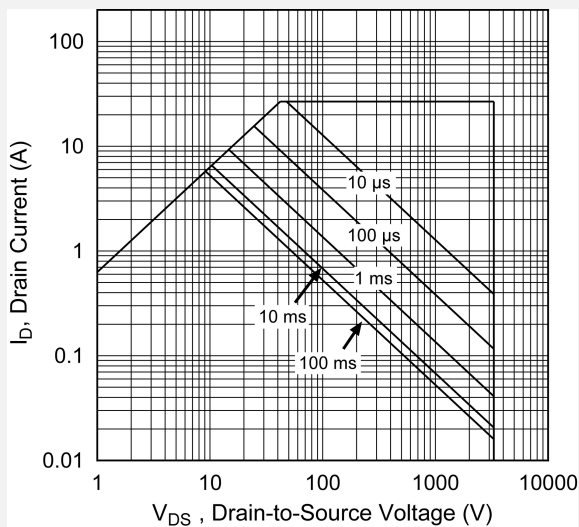
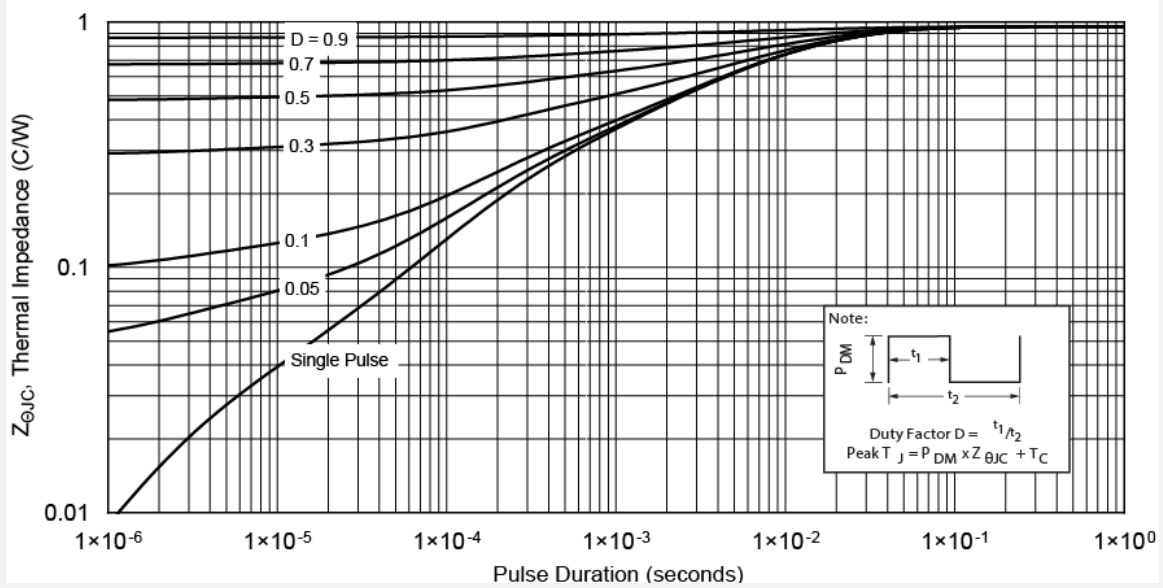
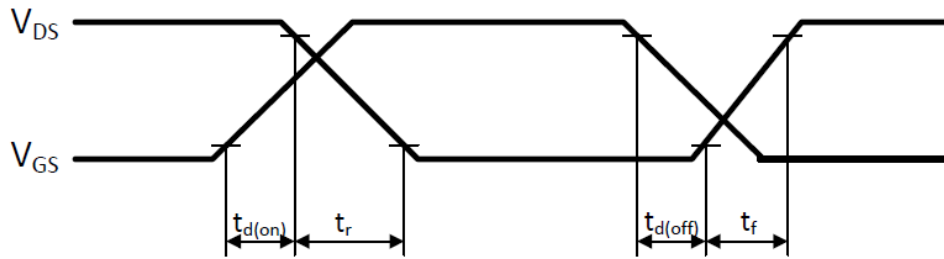

Figure 1-16. Maximum Transient Thermal Impedance



The following figure shows the switching waveform diagram of the MSC400SMA330B4 device.

Figure 1-17. Switching Waveform



2. Package Specification

This section shows the package specification of the MSC400SMA330B4 device.

2.1 Package Outline Drawing

The following figure illustrates the TO-247-4L package outline of the MSC400SMA330B4 device.

Figure 2-1. Package Outline Drawing

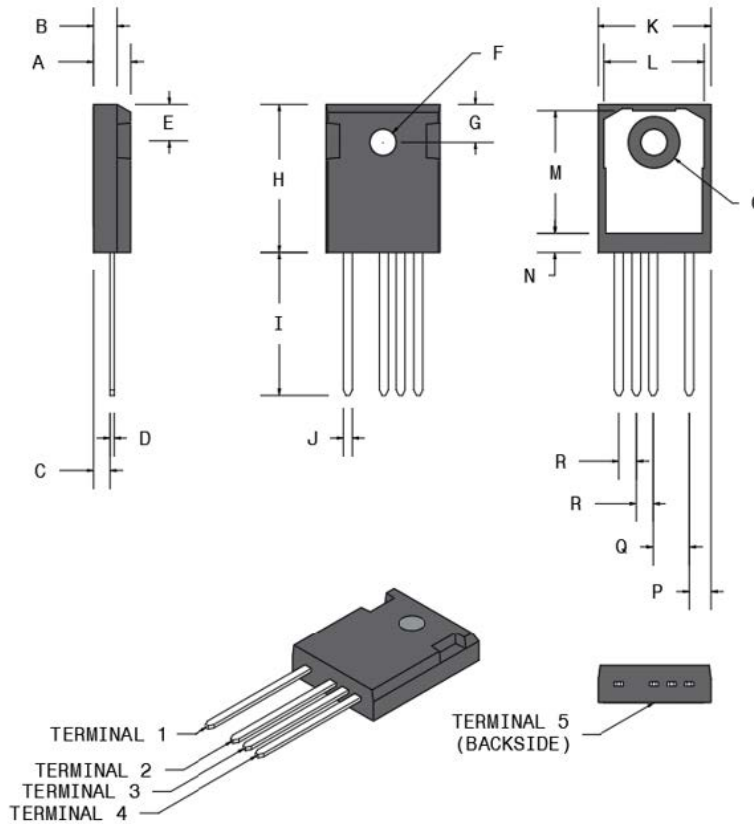

The following table shows the TO-247-4L dimensions and should be used in conjunction with the package outline drawing.

Table 2-1. TO-247-4L Dimensions

Symbol	Min (mm)	Max (mm)	Min (in.)	Max (in.)
A	4.90	5.17	0.193	0.204
B	1.85	2.11	0.073	0.083
C	2.25	2.51	0.089	0.099
D	0.55	0.68	0.022	0.027
E	5.49	5.74	0.216	0.226
F	3.56	3.66	0.140	0.144
G	6.15 BSC		0.242 BSC	
H	20.83	21.08	0.820	0.830

MSC400SMA330B4

Package Specification

.....continued				
Symbol	Min (mm)	Max (mm)	Min (in.)	Max (in.)
I	19.81	20.32	0.780	0.800
J	1.07	1.33	0.042	0.052
K	15.77	16.03	0.621	0.631
L	13.89	14.15	0.547	0.557
M	16.25	16.85	0.640	0.663
N	2.00	2.75	0.079	0.108
O	7.10	7.50	0.280	0.295
P	2.87 BSC		0.113 BSC	
Q	5.08 BSC		0.200 BSC	
R	2.54 BSC		0.100 BSC	
Terminal 1	Drain			
Terminal 2	Source			
Terminal 3	Source sense			
Terminal 4	Gate			
Terminal 5	Drain			

3. Revision History

Table 3-1. Revision History

Revision	Date	Description
A	02/2022	Document created.

The Microchip Website

Microchip provides online support via our website at www.microchip.com/. This website is used to make files and information easily available to customers. Some of the content available includes:

- **Product Support** – Data sheets and errata, application notes and sample programs, design resources, user's guides and hardware support documents, latest software releases and archived software
- **General Technical Support** – Frequently Asked Questions (FAQs), technical support requests, online discussion groups, Microchip design partner program member listing
- **Business of Microchip** – Product selector and ordering guides, latest Microchip press releases, listing of seminars and events, listings of Microchip sales offices, distributors and factory representatives

Product Change Notification Service

Microchip's product change notification service helps keep customers current on Microchip products. Subscribers will receive email notification whenever there are changes, updates, revisions or errata related to a specified product family or development tool of interest.

To register, go to www.microchip.com/pcn and follow the registration instructions.

Customer Support

Users of Microchip products can receive assistance through several channels:

- Distributor or Representative
- Local Sales Office
- Embedded Solutions Engineer (ESE)
- Technical Support

Customers should contact their distributor, representative or ESE for support. Local sales offices are also available to help customers. A listing of sales offices and locations is included in this document.

Technical support is available through the website at: www.microchip.com/support

Microchip Devices Code Protection Feature

Note the following details of the code protection feature on Microchip devices:

- Microchip products meet the specifications contained in their particular Microchip Data Sheet.
- Microchip believes that its family of products is secure when used in the intended manner and under normal conditions.
- There are dishonest and possibly illegal methods being used in attempts to breach the code protection features of the Microchip devices. We believe that these methods require using the Microchip products in a manner outside the operating specifications contained in Microchip's Data Sheets. Attempts to breach these code protection features, most likely, cannot be accomplished without violating Microchip's intellectual property rights.
- Microchip is willing to work with any customer who is concerned about the integrity of its code.
- Neither Microchip nor any other semiconductor manufacturer can guarantee the security of its code. Code protection does not mean that we are guaranteeing the product is "unbreakable." Code protection is constantly evolving. We at Microchip are committed to continuously improving the code protection features of our products. Attempts to break Microchip's code protection feature may be a violation of the Digital Millennium Copyright Act. If such acts allow unauthorized access to your software or other copyrighted work, you may have a right to sue for relief under that Act.

Legal Notice

Information contained in this publication is provided for the sole purpose of designing with and using Microchip products. Information regarding device applications and the like is provided only for your convenience and may be superseded by updates. It is your responsibility to ensure that your application meets with your specifications.

THIS INFORMATION IS PROVIDED BY MICROCHIP "AS IS". MICROCHIP MAKES NO REPRESENTATIONS OR WARRANTIES OF ANY KIND WHETHER EXPRESS OR IMPLIED, WRITTEN OR ORAL, STATUTORY OR OTHERWISE, RELATED TO THE INFORMATION INCLUDING BUT NOT LIMITED TO ANY IMPLIED WARRANTIES OF NON-INFRINGEMENT, MERCHANTABILITY, AND FITNESS FOR A PARTICULAR PURPOSE OR WARRANTIES RELATED TO ITS CONDITION, QUALITY, OR PERFORMANCE.

IN NO EVENT WILL MICROCHIP BE LIABLE FOR ANY INDIRECT, SPECIAL, PUNITIVE, INCIDENTAL OR CONSEQUENTIAL LOSS, DAMAGE, COST OR EXPENSE OF ANY KIND WHATSOEVER RELATED TO THE INFORMATION OR ITS USE, HOWEVER CAUSED, EVEN IF MICROCHIP HAS BEEN ADVISED OF THE POSSIBILITY OR THE DAMAGES ARE FORESEEABLE. TO THE FULLEST EXTENT ALLOWED BY LAW, MICROCHIP'S TOTAL LIABILITY ON ALL CLAIMS IN ANY WAY RELATED TO THE INFORMATION OR ITS USE WILL NOT EXCEED THE AMOUNT OF FEES, IF ANY, THAT YOU HAVE PAID DIRECTLY TO MICROCHIP FOR THE INFORMATION. Use of Microchip devices in life support and/or safety applications is entirely at the buyer's risk, and the buyer agrees to defend, indemnify and hold harmless Microchip from any and all damages, claims, suits, or expenses resulting from such use. No licenses are conveyed, implicitly or otherwise, under any Microchip intellectual property rights unless otherwise stated.

Trademarks

The Microchip name and logo, the Microchip logo, Adaptec, AnyRate, AVR, AVR logo, AVR Freaks, BesTime, BitCloud, chipKIT, chipKIT logo, CryptoMemory, CryptoRF, dsPIC, FlashFlex, flexPWR, HELDO, IGLOO, JukeBlox, KeeLoq, Klear, LANCheck, LinkMD, maXStylus, maXTouch, MediaLB, megaAVR, Microsemi, Microsemi logo, MOST, MOST logo, MPLAB, OptoLyzer, PackeTime, PIC, picoPower, PICSTART, PIC32 logo, PolarFire, Prochip Designer, QTouch, SAM-BA, SenGenuity, SpyNIC, SST, SST Logo, SuperFlash, Symmetricom, SyncServer, Tachyon, TimeSource, tinyAVR, UNI/O, Vectron, and XMEGA are registered trademarks of Microchip Technology Incorporated in the U.S.A. and other countries.

AgileSwitch, APT, ClockWorks, The Embedded Control Solutions Company, EtherSynch, FlashTec, Hyper Speed Control, HyperLight Load, IntelliMOS, Libero, motorBench, mTouch, Powermite 3, Precision Edge, ProASIC, ProASIC Plus, ProASIC Plus logo, Quiet-Wire, SmartFusion, SyncWorld, Temux, TimeCesium, TimeHub, TimePictra, TimeProvider, WinPath, and ZL are registered trademarks of Microchip Technology Incorporated in the U.S.A.

Adjacent Key Suppression, AKS, Analog-for-the-Digital Age, Any Capacitor, AnyIn, AnyOut, Augmented Switching, BlueSky, BodyCom, CodeGuard, CryptoAuthentication, CryptoAutomotive, CryptoCompanion, CryptoController, dsPICDEM, dsPICDEM.net, Dynamic Average Matching, DAM, ECAN, Espresso T1S, EtherGREEN, IdealBridge, In-Circuit Serial Programming, ICSP, INICnet, Intelligent Paralleling, Inter-Chip Connectivity, JitterBlocker, maxCrypto, maxView, memBrain, Mindi, MiWi, MPASM, MPF, MPLAB Certified logo, MPLIB, MPLINK, MultiTRAK, NetDetach, Omniscient Code Generation, PICDEM, PICDEM.net, PICKit, PICtail, PowerSmart, PureSilicon, QMatrix, REAL ICE, Ripple Blocker, RTAX, RTG4, SAM-ICE, Serial Quad I/O, simpleMAP, SimpliPHY, SmartBuffer, SMART-I.S., storClad, SQL, SuperSwitcher, SuperSwitcher II, Switchtec, SynchroPHY, Total Endurance, TSHARC, USBCheck, VariSense, VectorBlox, VeriPHY, ViewSpan, WiperLock, XpressConnect, and ZENA are trademarks of Microchip Technology Incorporated in the U.S.A. and other countries.

SQTP is a service mark of Microchip Technology Incorporated in the U.S.A.

The Adaptec logo, Frequency on Demand, Silicon Storage Technology, and Symmcom are registered trademarks of Microchip Technology Inc. in other countries.

GestIC is a registered trademark of Microchip Technology Germany II GmbH & Co. KG, a subsidiary of Microchip Technology Inc., in other countries.

All other trademarks mentioned herein are property of their respective companies.

© 2022, Microchip Technology Incorporated, Printed in the U.S.A., All Rights Reserved.

ISBN: 978-1-5224-9733-2

Quality Management System

For information regarding Microchip's Quality Management Systems, please visit www.microchip.com/quality.

Worldwide Sales and Service

AMERICAS	ASIA/PACIFIC	ASIA/PACIFIC	EUROPE
<p>Corporate Office 2355 West Chandler Blvd. Chandler, AZ 85224-6199 Tel: 480-792-7200 Tel: 480-792-7277 Technical Support: www.microchip.com/support Web Address: www.microchip.com</p> <p>Atlanta Duluth, GA Tel: 678-957-9614 Fax: 678-957-1455</p> <p>Austin, TX Tel: 512-257-3370</p> <p>Boston Westborough, MA Tel: 774-760-0087 Fax: 774-760-0088</p> <p>Chicago Itasca, IL Tel: 630-285-0071 Fax: 630-285-0075</p> <p>Dallas Addison, TX Tel: 972-818-7423 Fax: 972-818-2924</p> <p>Detroit Novi, MI Tel: 248-848-4000</p> <p>Houston, TX Tel: 281-894-5983</p> <p>Indianapolis Noblesville, IN Tel: 317-773-8323 Fax: 317-773-5453 Tel: 317-536-2380</p> <p>Los Angeles Mission Viejo, CA Tel: 949-462-9523 Fax: 949-462-9608 Tel: 951-273-7800</p> <p>Raleigh, NC Tel: 919-844-7510</p> <p>New York, NY Tel: 631-435-6000</p> <p>San Jose, CA Tel: 408-735-9110 Tel: 408-436-4270</p> <p>Canada - Toronto Tel: 905-695-1980 Fax: 905-695-2078</p>	<p>Australia - Sydney Tel: 61-2-9868-6733</p> <p>China - Beijing Tel: 86-10-8569-7000</p> <p>China - Chengdu Tel: 86-28-8665-5511</p> <p>China - Chongqing Tel: 86-23-8980-9588</p> <p>China - Dongguan Tel: 86-769-8702-9880</p> <p>China - Guangzhou Tel: 86-20-8755-8029</p> <p>China - Hangzhou Tel: 86-571-8792-8115</p> <p>China - Hong Kong SAR Tel: 852-2943-5100</p> <p>China - Nanjing Tel: 86-25-8473-2460</p> <p>China - Qingdao Tel: 86-532-8502-7355</p> <p>China - Shanghai Tel: 86-21-3326-8000</p> <p>China - Shenyang Tel: 86-24-2334-2829</p> <p>China - Shenzhen Tel: 86-755-8864-2200</p> <p>China - Suzhou Tel: 86-186-6233-1526</p> <p>China - Wuhan Tel: 86-27-5980-5300</p> <p>China - Xian Tel: 86-29-8833-7252</p> <p>China - Xiamen Tel: 86-592-2388138</p> <p>China - Zhuhai Tel: 86-756-3210040</p>	<p>India - Bangalore Tel: 91-80-3090-4444</p> <p>India - New Delhi Tel: 91-11-4160-8631</p> <p>India - Pune Tel: 91-20-4121-0141</p> <p>Japan - Osaka Tel: 81-6-6152-7160</p> <p>Japan - Tokyo Tel: 81-3-6880-3770</p> <p>Korea - Daegu Tel: 82-53-744-4301</p> <p>Korea - Seoul Tel: 82-2-554-7200</p> <p>Malaysia - Kuala Lumpur Tel: 60-3-7651-7906</p> <p>Malaysia - Penang Tel: 60-4-227-8870</p> <p>Philippines - Manila Tel: 63-2-634-9065</p> <p>Singapore Tel: 65-6334-8870</p> <p>Taiwan - Hsin Chu Tel: 886-3-577-8366</p> <p>Taiwan - Kaohsiung Tel: 886-7-213-7830</p> <p>Taiwan - Taipei Tel: 886-2-2508-8600</p> <p>Thailand - Bangkok Tel: 66-2-694-1351</p> <p>Vietnam - Ho Chi Minh Tel: 84-28-5448-2100</p>	<p>Austria - Wels Tel: 43-7242-2244-39 Fax: 43-7242-2244-393</p> <p>Denmark - Copenhagen Tel: 45-4485-5910 Fax: 45-4485-2829</p> <p>Finland - Espoo Tel: 358-9-4520-820</p> <p>France - Paris Tel: 33-1-69-53-63-20 Fax: 33-1-69-30-90-79</p> <p>Germany - Garching Tel: 49-8931-9700</p> <p>Germany - Haan Tel: 49-2129-3766400</p> <p>Germany - Heilbronn Tel: 49-7131-72400</p> <p>Germany - Karlsruhe Tel: 49-721-625370</p> <p>Germany - Munich Tel: 49-89-627-144-0 Fax: 49-89-627-144-44</p> <p>Germany - Rosenheim Tel: 49-8031-354-560</p> <p>Israel - Ra'anana Tel: 972-9-744-7705</p> <p>Italy - Milan Tel: 39-0331-742611 Fax: 39-0331-466781</p> <p>Italy - Padova Tel: 39-049-7625286</p> <p>Netherlands - Drunen Tel: 31-416-690399 Fax: 31-416-690340</p> <p>Norway - Trondheim Tel: 47-72884388</p> <p>Poland - Warsaw Tel: 48-22-3325737</p> <p>Romania - Bucharest Tel: 40-21-407-87-50</p> <p>Spain - Madrid Tel: 34-91-708-08-90 Fax: 34-91-708-08-91</p> <p>Sweden - Gothenberg Tel: 46-31-704-60-40</p> <p>Sweden - Stockholm Tel: 46-8-5090-4654</p> <p>UK - Wokingham Tel: 44-118-921-5800 Fax: 44-118-921-5820</p>