



NJG1186PJL

GNSS L5/L2C Band Front-End Module

FEATURES

- Wide-operating frequency range
1164 to 1228 MHz (L5/E5/B2/G3/L2C)
- Supply voltage 2.8 V typ.
- Current consumption 4.8 mA typ.
- High gain
19.5 dB typ. @ f = 1164 to 1214 MHz
19.0 dB typ. @ f = 1228 MHz
- Low noise figure
1.7 dB typ. @ f = 1164 to 1214 MHz
2.0 dB typ. @ f = 1228 MHz
- High out band rejection relative to 1176 MHz
45 dBc typ. @ f = 704 to 915 MHz
50 dBc typ. @ f = 1559 to 1606 MHz
55 dBc typ. @ f = 1710 to 1980 MHz
67 dBc typ. @ f = 2400 to 2500 MHz
- Integrated pre-SAW filter and LNA
- High reliability metal hermetic-sealed package
1.57 x 1.23 mm typ., t = 0.47 mm max.
- RoHS compliant and Halogen Free, MSL1

GENERAL DESCRIPTION

The NJG1186PJL is a front-end module (FEM) designed for GNSS L5/L2C band applications.

This FEM offers low noise figure, high linearity, and high out-band rejection characteristics brought by integrated high performance pre-SAW filter and low noise amplifier (LNA). Wide-operating frequency allows to work in various bands such as L5/E5/B2/G3/L2C. The stand-by mode contributes to reduce current consumption.

Its wide operating temperature range from -40 to +105°C allows to operate in various environment including outdoor solutions.

This FEM is suitable for small size applications by included one SAW filter, several external components, and very small package HFFP10-JL. This metal hermetic-sealed package brings high reliability and stable performance against humidity.

APPLICATIONS

- GPS, GLONASS, Beidou, Galileo
- GNSS L5/L2C band application
- GNSS active antenna
- GNSS Module
- Tracking device
- Timing module

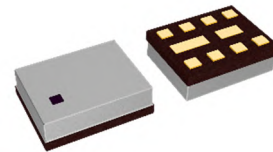

HFFP10-JL
1.57 x 1.23 mm typ., t = 0.47 mm max.

BLOCK DIAGRAM

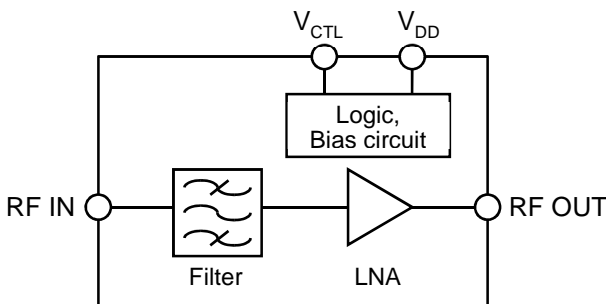

■ PRODUCT NAME INFORMATION

NJG1186 PJL (TE1)

Description of configuration

Suffix	Item	Description
PJL	Package code	Indicating the package. Refer to the order information for detail.
(TE1)	Packing	Refer to the packing specifications for detail.

■ ORDER INFORMATION

PRODUCT NAME	PACKAGE	RoHS	HALOGEN-FREE	PLATING COMPOSITION	MARKING	WEIGHT (mg)	Quantity per Reel (pcs)
NJG1186PJL	HFFP10-JL	Yes	Yes	Au	86J	4.4	3000

■ PIN DESCRIPTIONS

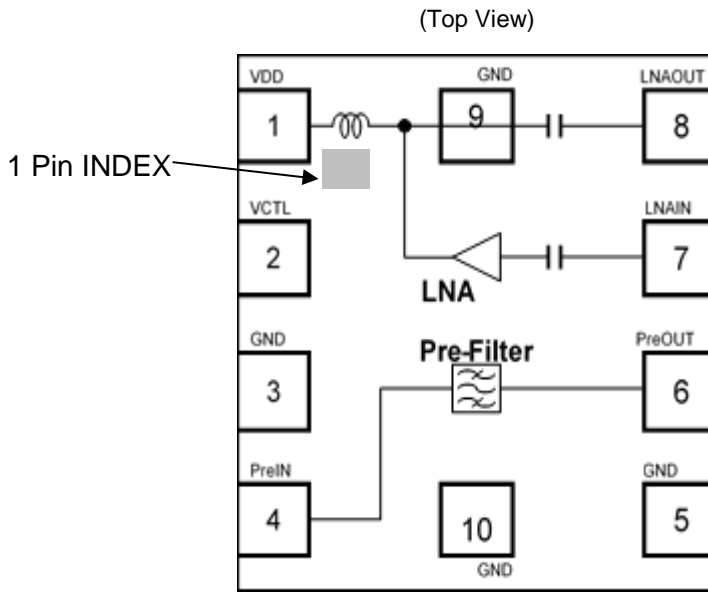

HFFP10-JL Pin Configuration

Pin No.	Pin Name	Description
1	VDD	Supply voltage terminal
2	VCTL	Control voltage terminal
3	GND	Ground terminal
4	PreIN	RF input terminal to Pre-SAW filter
5	GND	Ground terminal
6	PreOUT	RF output terminal from Pre-SAW filter
7	LNAIN	RF input terminal to LNA
8	LNAOUT	RF output terminal from LNA
9	GND	Ground terminal
10	GND	Ground terminal

Please refer to "APPLICATION CIRCUIT"

■ TRUTH TABLE

"H"= $V_{CTL}(H)$, "L"= $V_{CTL}(L)$

V_{CTL}	Mode
H	Active mode
L	Stand-by mode

■ ABSOLUTE MAXIMUM RATINGS

$T_a = +25^{\circ}\text{C}$, $Z_s = Z_l = 50 \Omega$

Parameter	Symbol	Ratings	Unit
Supply voltage	V_{DD}	5.0	V
Control voltage	V_{CTL}	5.0	V
Input power	P_{IN} (inband) ⁽¹⁾	+10	dBm
	P_{IN} (outband) ⁽²⁾	+25	dBm
Power dissipation	P_D ⁽³⁾	560	mW
Operating temperature	T_{opr}	-40 to +105	$^{\circ}\text{C}$
Storage temperature	T_{stg}	-40 to +110	$^{\circ}\text{C}$

(1): $V_{DD} = 2.8 \text{ V}$, $f = 1164 \text{ to } 1227.6 \text{ MHz}$

(2): $V_{DD} = 2.8 \text{ V}$, $f = 50 \text{ to } 960 \text{ MHz}$, $1427 \text{ to } 5000 \text{ MHz}$

(3): 4-layer FR4 PCB without through-hole (101.5 x 114.5 mm), $T_j = +110^{\circ}\text{C}$

ABSOLUTE MAXIMUM RATINGS

Electronic and mechanical stress momentarily exceeded absolute maximum ratings may cause permanent damage and may degrade the lifetime and safety for both device and system using the device in the field. The functional operation at or over these absolute maximum ratings is not assured.

Please calculate the power consumption of the IC from the operating conditions, and calculate the junction temperature with the thermal resistance.

Please refer to "*Thermal characteristics*" for the thermal resistance under our conditions.

■ THERMAL CHARACTERISTICS

Parameter	Value
Thermal Resistance (θ_{ja})	$\theta_{ja} = 151.8^{\circ}\text{C/W}$

θ_{ja} : Junction-to-Ambient Thermal Resistance

■ RECOMMENDED OPERATING CONDITIONS

Parameter	Symbol	Value	Unit
Supply voltage	V_{DD}	1.5 to 3.3	V
Control voltage	V_{CTL}	1.5 to 3.3	V
Ambient Operating Temperature	T_a	-40 to +105	$^{\circ}\text{C}$

RECOMMENDED OPERATING CONDITIONS

All of electronic equipment should be designed that the mounted semiconductor devices operate within the recommended operating conditions. The semiconductor devices cannot operate normally over the recommended operating conditions, even if when they are used over such conditions by momentary electronic noise or surge. And the semiconductor devices may receive serious damage when they continue to operate over the recommended operating conditions.

■ ELECTRICAL CHARACTERISTICS 1 (DC)

General conditions: $T_a = +25^{\circ}\text{C}$, with typical application circuit

Parameter	Symbol	Condition	MIN	TYP	MAX	Unit
Supply Voltage	V_{DD}		1.5	2.8	3.3	V
Control Voltage (High)	$V_{CTL(H)}$		1.5	1.8	3.3	V
Control Voltage (Low)	$V_{CTL(L)}$		0	0	0.3	V
Supply Current	I_{DD}	RF OFF $V_{DD} = 2.8\text{ V}, V_{CTL(H)} = 1.8\text{ V}$	-	4.8	7.5	mA
		RF OFF $V_{DD} = 1.8\text{ V}, V_{CTL(H)} = 1.8\text{ V}$	-	3.8	7.0	mA
		RF OFF $V_{DD} = 2.8\text{ V}, V_{CTL(L)} = 0\text{ V}$	-	0.1	5.0	μA
		RF OFF $V_{DD} = 1.8\text{ V}, V_{CTL(L)} = 0\text{ V}$	-	0.1	5.0	μA
Control Current	I_{CTL}	RF OFF $V_{DD} = 2.8/1.8\text{ V}, V_{CTL(H)} = 1.8\text{ V}$	-	5.0	15.0	μA

■ Electrical characteristics 2 (RF)

General conditions: $V_{DD} = 2.8\text{ V}, V_{CTL(H)} = 1.8\text{ V}, T_a = +25^{\circ}\text{C}, Z_s = Z_l = 50\ \Omega$, with typical application circuit

Parameter	Symbol	Condition	MIN	TYP	MAX	Unit
Small Signal Gain	Gain	$f_{RF} = 1164\text{ to }1214\text{ MHz (L5/E5/B2/G3)}$ Exclude PCB, Connector Losses ⁽⁴⁾	-	19.5	-	dB
		$f_{RF} = 1227.6\text{ MHz (L2C)}$ Exclude PCB, Connector Losses ⁽⁴⁾	-	19.0	-	dB
Noise Figure	NF	$f_{RF} = 1164\text{ to }1214\text{ MHz (L5/E5/B2/G3)}$ Exclude PCB, Connector Losses ⁽⁵⁾	-	1.7	-	dB
		$f_{RF} = 1227.6\text{ MHz (L2C)}$ Exclude PCB, Connector Losses ⁽⁵⁾	-	2.0	-	dB
Input Power at 1dB Gain Compression Point	P-1dB(IN)	$f_{RF} = 1164\text{ to }1214\text{ MHz}, 1227.6\text{ MHz}$	-	-12	-	dBm
Input 3rd Order Intercept Point	IIP3	$f_{RF1} = 1164\text{ to }1214\text{ MHz}, 1227.6\text{ MHz}$ $f_{RF2} = f_{RF1} \pm 1\text{ MHz}, P_{in} = -30\text{ dBm}$	-	-3	-	dBm
Out-of-Band Rejection	BR	$f_{RF} = 704\text{ to }915\text{ MHz}$, relative to 1176 MHz	-	45	-	dBc
		$f_{RF} = 1559\text{ to }1606\text{ MHz}$, relative to 1176 MHz	-	50	-	dBc
		$f_{RF} = 1710\text{ to }1980\text{ MHz}$, relative to 1176 MHz	-	55	-	dBc
		$f_{RF} = 2400\text{ to }2500\text{ MHz}$, relative to 1176 MHz	-	67	-	dBc
RF IN Return Loss	RLi	$f_{RF} = 1164\text{ to }1214\text{ MHz (L5/E5/B2/G3)}$	-	14	-	dB
		$f_{RF} = 1227.6\text{ MHz (L2C)}$	-	12	-	dB
RF OUT Return Loss	RLo	$f_{RF} = 1164\text{ to }1214\text{ MHz (L5/E5/B2/G3)}$	-	19	-	dB
		$f_{RF} = 1227.6\text{ MHz (L2C)}$	-	16	-	dB
Group Delay Time Deviation	GDTD	$f_{RF} = 1164\text{ to }1189\text{ MHz (L5/E5a/B2a)}$	-	8.5	-	ns
		$f_{RF} = 1189\text{ to }1214\text{ MHz (E5b/B2b/G3)}$	-	4	-	ns

(4) PCB, Connector Losses: 0.13 dB

(5) PCB, Connector Losses: 0.07 dB

■ Electrical characteristics 3 (RF)

General conditions: $V_{DD} = 1.8\text{ V}$, $V_{CTL(H)} = 1.8\text{ V}$, $T_a = +25^\circ\text{C}$, $Z_s = Z_l = 50\ \Omega$, with typical application circuit

Parameter	Symbol	Condition	MIN	TYP	MAX	Unit
Small Signal Gain	Gain	$f_{RF} = 1164\text{ to }1214\text{ MHz (L5/E5/B2/G3)}$ Exclude PCB, Connector Losses ⁽⁴⁾	-	19.0	-	dB
		$f_{RF} = 1227.6\text{ MHz (L2C)}$ Exclude PCB, Connector Losses ⁽⁴⁾	-	18.5	-	dB
Noise Figure	NF	$f_{RF} = 1164\text{ to }1214\text{ MHz (L5/E5/B2/G3)}$ Exclude PCB, Connector Losses ⁽⁵⁾	-	1.7	-	dB
		$f_{RF} = 1227.6\text{ MHz (L2C)}$ Exclude PCB, Connector Losses ⁽⁵⁾	-	2.0	-	dB
Input Power at 1dB Gain Compression Point	P-1dB(IN)	$f_{RF} = 1164\text{ to }1214\text{ MHz, }1227.6\text{ MHz}$	-	-15.5	-	dBm
Input 3rd Order Intercept Point	IIP3	$f_{RF1} = 1164\text{ to }1214\text{ MHz, }1227.6\text{ MHz}$ $f_{RF2} = f_{RF1} \pm 1\text{ MHz, }P_{in} = -30\text{ dBm}$	-	-4.5	-	dBm
Out-of-Band Rejection	BR	$f_{RF} = 704\text{ to }915\text{ MHz,}$ relative to 1176 MHz	-	45	-	dBc
		$f_{RF} = 1559\text{ to }1606\text{ MHz,}$ relative to 1176 MHz	-	50	-	dBc
		$f_{RF} = 1710\text{ to }1980\text{ MHz,}$ relative to 1176 MHz	-	55	-	dBc
		$f_{RF} = 2400\text{ to }2500\text{ MHz,}$ relative to 1176 MHz	-	67	-	dBc
RF IN Return Loss	RLi	$f_{RF} = 1164\text{ to }1214\text{ MHz (L5/E5/B2/G3)}$	-	14	-	dB
		$f_{RF} = 1227.6\text{ MHz (L2C)}$	-	11	-	dB
RF OUT Return Loss	RLo	$f_{RF} = 1164\text{ to }1214\text{ MHz (L5/E5/B2/G3)}$	-	17	-	dB
		$f_{RF} = 1227.6\text{ MHz (L2C)}$	-	15	-	dB
Group Delay Time Deviation	GDTD	$f_{RF} = 1164\text{ to }1189\text{ MHz (L5/E5a/B2a)}$	-	8.5	-	ns
		$f_{RF} = 1189\text{ to }1214\text{ MHz (E5b/B2b/G3)}$	-	4	-	ns

(4) PCB, Connector Losses: 0.13 dB

(5) PCB, Connector Losses: 0.07 dB

■ TYPICAL CHARACTERISTICS

Conditions: $V_{DD} = 2.8\text{ V}$, $V_{CTL} = 1.8\text{ V}$, $T_a = 25^\circ\text{C}$, $Z_s = Z_l = 50\ \Omega$, with application circuit

Note: Typical Characteristics are intended to be used as reference data; they are not guaranteed.

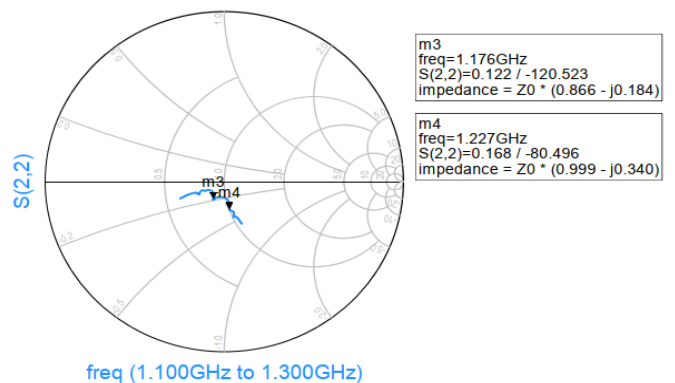
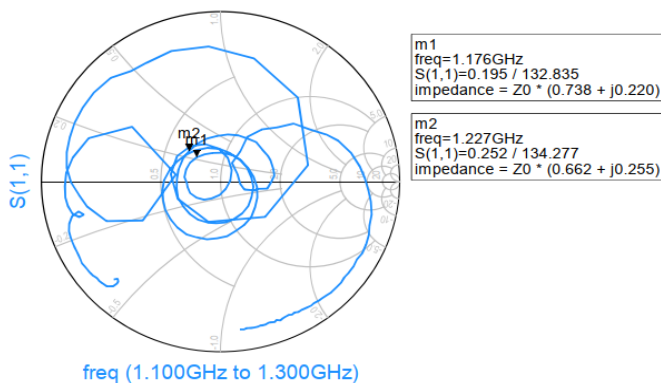
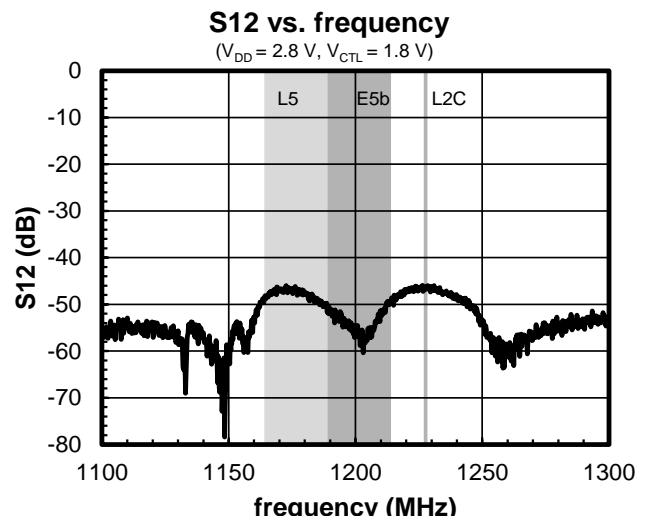
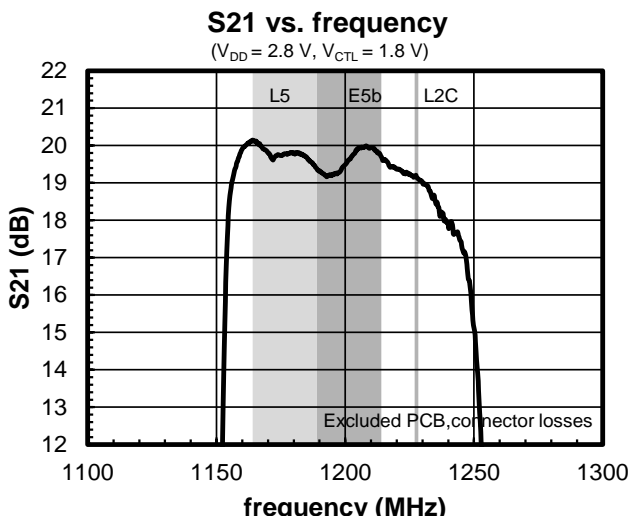
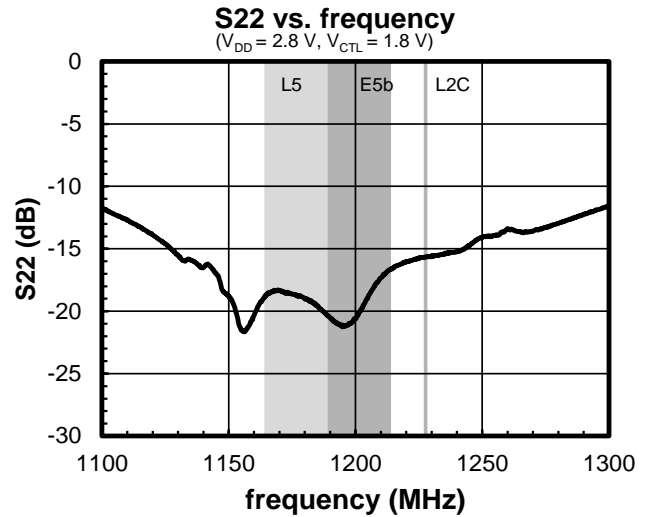
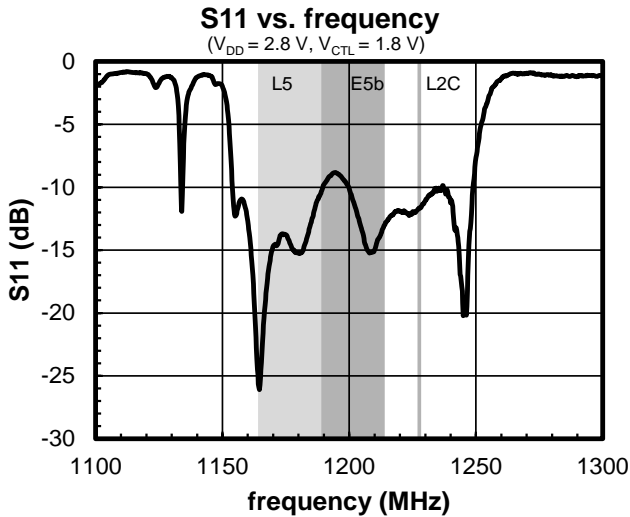

■ TYPICAL CHARACTERISTICS

Conditions: $V_{DD} = 2.8\text{ V}$, $V_{CTL} = 1.8\text{ V}$, $T_a = 25^\circ\text{C}$, $Z_s = Z_l = 50\ \Omega$, with application circuit

Note: Typical Characteristics are intended to be used as reference data; they are not guaranteed.

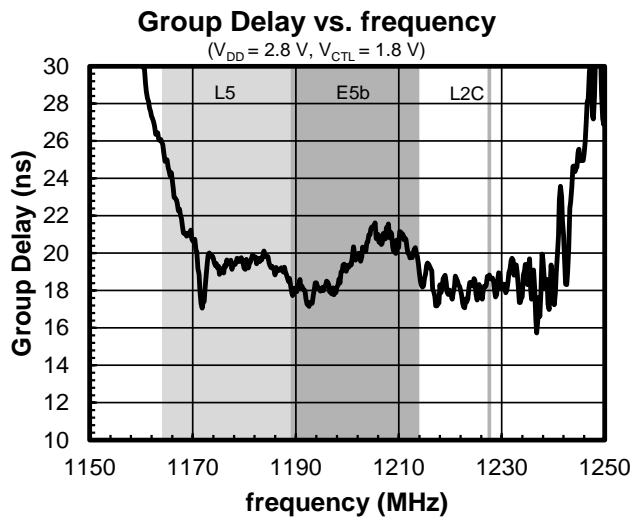
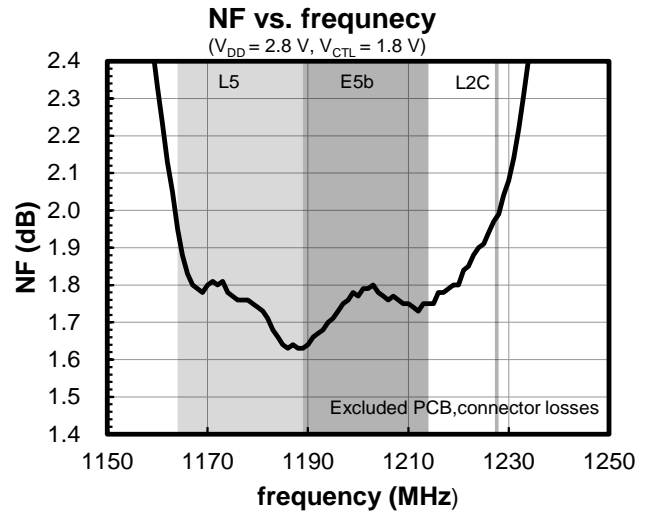
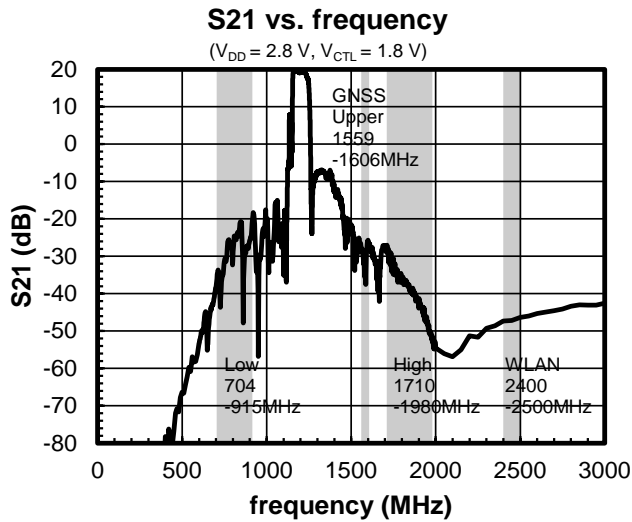

■ TYPICAL CHARACTERISTICS

Conditions: $V_{DD} = 2.8\text{ V}$, $V_{CTL} = 1.8\text{ V}$, $T_a = 25^\circ\text{C}$, $Z_s = Z_l = 50\ \Omega$, with application circuit

Note: Typical Characteristics are intended to be used as reference data; they are not guaranteed.

Pout, I_{DD} vs. Pin

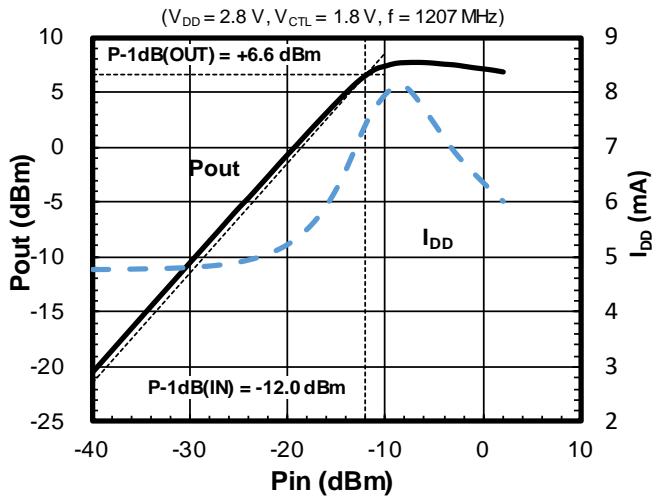

Gain, I_{DD} vs. Pin

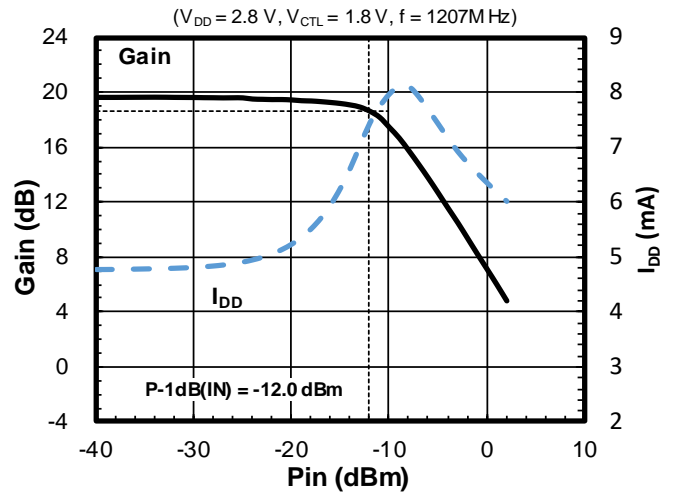

Pout, IM3 vs. Pin

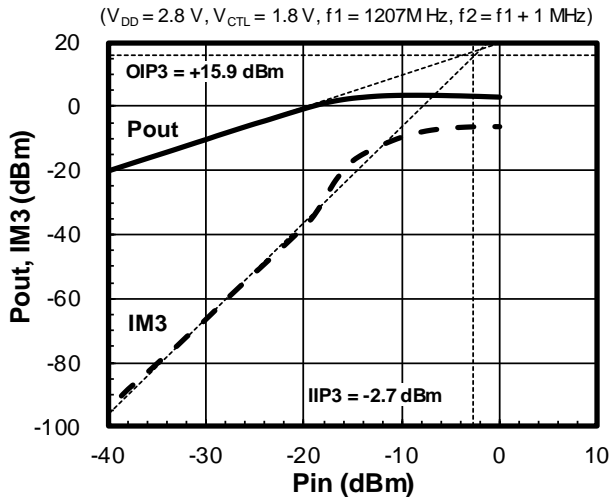

P-1dB(IN) vs. frequency

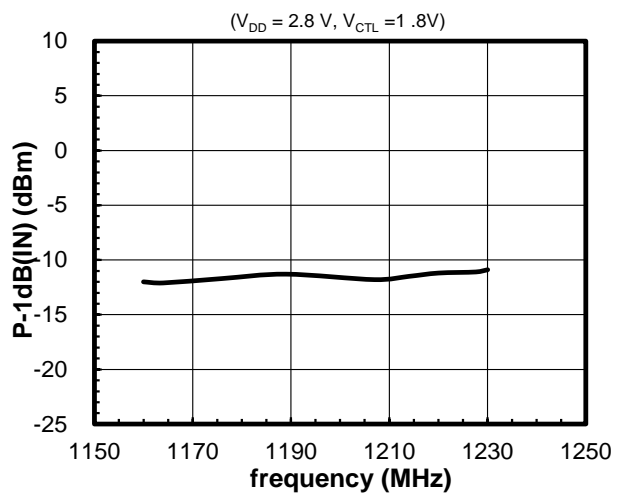

IIP3, OIP3 vs. frequency

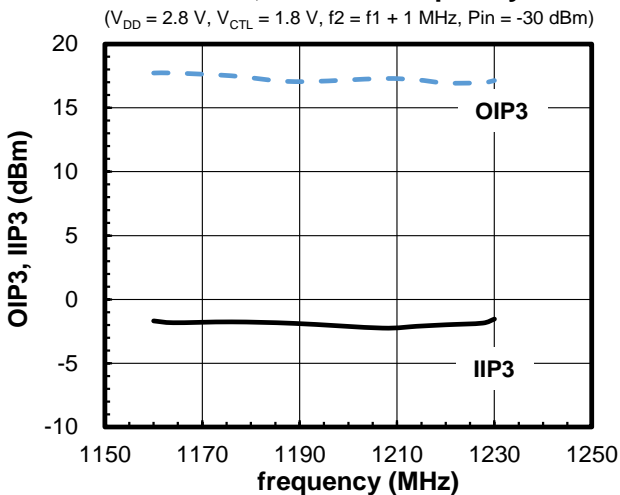

■ TYPICAL CHARACTERISTICS

Conditions: $V_{DD} = 1.8\text{ V}$, $V_{CTL} = 1.8\text{ V}$, $T_a = 25^\circ\text{C}$, $Z_s = Z_l = 50\ \Omega$, with application circuit

Note: Typical Characteristics are intended to be used as reference data; they are not guaranteed.

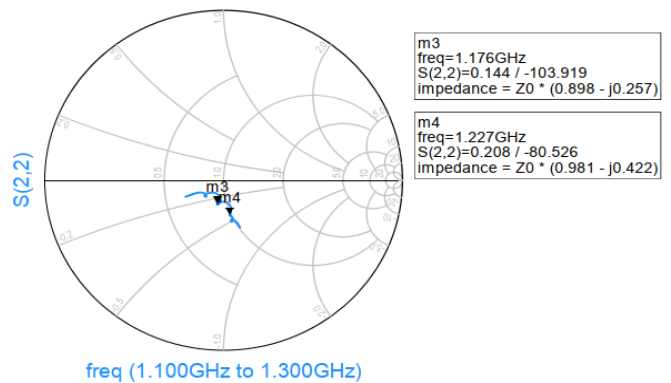
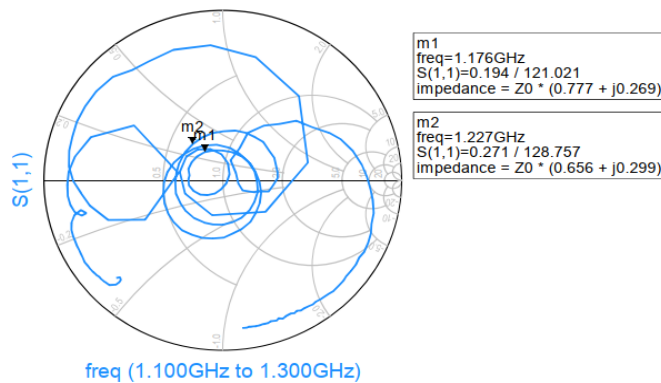
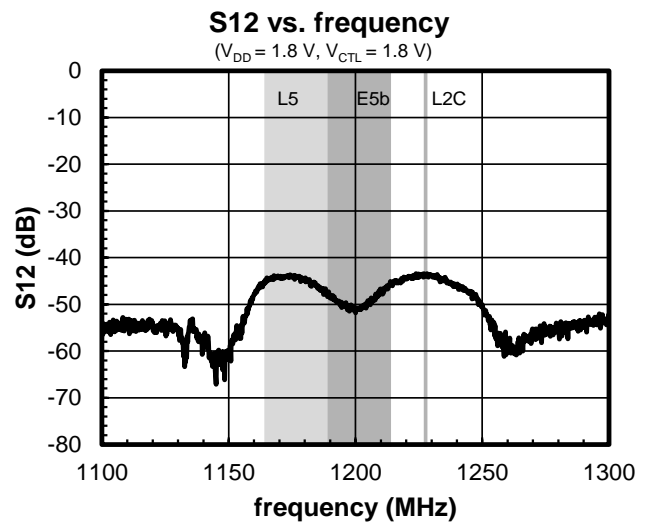
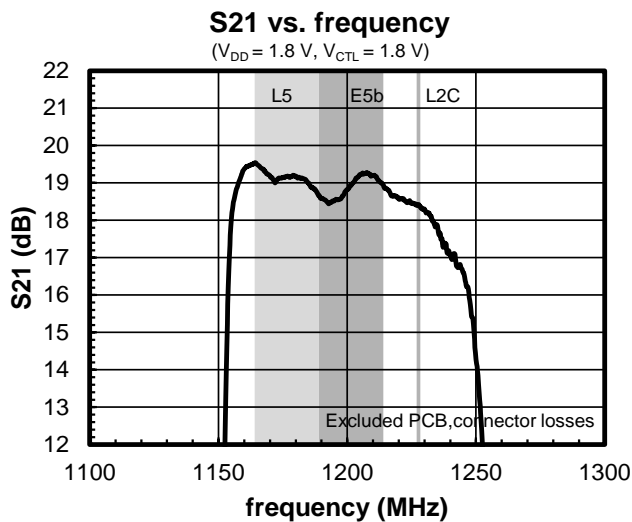
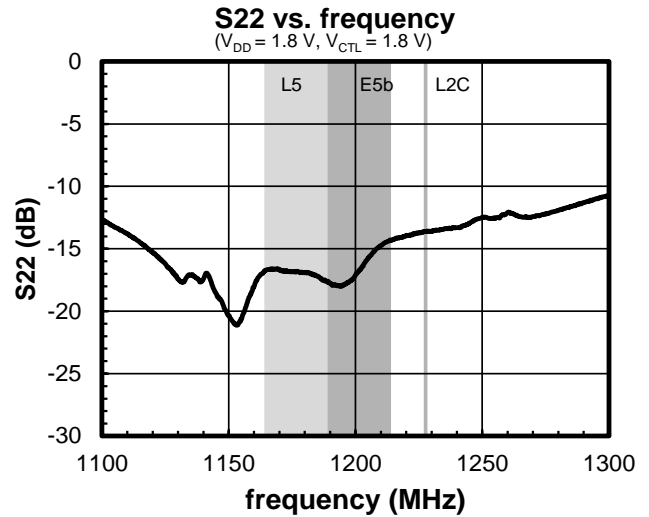
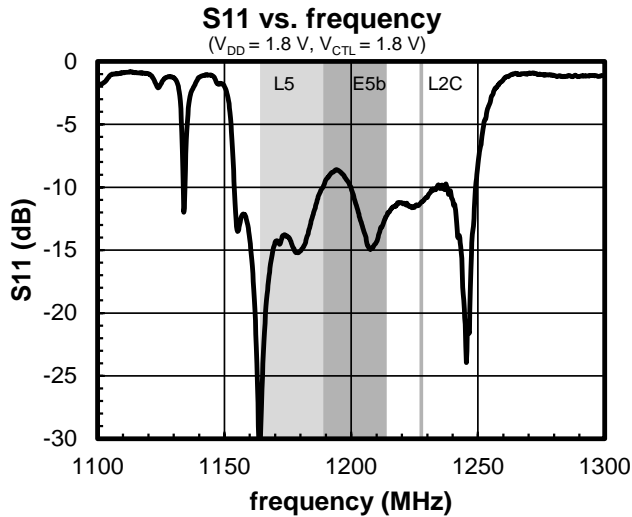

■ TYPICAL CHARACTERISTICS

Conditions: $V_{DD} = 1.8\text{ V}$, $V_{CTL} = 1.8\text{ V}$, $T_a = 25^\circ\text{C}$, $Z_s = Z_l = 50\ \Omega$, with application circuit

Note: Typical Characteristics are intended to be used as reference data; they are not guaranteed.

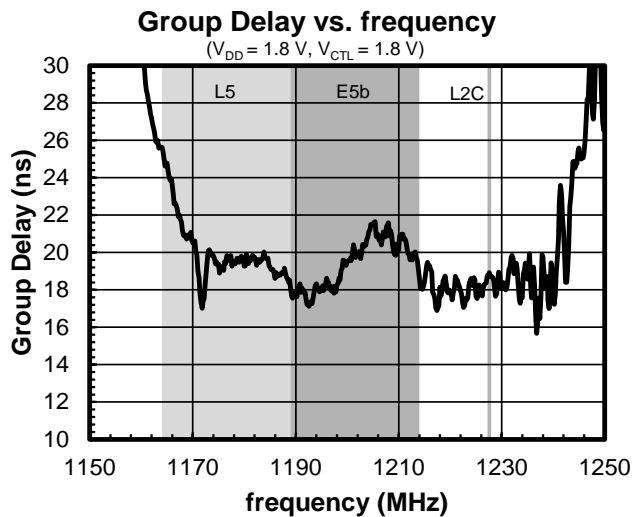
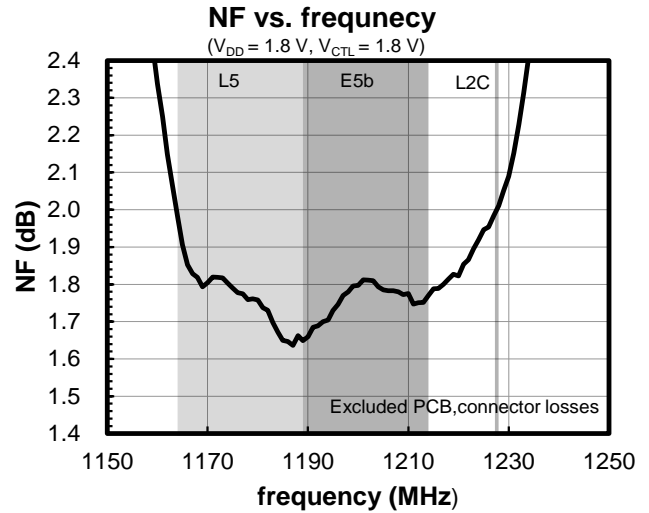
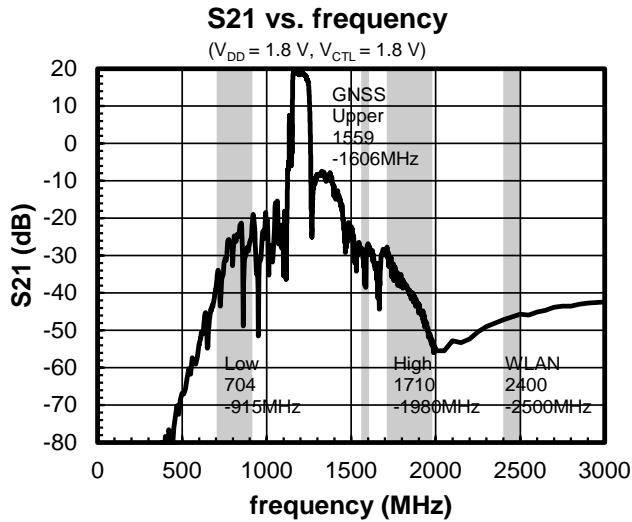

■ TYPICAL CHARACTERISTICS

Conditions: $V_{DD} = 1.8\text{ V}$, $V_{CTL} = 1.8\text{ V}$, $T_a = 25^\circ\text{C}$, $Z_s = Z_l = 50\ \Omega$, with application circuit

Note: Typical Characteristics are intended to be used as reference data; they are not guaranteed.

Pout, I_{DD} vs. Pin

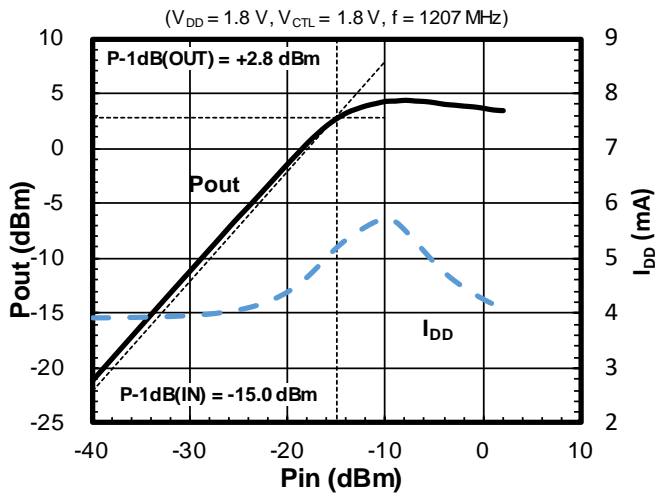

Gain, I_{DD} vs. Pin

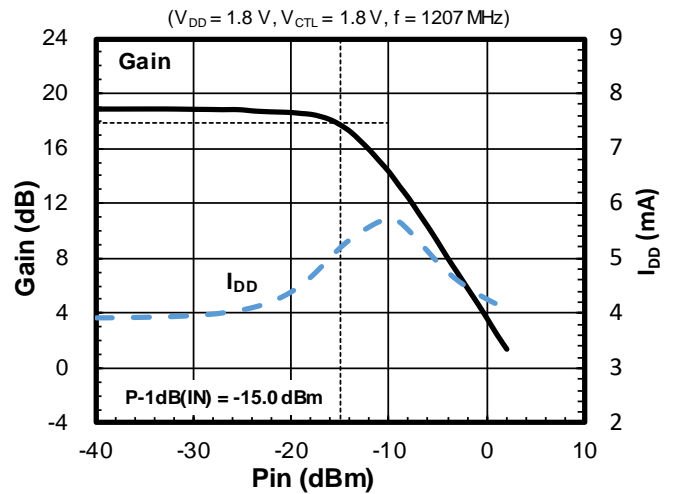

Pout, IM3 vs. Pin

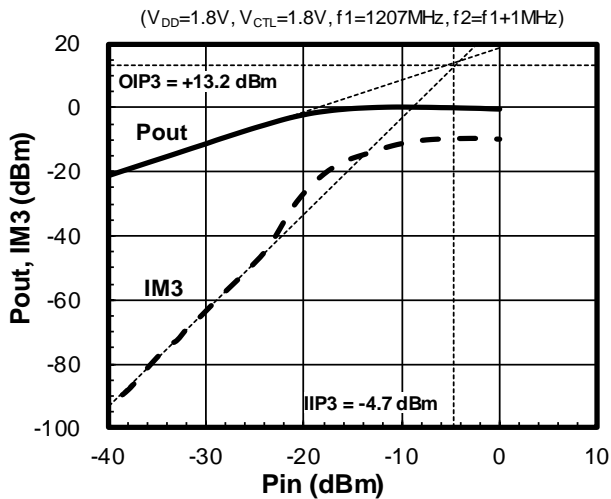

P-1dB(IN) vs. frequency

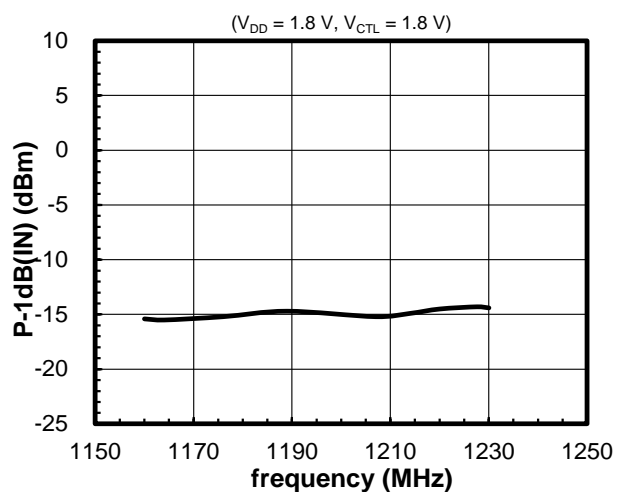

IIP3, OIP3 vs. frequency

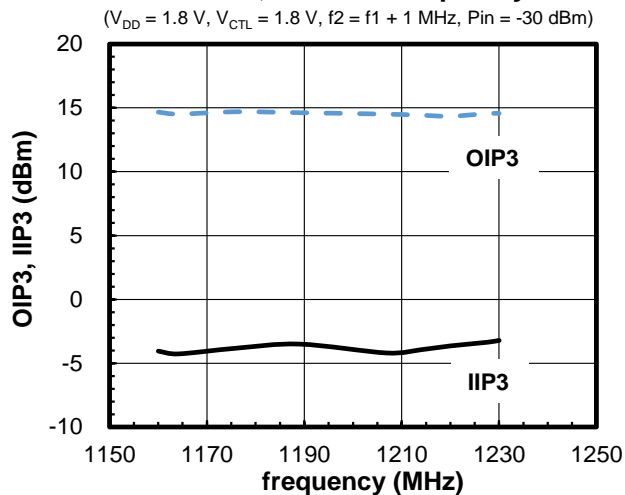

■ TYPICAL CHARACTERISTICS

Conditions: $V_{DD} = 2.8\text{ V}$, $V_{CTL} = 1.8\text{ V}$, $Z_s = Z_l = 50\ \Omega$, with application circuit

Note: Typical Characteristics are intended to be used as reference data; they are not guaranteed.

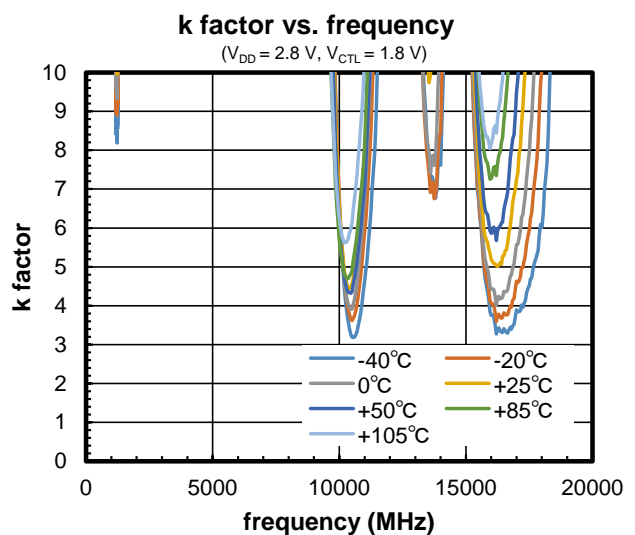
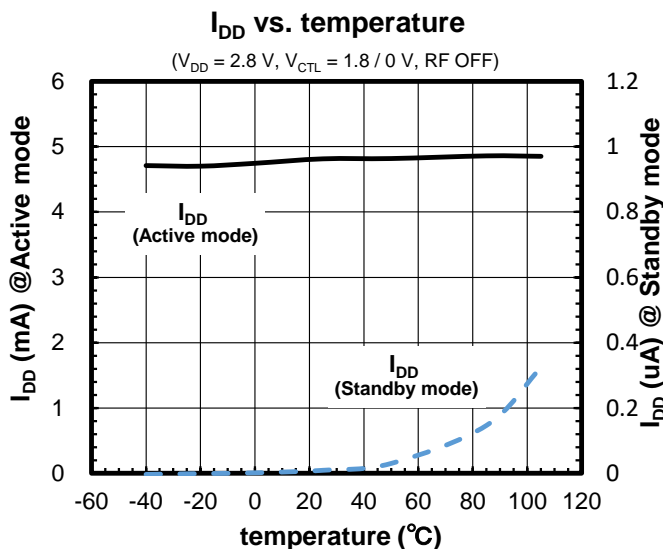
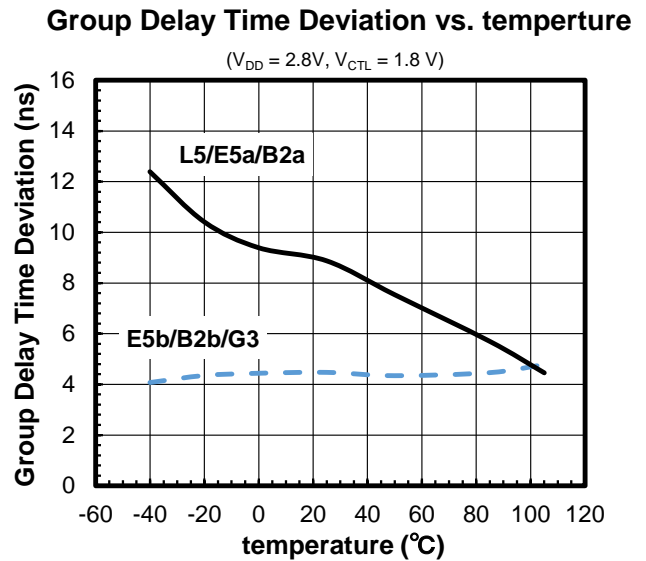
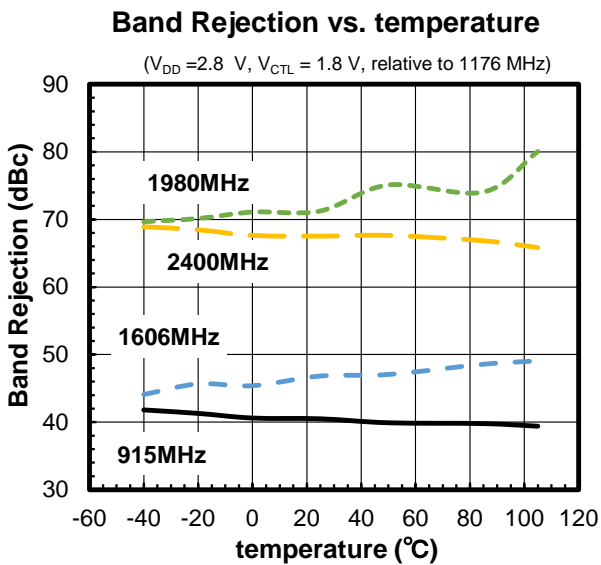
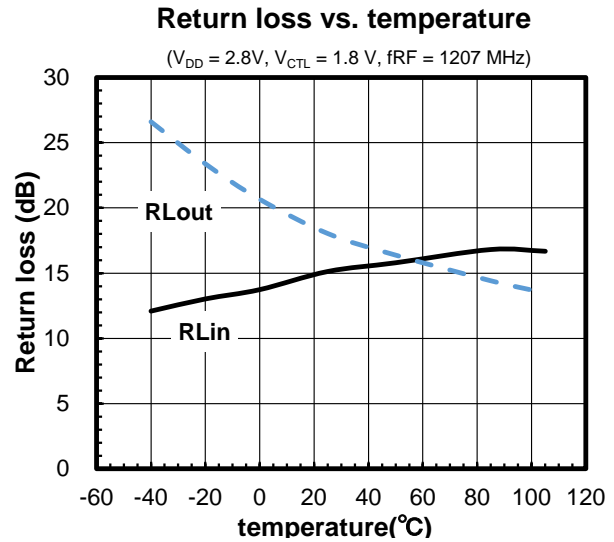
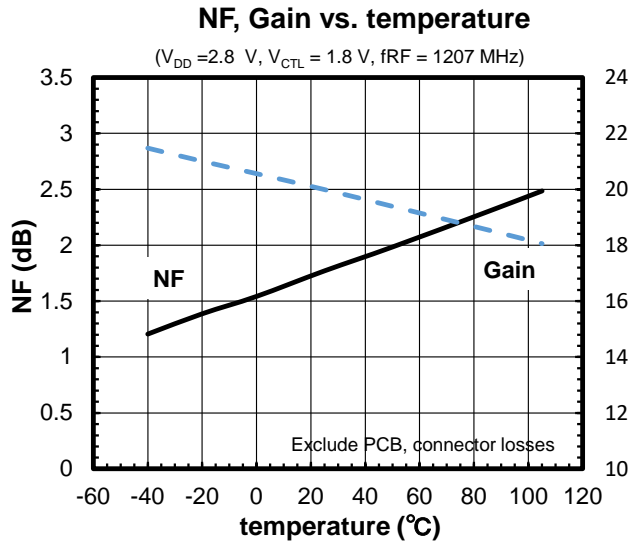

■ TYPICAL CHARACTERISTICS

Conditions: $V_{DD} = 2.8\text{ V}$, $V_{CTL} = 1.8\text{ V}$, $Z_s = Z_l = 50\ \Omega$, with application circuit

Note: Typical Characteristics are intended to be used as reference data; they are not guaranteed.

P-1dB(IN) vs. temperature

($V_{DD} = 2.8\text{ V}$, $V_{CTL} = 1.8\text{ V}$)

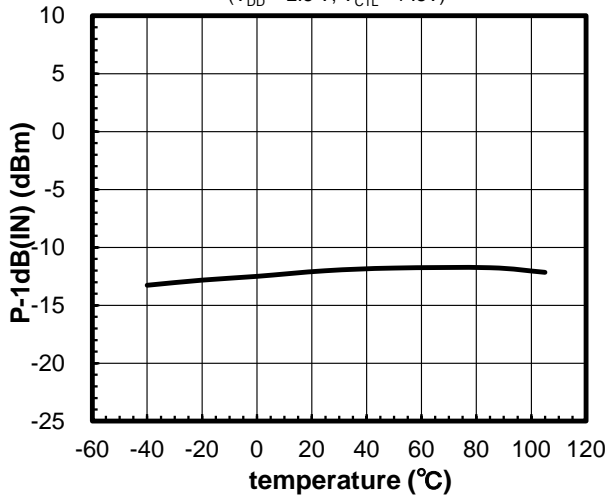

IIP3, OIP3 vs. temperature

($V_{DD} = 2.8\text{ V}$, $V_{CTL} = 1.8\text{ V}$, $f_1 = 1207\text{ MHz}$, $f_2 = f_1 + 1\text{ MHz}$, $P_{in} = -30\text{ dBm}$)

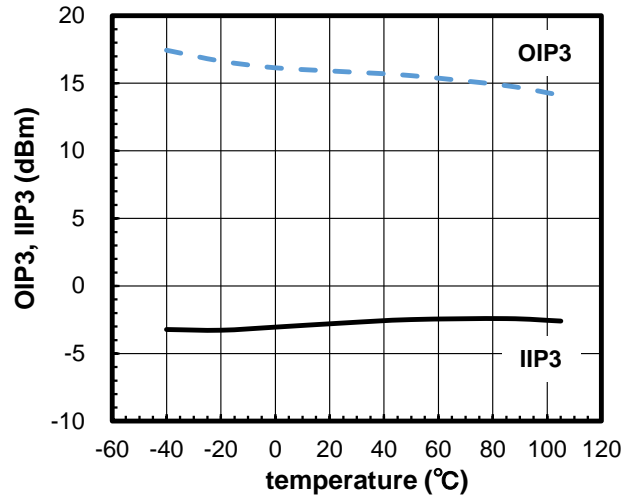

■ TYPICAL CHARACTERISTICS

Conditions: $V_{CTL} = 1.8\text{ V}$, $T_a = 25^\circ\text{C}$, $Z_s = Z_l = 50\ \Omega$, with application circuit

Note: Typical Characteristics are intended to be used as reference data; they are not guaranteed.

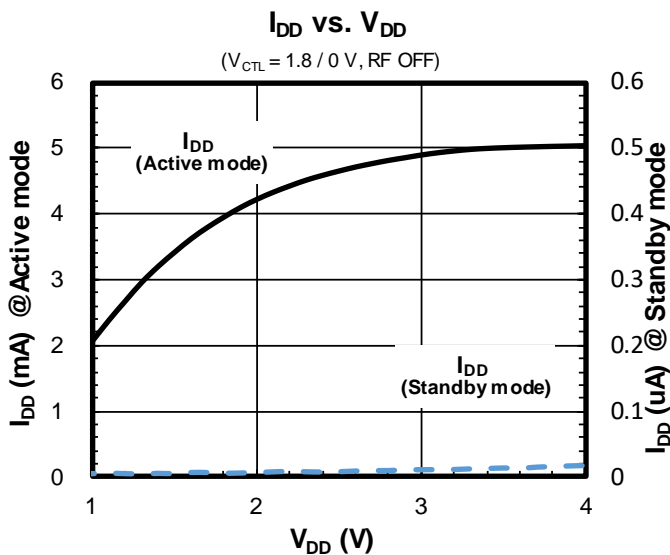
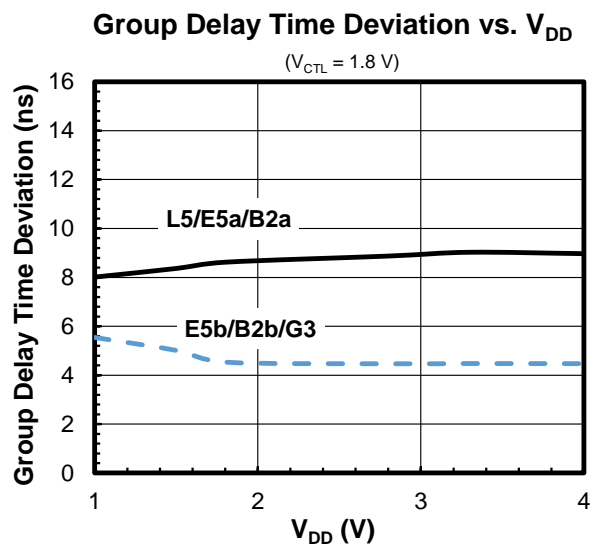
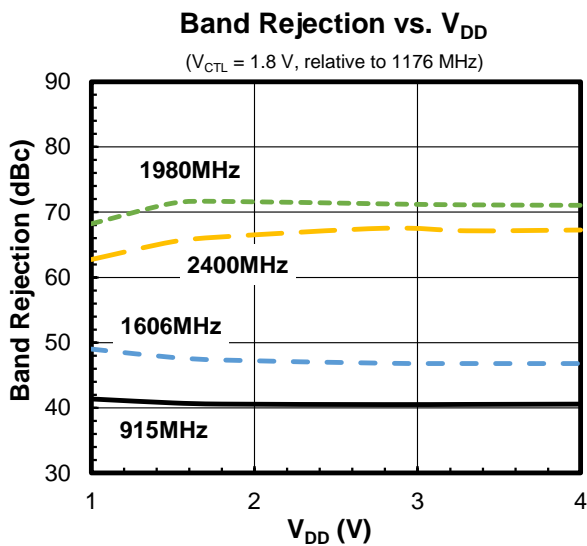
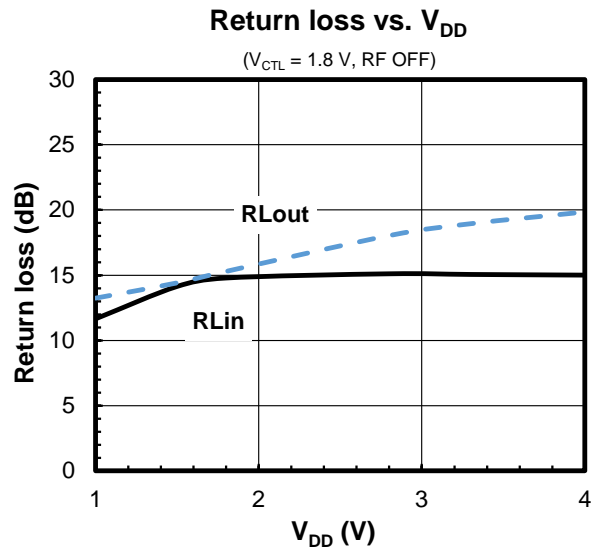
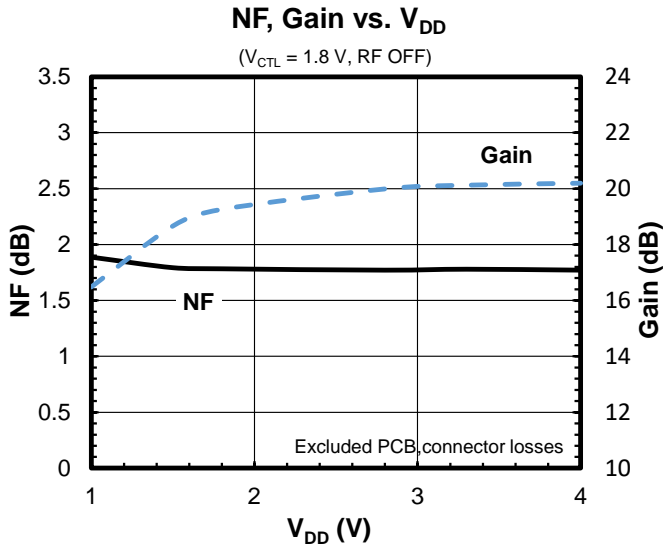

■ TYPICAL CHARACTERISTICS

Conditions: $V_{CTL} = 1.8\text{ V}$, $T_a = 25^\circ\text{C}$, $Z_s = Z_l = 50\ \Omega$, with application circuit

Note: Typical Characteristics are intended to be used as reference data; they are not guaranteed.

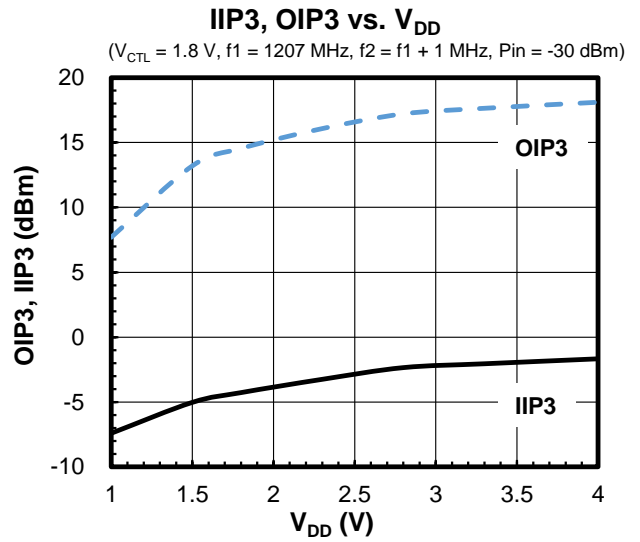
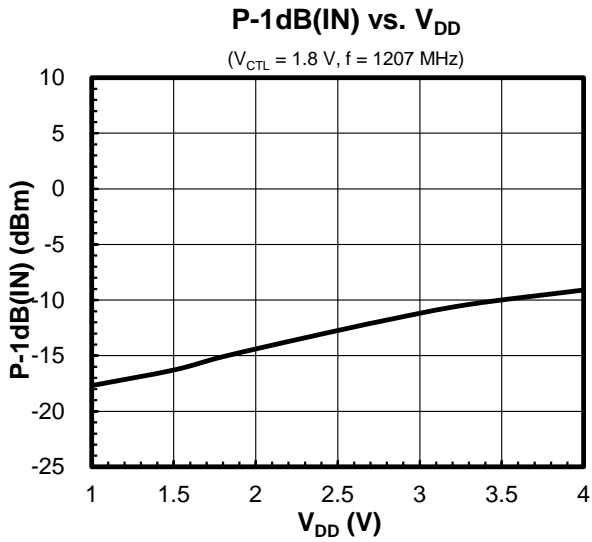

■ APPLICATION CIRCUIT

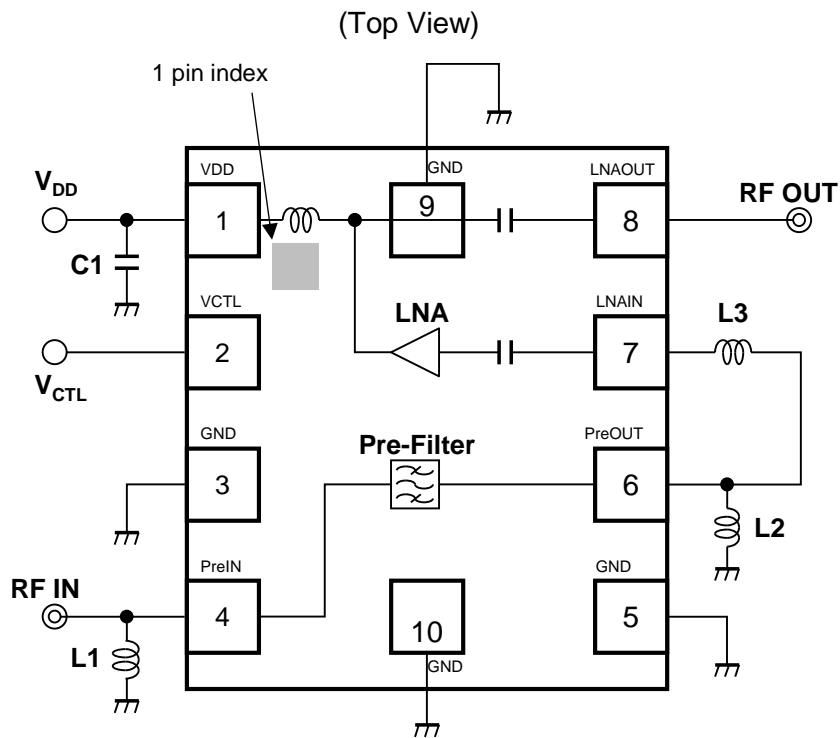

NJG1186PJL Application Circuit

<PARTS LIST>

Part ID	Value	Notes
L1	8.7 nH	LQW15AN_00 series (MURATA)
L2	8.7 nH	LQW15AN_00 series (MURATA)
L3	20 nH	LQW15AN_00 series (MURATA)
C1	1000 pF	GRM03 series (MURATA)

■ APPLICATION NOTES

● Evaluation Board / PCB Layout

(Top View)

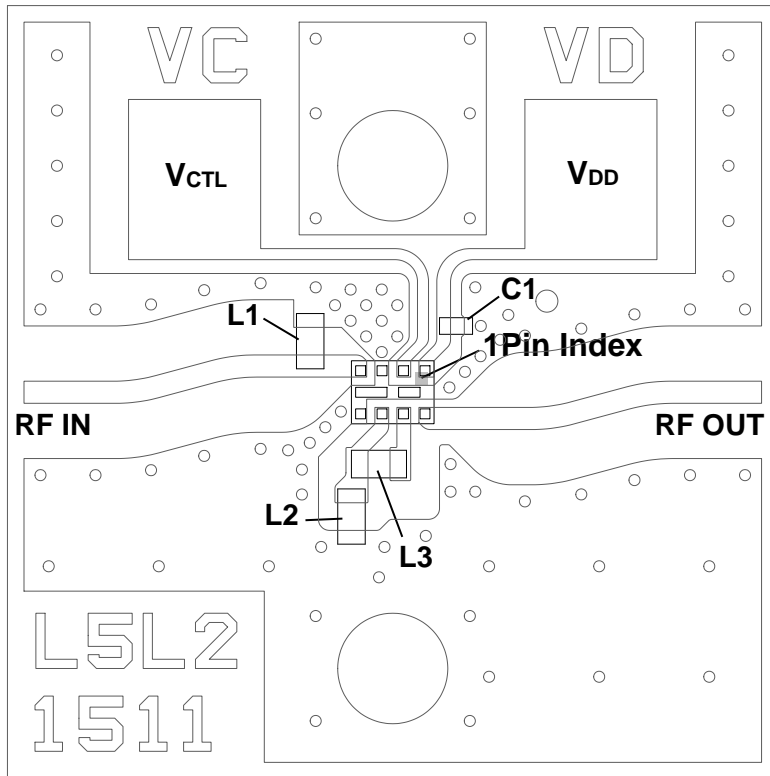

PCB

Substrate: FR-4

Thickness: 0.2 mm

Microstrip line width: 0.4 mm ($Z_0 = 50 \Omega$)

Size: 14.0 mm x 14.0 mm

<PCB LAYOUT GUIDELINE>

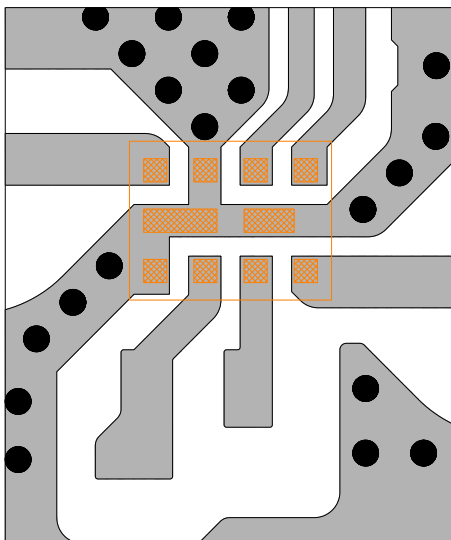

■ PCB

▨ PKG Terminal

□ PKG Outline

● GND Via Hole

Diameter = 0.2 mm

PRECAUTIONS

- Please layout ground pattern under this FEM in order not to couple with RFIN and RFOUT terminal.
- All external parts should be placed as close as possible to the FEM.
- For good RF performance, all GND terminals must be connected to PCB ground plane of substrate, and via-holes for GND should be placed near the FEM.

● NF MEASUREMENT BLOCK DIAGRAM

Measuring instruments

NF Analyzer : Keysight N8973A

Noise Source : Keysight N4000A

Setting the NF analyzer

Measurement mode form

Device under test : Amplifier

System downconverter : off

Mode setup form

Sideband : LSB

Averages : 8

Average mode : Point

Bandwidth : 4MHz

Loss comp : off

Tcold : setting the temperature of noise source (Auto)

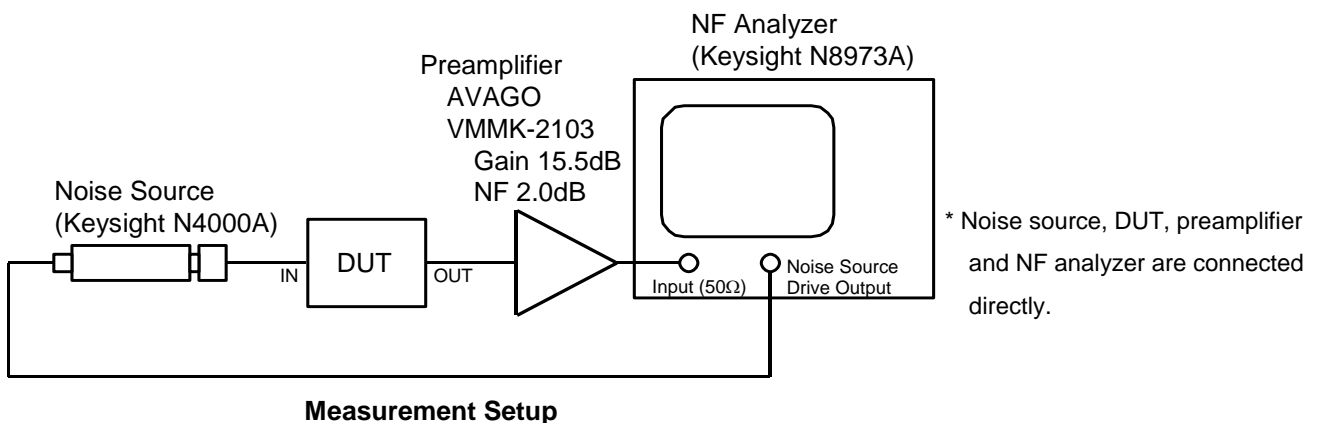
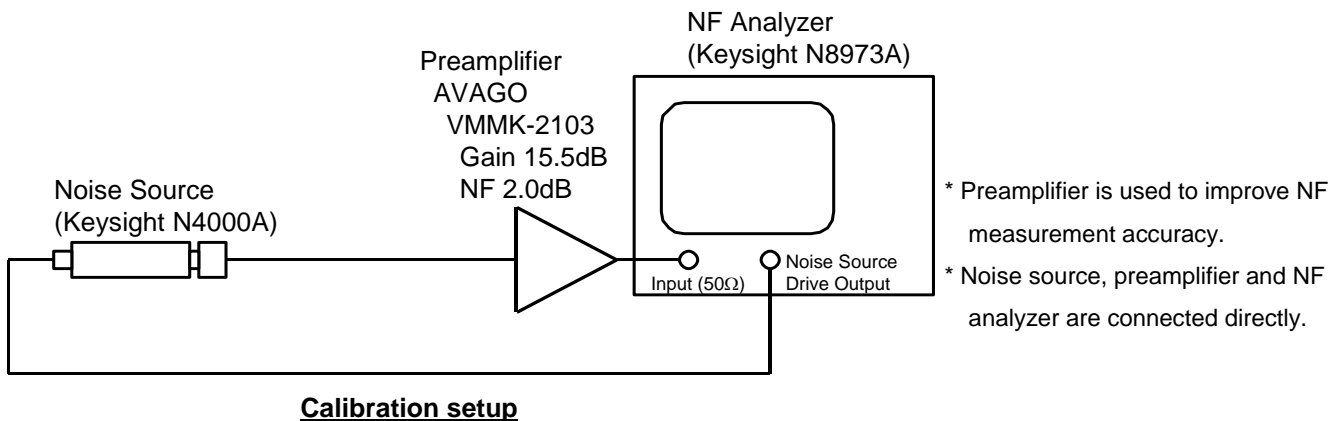

■ REVISION HISTORY

Date	Revision	Changes
4.26, 2022	Ver. 1.0	Initial release

■ PACKAGE DIMENSIONS



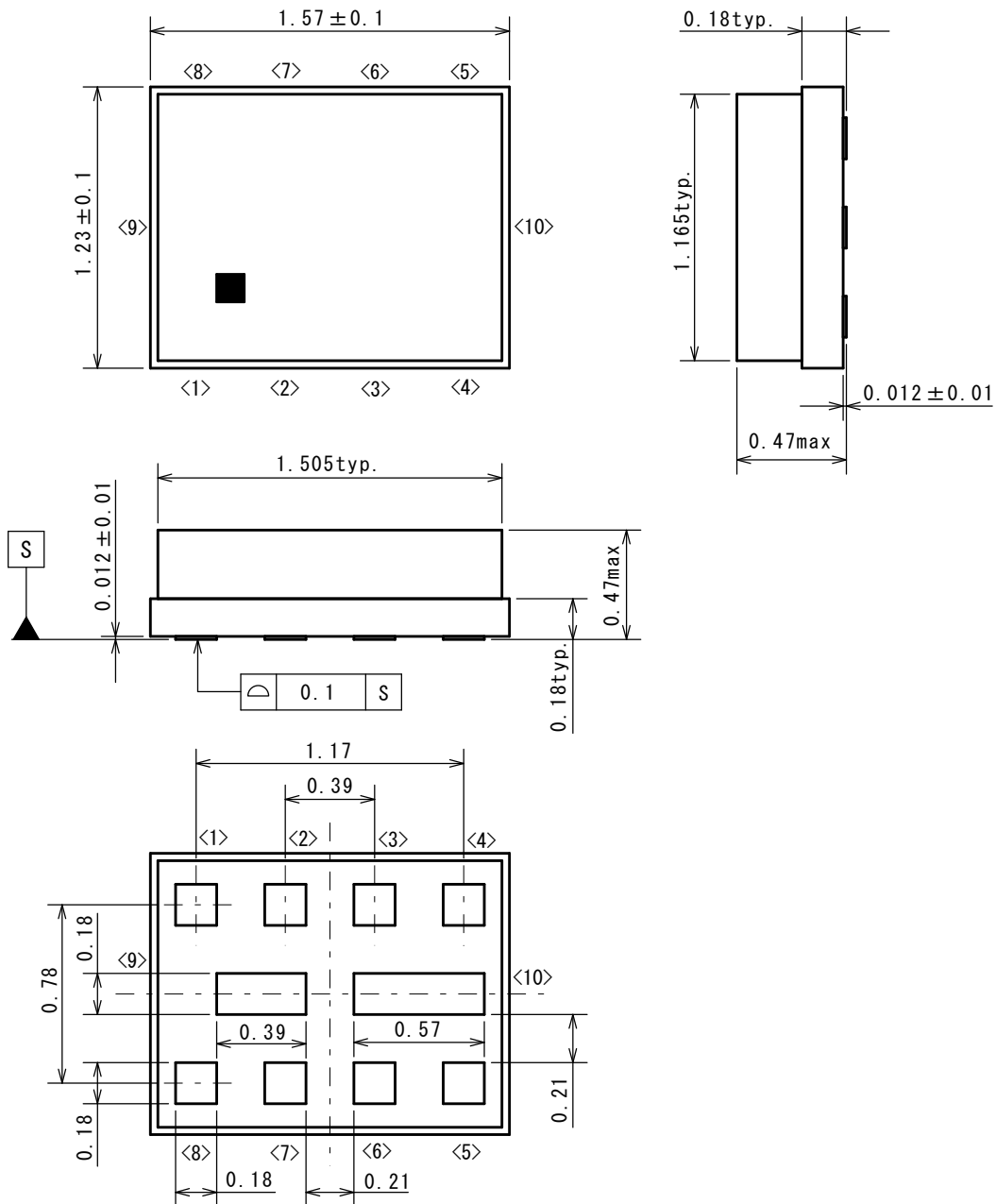

UNIT: mm

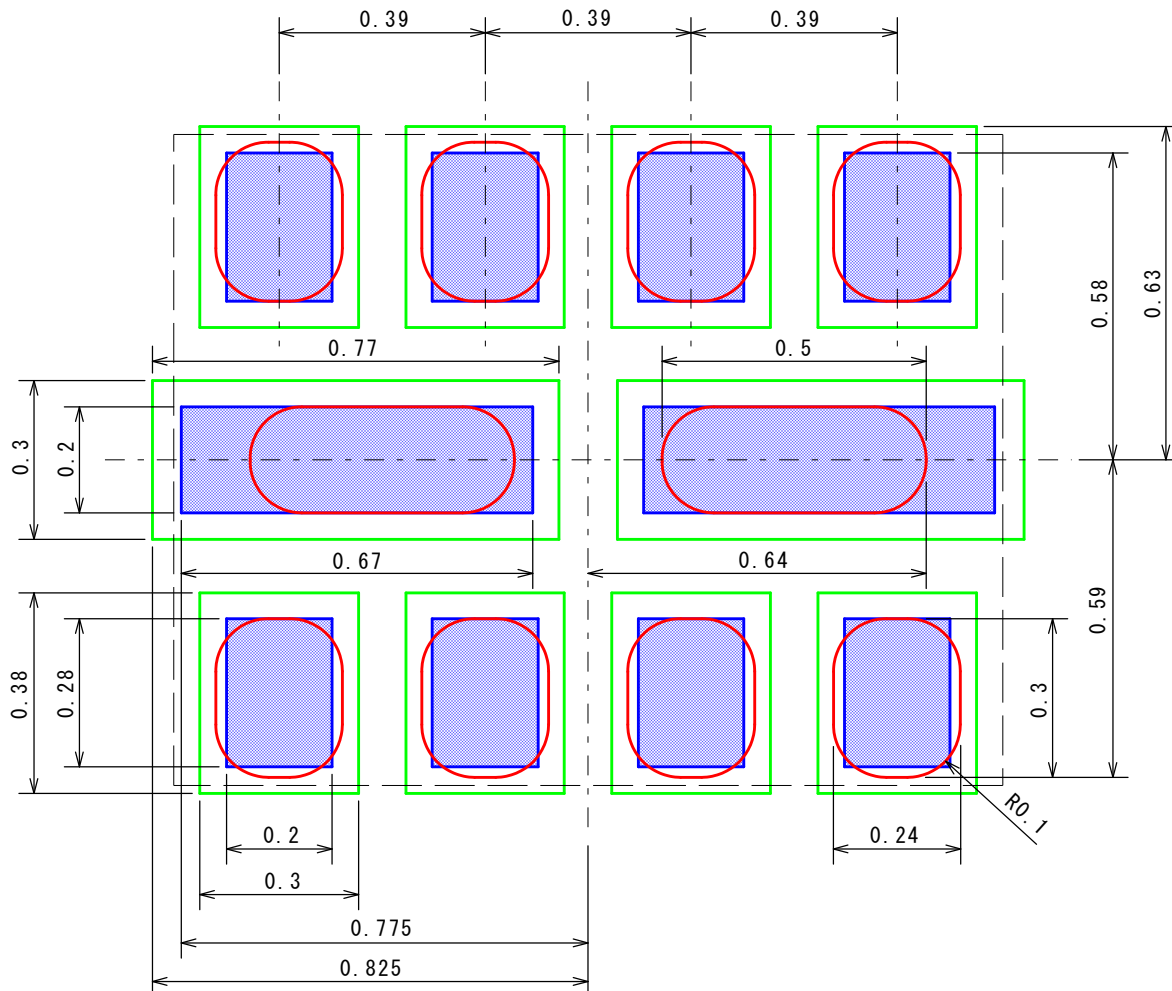

■ EXAMPLE OF SOLDER PADS DIMENSIONS

UNIT: mm



-  : Land
-  : Mask (Open area) Metal mask thickness : 100 μ m
-  : Resist (Open area)
-  : Package outline

Nisshinbo Micro Devices Inc.

HFFP10-JL

Ver. PI-HFFP10-JL-E-A

■ PACKING SPEC

UNIT: mm

TAPING DIMENSIONS

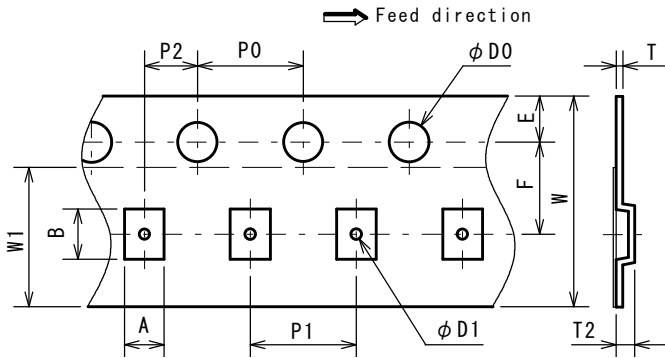

SYMBOL	DIMENSION	REMARKS
A	1.5±0.1	BOTTOM DIMENSION
B	1.85±0.1	BOTTOM DIMENSION
D0	1.5 ^{+0.1} ₀	
D1	0.5±0.05	
E	1.75±0.1	
F	3.5±0.05	
P0	4.0±0.1	
P1	4.0±0.1	
P2	2.0±0.05	
T	0.25±0.05	
T2	0.7±0.1	
W	8.0±0.2	
W1	5.3±0.2	THICKNESS100μm max

REEL DIMENSIONS

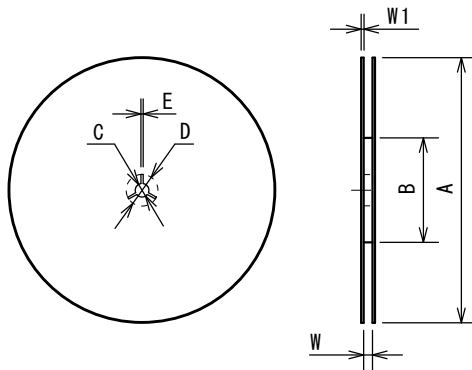

SYMBOL	DIMENSION
A	φ 180 ⁰ _{-1.5}
B	φ 66±0.5
C	φ 13±0.2
D	φ 21±0.8
E	2±0.5
W	9 ⁺¹ ₀
W1	1.2

TAPING STATE

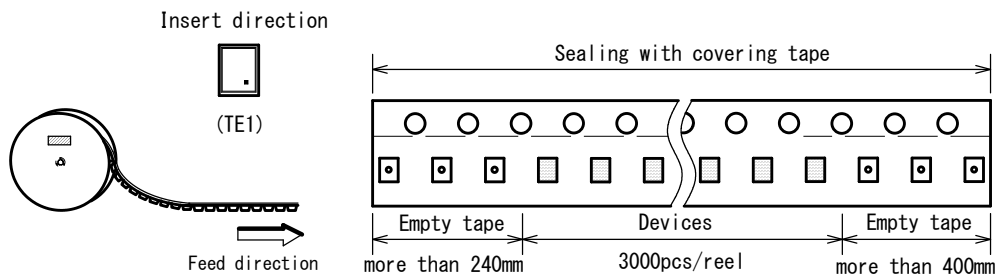

PACKING STATE

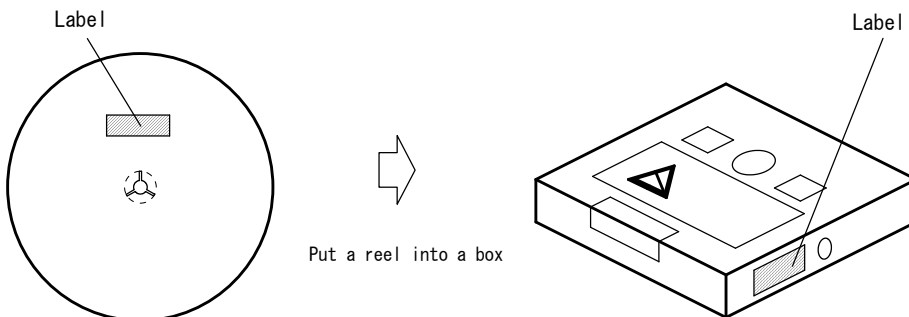

1. The products and the product specifications described in this document are subject to change or discontinuation of production without notice for reasons such as improvement. Therefore, before deciding to use the products, please refer to our sales representatives for the latest information thereon.
2. The materials in this document may not be copied or otherwise reproduced in whole or in part without the prior written consent of us.
3. This product and any technical information relating thereto are subject to complementary export controls (so-called KNOW controls) under the Foreign Exchange and Foreign Trade Law, and related politics ministerial ordinance of the law. (Note that the complementary export controls are inapplicable to any application-specific products, except rockets and pilotless aircraft, that are insusceptible to design or program changes.) Accordingly, when exporting or carrying abroad this product, follow the Foreign Exchange and Foreign Trade Control Law and its related regulations with respect to the complementary export controls.
4. The technical information described in this document shows typical characteristics of and example application circuits for the products. The release of such information is not to be construed as a warranty of or a grant of license under our or any third party's intellectual property rights or any other rights.
5. The products listed in this document are intended and designed for use as general electronic components in standard applications (office equipment, telecommunication equipment, measuring instruments, consumer electronic products, amusement equipment etc.). Those customers intending to use a product in an application requiring extreme quality and reliability, for example, in a highly specific application where the failure or misoperation of the product could result in human injury or death should first contact us.
 - Aerospace Equipment
 - Equipment Used in the Deep Sea
 - Power Generator Control Equipment (Nuclear, steam, hydraulic, etc.)
 - Life Maintenance Medical Equipment
 - Fire Alarms / Intruder Detectors
 - Vehicle Control Equipment (automotive, airplane, railroad, ship, etc.)
 - Various Safety Devices
 - Traffic control system
 - Combustion equipment

In case your company desires to use this product for any applications other than general electronic equipment mentioned above, make sure to contact our company in advance. Note that the important requirements mentioned in this section are not applicable to cases where operation requirements such as application conditions are confirmed by our company in writing after consultation with your company.
6. We are making our continuous effort to improve the quality and reliability of our products, but electronic device products are likely to fail with certain probability. In order to prevent any injury to persons or damages to property resulting from such failure, customers should be careful enough to incorporate safety measures in their design, such as redundancy feature, fire containment feature and fail-safe feature. We do not assume any liability or responsibility for any loss or damage arising from misuse or inappropriate use of the products. We do not assume any liability or responsibility for any loss or damage arising from misuse or inappropriate use of the products.
7. The products have been designed and tested to function within controlled environmental conditions. Do not use products under conditions that deviate from methods or applications specified in this datasheet. Failure to employ the products in the proper applications can lead to deterioration, destruction or failure of the products. We shall not be responsible for any bodily injury, fires or accident, property damage or any consequential damages resulting from misuse or misapplication of the products.
8. Quality Warranty
 - 8-1. Quality Warranty Period

In the case of a product purchased through an authorized distributor or directly from us, the warranty period for this product shall be one(1) year after delivery to your company. For defective products that occurred during this period, we will take the quality warranty measures described in section 8-2.

However, if there is an agreement on the warranty period in the basic transaction agreement, quality assurance agreement, delivery specifications, etc., it shall be followed.
 - 8-2. Quality Warranty Remedies

When it has been proved defective due to manufacturing factors as a result of defect analysis by us, we will either deliver a substitute for the defective product or refund the purchase price of the defective product.

Note that such delivery or refund is sole and exclusive remedies to your company for the defective product.
 - 8-3. Remedies after Quality Warranty Period

With respect to any defect of this product found after the quality warranty period, the defect will be analyzed by us. On the basis of the defect analysis results, the scope and amounts of damages shall be determined by mutual agreement of both parties. Then we will deal with upper limit in Section 8-2. This provision is not intended to limit any legal rights of your company.
9. Anti-radiation design is not implemented in the products described in this document.
10. The X-ray exposure can influence functions and characteristics of the products. Confirm the product functions and characteristics in the evaluation stage.
11. WLCSP products should be used in light shielded environments. The light exposure can influence functions and characteristics of the products under operation or storage.
12. Warning for handling Gallium and Arsenic (GaAs) products (Applying to GaAs MMIC, Photo Reflector). These products use Gallium (Ga) and Arsenic (As) which are specified as poisonous chemicals by law. For the prevention of a hazard, do not burn, destroy, or process chemically to make them as gas or power. When the product is disposed of, please follow the related regulation and do not mix this with general industrial waste or household waste.
13. Front end module product is hollow seal package type, and it is with the structure susceptible to stress from the outside. Therefore, note the following in relation to the contents, after conducting an evaluation, please use.
 - 13-1. After mounting this product, to implement the potting and transfer molding, please the confirmation of resistance to temperature changes and shrinkage stress involved in the molding.
 - 13-2. When mounted on the product, collet diameter please use more than 1mmφ. In addition, the value of static load is recommended mounting less than 5N.
 - 13-3. For dynamic load at the time of mounting, please use it after confirming in consideration of the contact area /speed /load.
14. Please contact our sales representatives should you have any questions or comments concerning the products or the technical information.



Nisshinbo Micro Devices Inc.

Official website

<https://www.nisshinbo-microdevices.co.jp/en/>

Purchase information

<https://www.nisshinbo-microdevices.co.jp/en/buy/>