

Silicon Carbide (SiC) MOSFET – EliteSiC, 14 mohm, 1200 V, M3P, D2PAK-7L

NTBG014N120M3P

Features

- Typ. $R_{DS(on)}$ = 14 m Ω
- Low Switching Losses (Typ. E_{ON} 1331 μ J at 74 A, 800 V)
- 100% Avalanche Tested

Typical Applications

- Solar Inverters
- Electric Vehicle Charging Stations
- UPS (Uninterruptible Power Supplies)
- Energy Storage Systems
- SMPS (Switch Mode Power Supplies)

MAXIMUM RATINGS ($T_J = 25^\circ\text{C}$ unless otherwise noted)

Symbol	Parameter		Value	Unit	
V_{DSS}	Drain-to-Source Voltage		1200	V	
V_{GS}	Gate-to-Source Voltage		-10 +22	V	
V_{GSop}	Recommended Operation Values of Gate-Source Voltage	$T_C < 175^\circ\text{C}$	-3/+18	V	
I_D	Continuous Drain Current $R_{\theta JC}$ (Note 2)	Steady State	$T_C = 25^\circ\text{C}$	104	A
P_D	Power Dissipation $R_{\theta JC}$ (Note 2)			454	W
I_D	Continuous Drain Current $R_{\theta JC}$ (Note 1, 2)	Steady State	$T_C = 100^\circ\text{C}$	73	A
P_D	Power Dissipation $R_{\theta JC}$ (Note 1, 2)			227	W
I_{DM}	Pulsed Drain Current (Note 3)	$T_A = 25^\circ\text{C}$	257	A	
T_J, T_{STG}	Operating Junction and Storage Temperature		-55 to 175	$^\circ\text{C}$	
I_S	Source Current (Body Diode) $T_C = 25^\circ\text{C}, V_{GS} = -3\text{ V}$		92	A	
E_{AS}	Single Pulse Drain-to-Source Avalanche Energy (Note 5) ($I_L = 28.9\text{ A}_{pk}, L = 1\text{ mH}$) (Note 4)		418	mJ	
T_L	Maximum Lead Temperature for Soldering, 1/8" from Case for 10 seconds		245	$^\circ\text{C}$	

Stresses exceeding those listed in the Maximum Ratings table may damage the device. If any of these limits are exceeded, device functionality should not be assumed, damage may occur and reliability may be affected.

1. Surface mounted on a FR-4 board using 1 in² pad of 2 oz copper.
2. The entire application environment impacts the thermal resistance values shown, they are not constants and are only valid for the particular conditions noted.
3. Repetitive rating, limited by max junction temperature.
4. Peak current might be limited by transconductance.
5. E_{AS} of 418 mJ is based on starting $T_J = 25^\circ\text{C}$; $L = 1\text{ mH}$, $I_{AS} = 28.9\text{ A}$, $V_{DD} = 100\text{ V}$, $V_{GS} = 18\text{ V}$.

$V_{(BR)DSS}$	$R_{DS(ON)}\text{ MAX}$	$I_D\text{ MAX}$
1200 V	20 m Ω @ 18 V	104 A

N-CHANNEL MOSFET

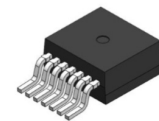
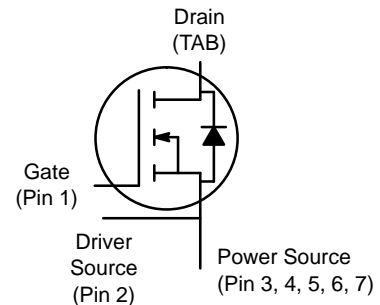

D2PAK-7L
CASE 418BJ

MARKING DIAGRAM

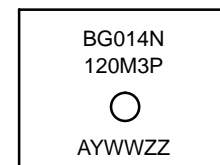

- A = Assembly Location
- Y = Year
- WW = Work Week
- ZZ = Lot Traceability
- BG014N120M3P = Specific Device Code

ORDERING INFORMATION

Device	Package	Shipping†
NTBG014N120M3P	D2PAK-7L	800 / Tape & Reel

†For information on tape and reel specifications, including part orientation and tape sizes, please refer to our Tape and Reel Packaging Specification Brochure, [BRD8011/D](#).

NTBG014N120M3P

THERMAL CHARACTERISTICS

Symbol	Parameter	Typ	Max	Unit
$R_{\theta JC}$	Thermal Resistance Junction-to-Case (Note 2)	0.33	–	°C/W
$R_{\theta JA}$	Thermal Resistance Junction-to-Ambient (Note 1, 2)	–	40	°C/W

ELECTRICAL CHARACTERISTICS ($T_J = 25^\circ\text{C}$ unless otherwise noted)

Symbol	Parameter	Test Conditions	Min	Typ	Max	Unit
--------	-----------	-----------------	-----	-----	-----	------

OFF-STATE CHARACTERISTICS

$V_{(BR)DSS}$	Drain-to-Source Breakdown Voltage	$V_{GS} = 0\text{ V}, I_D = 1\text{ mA}$	1200			V
$V_{(BR)DSS} / T_J$	Drain-to-Source Breakdown Voltage Temperature Coefficient	$I_D = 1\text{ mA}$, refer to 25°C		0.3		mV/°C
I_{DSS}	Zero Gate Voltage Drain Current	$V_{GS} = 0\text{ V}, V_{DS} = 1200\text{ V}, T_J = 25^\circ\text{C}$			100	μA
I_{GSS}	Gate-to-Source Leakage Current	$V_{GS} = +22/-10\text{ V}, V_{DS} = 0\text{ V}$			± 1	μA

ON-STATE CHARACTERISTICS

$V_{GS(TH)}$	Gate Threshold Voltage	$V_{GS} = V_{DS}, I_D = 37\text{ mA}$	2.08	3.0	4.63	V
V_{GOP}	Recommended Gate Voltage		-3		+18	V
$R_{DS(on)}$	Drain-to-Source On Resistance	$V_{GS} = 18\text{ V}, I_D = 74\text{ A}, T_J = 25^\circ\text{C}$		14	20	m Ω
		$V_{GS} = 18\text{ V}, I_D = 74\text{ A}, T_J = 175^\circ\text{C}$		29		m Ω
		$V_{GS} = 15\text{ V}, I_D = 74\text{ A}, T_J = 25^\circ\text{C}$		16	27	m Ω
		$V_{GS} = 15\text{ V}, I_D = 74\text{ A}, T_J = 150^\circ\text{C}$		27		m Ω
g_{FS}	Forward Transconductance	$V_{DS} = 10\text{ V}, I_D = 74\text{ A}$		29		S

CHARGES, CAPACITANCES & GATE RESISTANCE

C_{ISS}	Input Capacitance	$V_{GS} = 0\text{ V}, f = 1\text{ MHz}, V_{DS} = 800\text{ V}$		6313		pF
C_{OSS}	Output Capacitance			259		
C_{RSS}	Reverse Transfer Capacitance			27		
$Q_{G(TOT)}$	Total Gate Charge	$V_{GS} = -3/18\text{ V}, V_{DS} = 800\text{ V}, I_D = 74\text{ A}$		337		nC
$Q_{G(TH)}$	Threshold Gate Charge			43		
Q_{GS}	Gate-to-Source Charge			78		
Q_{GD}	Gate-to-Drain Charge			98		
R_G	Gate Resistance	$f = 1\text{ MHz}$		1.4		Ω

SWITCHING CHARACTERISTICS

$t_{d(ON)}$	Turn-On Delay Time	$V_{GS} = -3/18\text{ V}, V_{DS} = 800\text{ V}, I_D = 74\text{ A}, R_G = 2\text{ }\Omega$ Inductive Load (Note 6)		24		ns
t_r	Rise Time			40		
$t_{d(OFF)}$	Turn-Off Delay Time			74		
t_f	Fall Time			14		
E_{ON}	Turn-On Switching Loss			1331		μJ
E_{OFF}	Turn-Off Switching Loss			620		
E_{TOT}	Total Switching Loss			1951		

NTBG014N120M3P

ELECTRICAL CHARACTERISTICS ($T_J = 25^\circ\text{C}$ unless otherwise noted) (continued)

Symbol	Parameter	Test Conditions	Min	Typ	Max	Unit
DRAIN-SOURCE DIODE CHARACTERISTICS						
I_{SD}	Continuous Drain-Source Diode Forward Current	$V_{GS} = -3\text{ V}$, $T_C = 25^\circ\text{C}$			92	A
I_{SDM}	Pulsed Drain-Source Diode Forward Current (Note 3)	$V_{GS} = -3\text{ V}$, $T_C = 25^\circ\text{C}$			257	A
V_{SD}	Forward Diode Voltage	$V_{GS} = -3\text{ V}$, $I_{SD} = 74\text{ A}$, $T_J = 25^\circ\text{C}$		5.1		V
t_{RR}	Reverse Recovery Time	$V_{GS} = -3/18\text{ V}$, $I_{SD} = 74\text{ A}$, $di_S/dt = 1000\text{ A}/\mu\text{s}$, V , $V_{DS} = 800\text{ V}$		37		ns
Q_{RR}	Reverse Recovery Charge			347		nC
E_{REC}	Reverse Recovery Energy			12		μJ
I_{RRM}	Peak Reverse Recovery Current			19		A
t_A	Charge Time			19		ns
t_B	Discharge Time			17		ns

Product parametric performance is indicated in the Electrical Characteristics for the listed test conditions, unless otherwise noted. Product performance may not be indicated by the Electrical Characteristics if operated under different conditions.

6. E_{ON}/E_{OFF} result is with body diode.

NTBG014N120M3P

TYPICAL CHARACTERISTICS

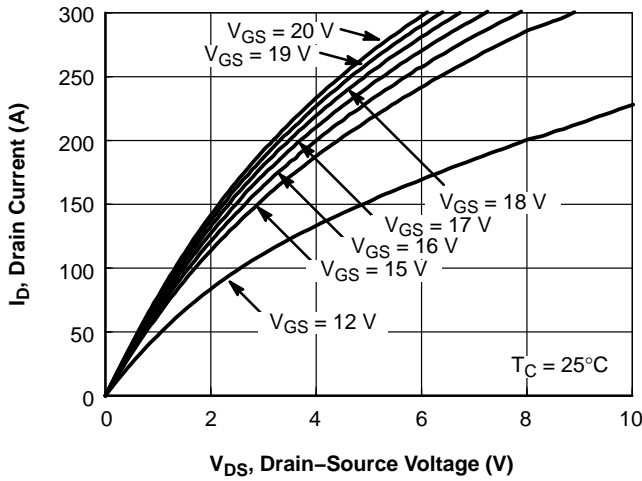

Figure 1. On-Region Characteristics

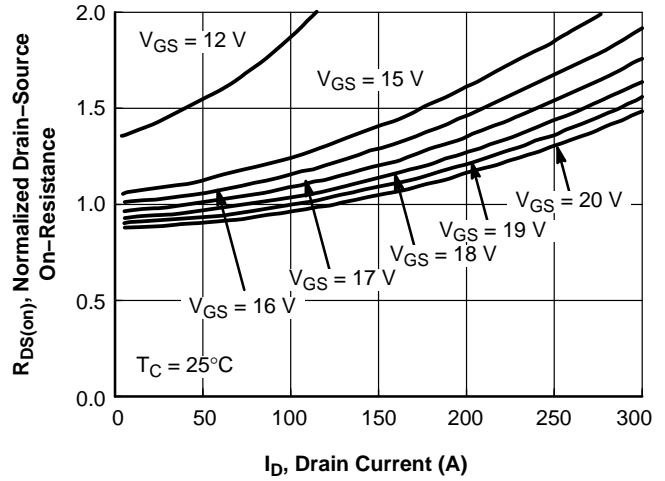

Figure 2. Normalized On-Resistance vs. Drain Current and Gate Voltage

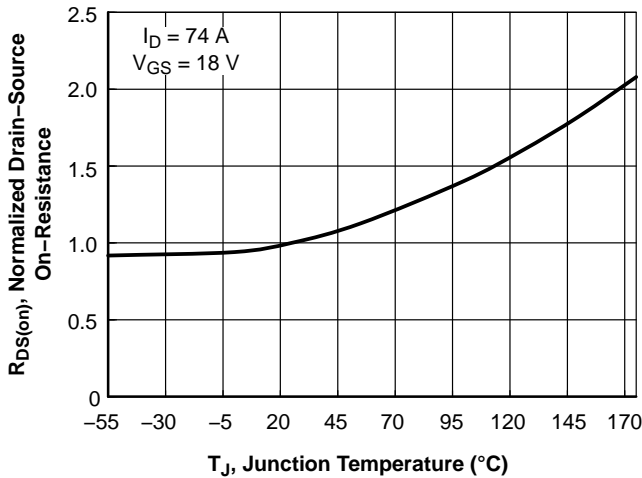

Figure 3. On-Resistance Variation with Temperature

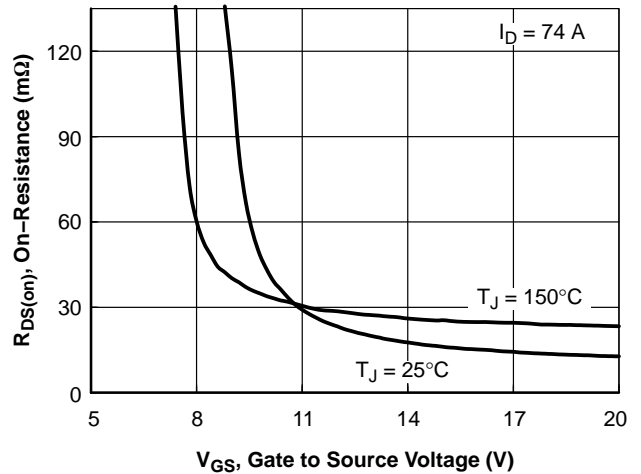

Figure 4. On-Resistance vs. Gate-to-Source Voltage

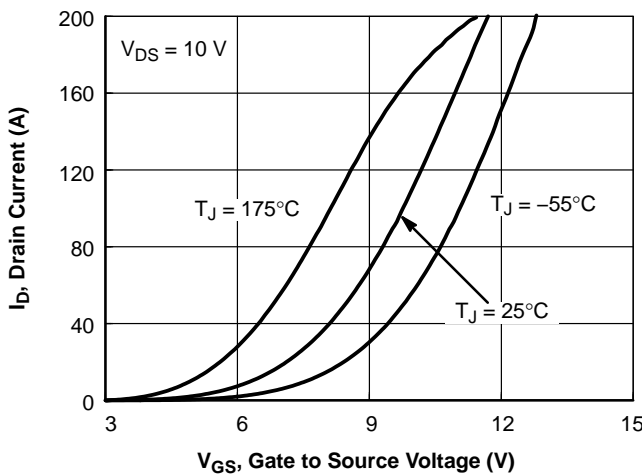

Figure 5. Transfer Characteristics

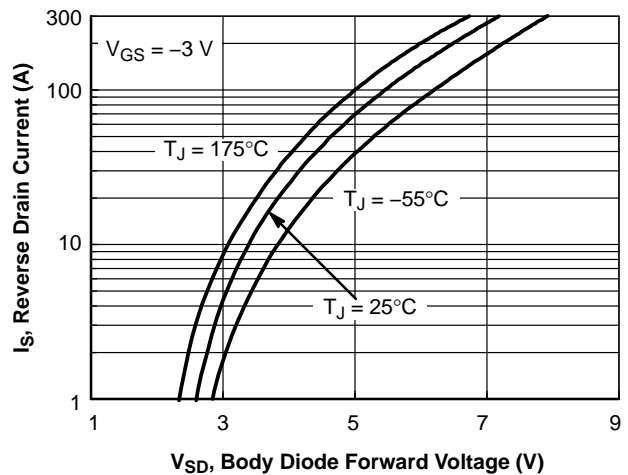

Figure 6. Diode Forward Voltage vs. Current

NTBG014N120M3P

TYPICAL CHARACTERISTICS (CONTINUED)

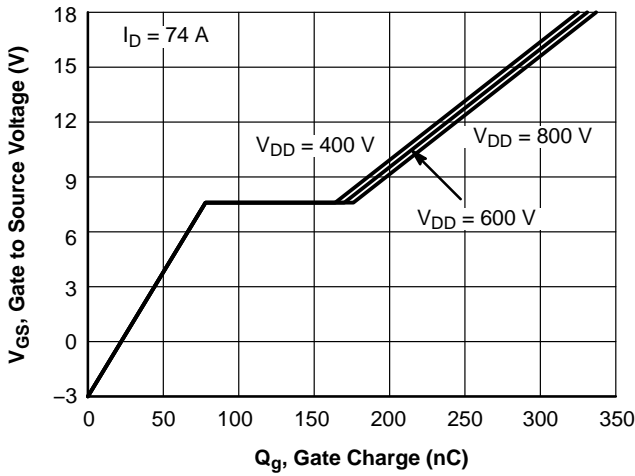

Figure 7. Gate-to-Source Voltage vs. Total Charge

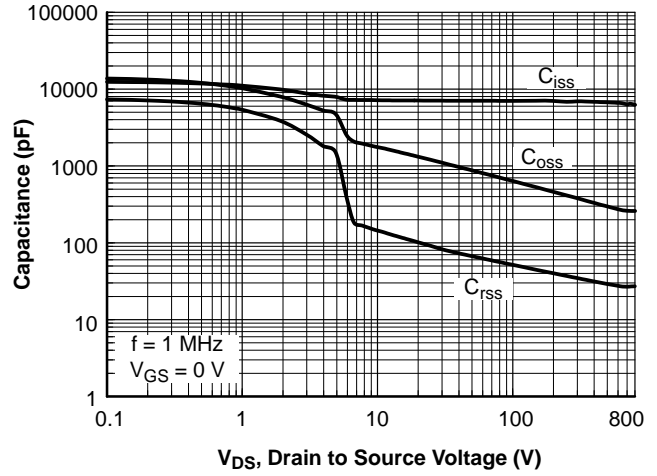

Figure 8. Capacitance vs. Drain to Source Voltage

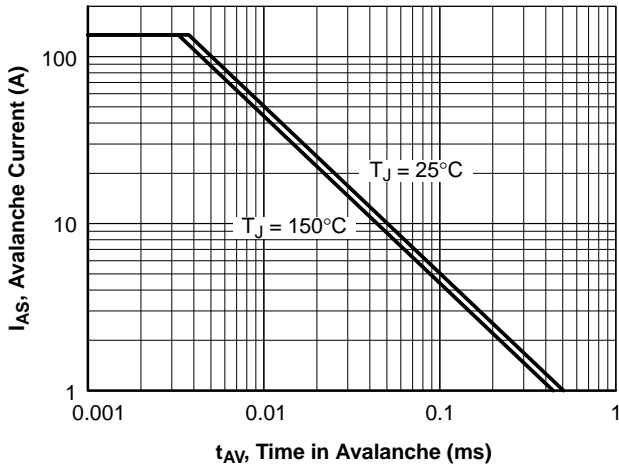

Figure 9. Unclamped Inductive Switching Capability

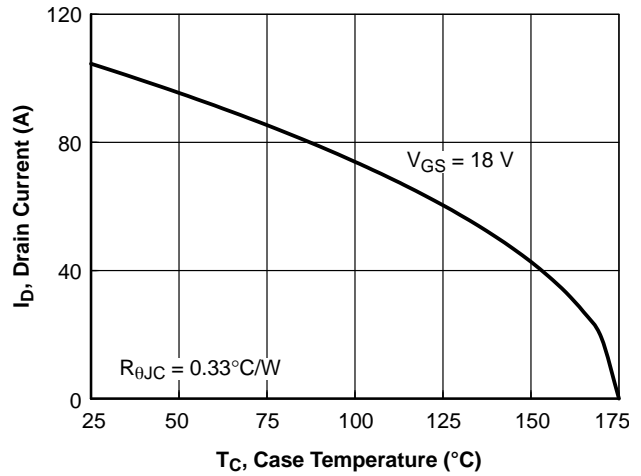

Figure 10. Maximum Continuous Drain Current vs. Case Temperature

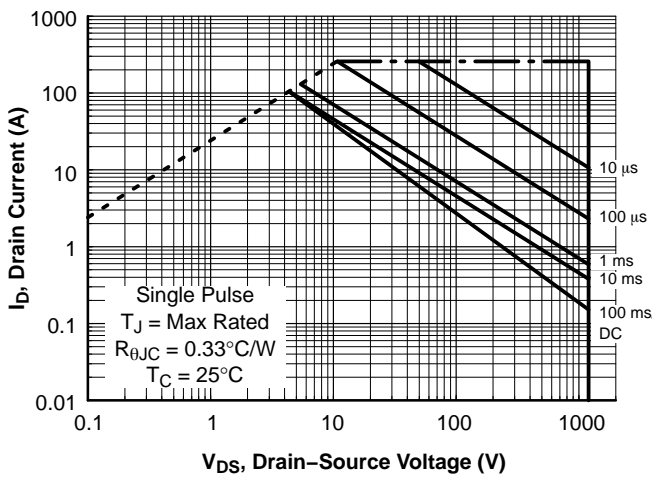

Figure 11. Safe Operating Area

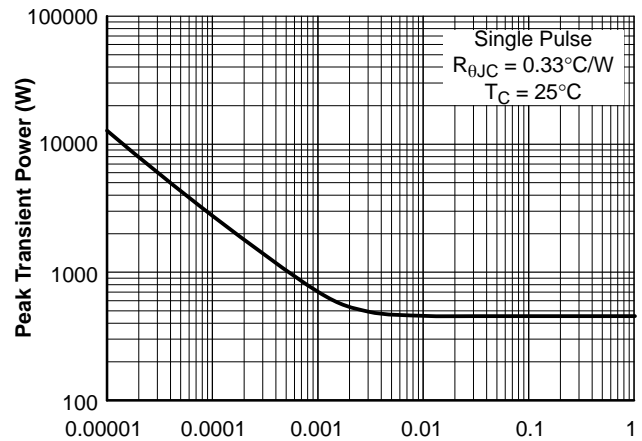

Figure 12. Single Pulse Maximum Power Dissipation

NTBG014N120M3P

TYPICAL CHARACTERISTICS (CONTINUED)

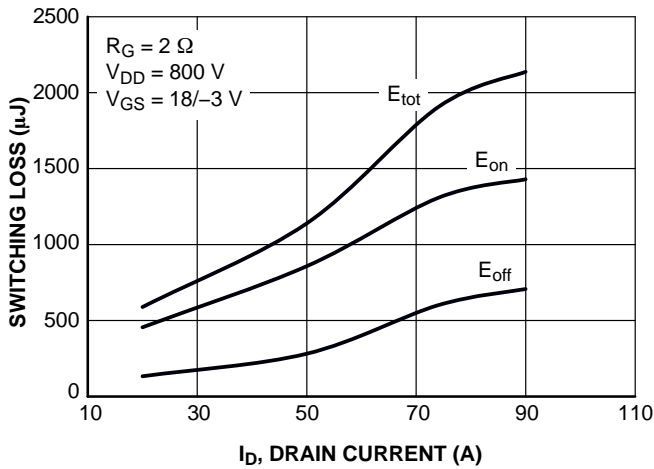

Figure 13. Switching Loss vs. Drain Current

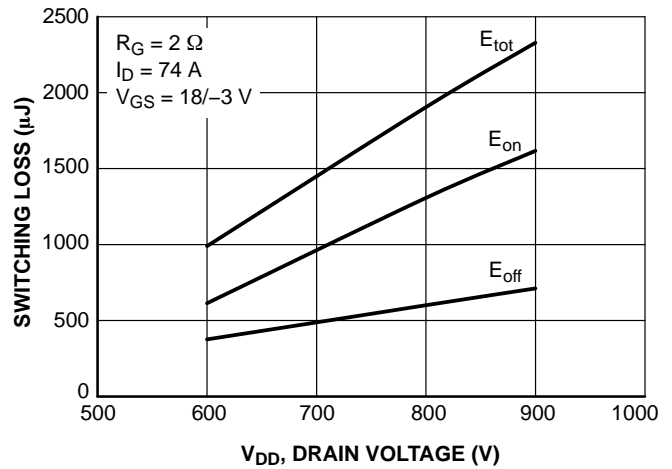

Figure 14. Switching Loss vs. Drain Voltage

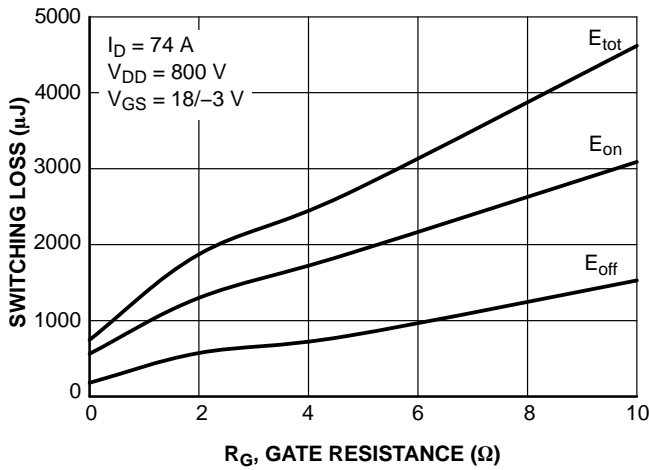

Figure 15. Switching Loss vs. Gate Resistance

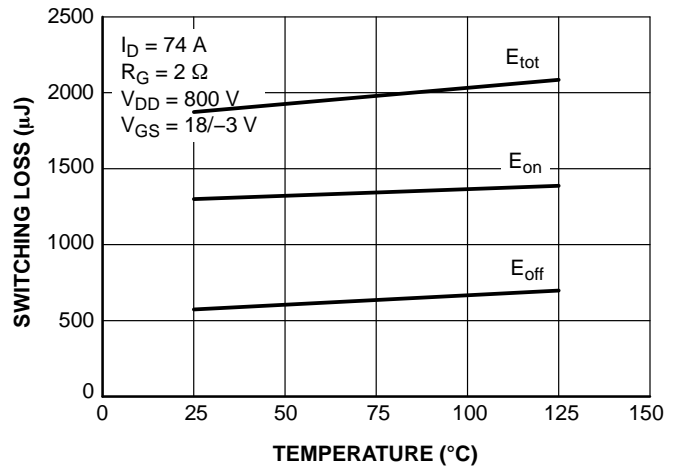

Figure 16. Switching Loss vs. Temperature

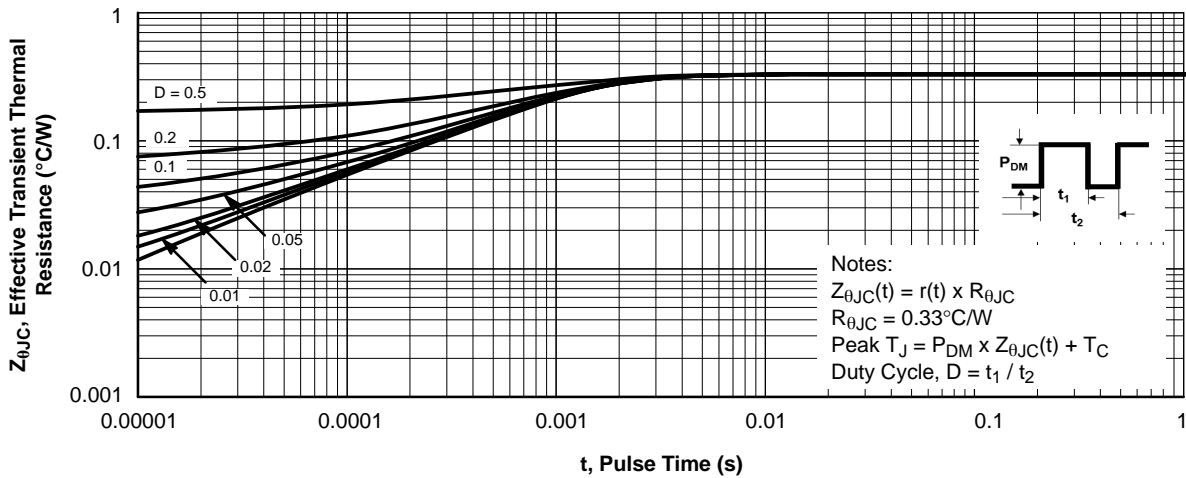
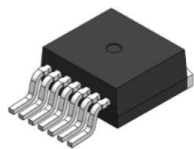

Figure 17. Junction-To-Case Transient Thermal Response Curve

MECHANICAL CASE OUTLINE PACKAGE DIMENSIONS



D²PAK7 (TO-263-7L HV) CASE 418BJ ISSUE B

DATE 16 AUG 2019

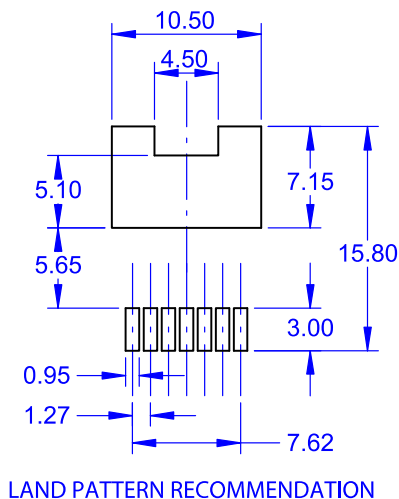
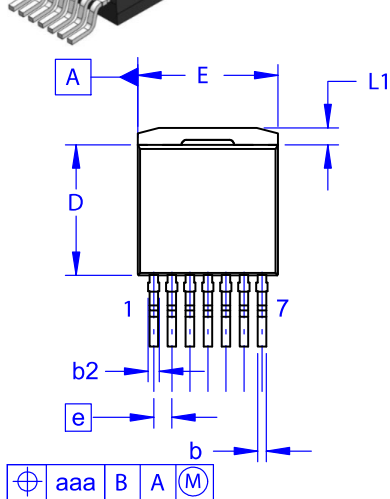

NOTES:

- A. PACKAGE CONFORMS TO JEDEC TO-263 VARIATION CB EXCEPT WHERE NOTED.
- B. ALL DIMENSIONS ARE IN MILLIMETERS.

- △ OUT OF JEDEC STANDARD VALUE.
- D. DIMENSION AND TOLERANCE AS PER ASME Y14.5-2009.
- E. DIMENSIONS ARE EXCLUSIVE OF BURRS, MOLD FLASH AND TIE BAR PROTRUSIONS.

DIM	MILLIMETERS		
	MIN	NOM	MAX
A	4.30	4.50	4.70
A1	0.00	0.10	0.20
b2	0.60	0.70	0.80
b	0.51	0.60	0.70
c	0.40	0.50	0.60
c2	1.20	1.30	1.40
D	9.00	9.20	9.40
D1	6.15	6.80	7.15
E	9.70	9.90	10.20
E1	7.15	7.65	8.15
e	~	1.27	~
H	15.10	15.40	15.70
L	2.44	2.64	2.84
L1	1.00	1.20	1.40
L3	~	0.25	~
aaa	~	~	0.25

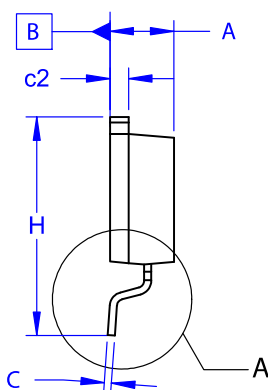
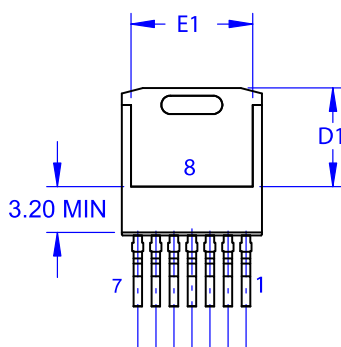

GENERIC MARKING DIAGRAM*



- XXXX = Specific Device Code
- A = Assembly Location
- Y = Year
- WW = Work Week
- G = Pb-Free Package

*This information is generic. Please refer to device data sheet for actual part marking. Pb-Free indicator, "G" or microdot "•", may or may not be present. Some products may not follow the Generic Marking.

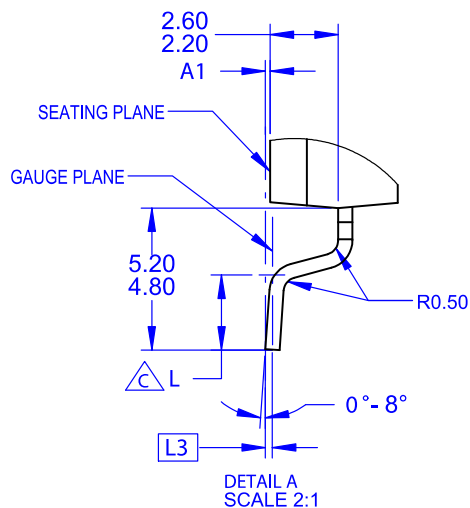

DOCUMENT NUMBER:	98AON84234G	Electronic versions are uncontrolled except when accessed directly from the Document Repository. Printed versions are uncontrolled except when stamped "CONTROLLED COPY" in red.
DESCRIPTION:	D²PAK7 (TO-263-7L HV)	PAGE 1 OF 1

onsemi and ONSEMI are trademarks of Semiconductor Components Industries, LLC dba onsemi or its subsidiaries in the United States and/or other countries. onsemi reserves the right to make changes without further notice to any products herein. onsemi makes no warranty, representation or guarantee regarding the suitability of its products for any particular purpose, nor does onsemi assume any liability arising out of the application or use of any product or circuit, and specifically disclaims any and all liability, including without limitation special, consequential or incidental damages. onsemi does not convey any license under its patent rights nor the rights of others.

onsemi, **Onsemi**, and other names, marks, and brands are registered and/or common law trademarks of Semiconductor Components Industries, LLC dba "**onsemi**" or its affiliates and/or subsidiaries in the United States and/or other countries. **onsemi** owns the rights to a number of patents, trademarks, copyrights, trade secrets, and other intellectual property. A listing of **onsemi**'s product/patent coverage may be accessed at www.onsemi.com/site/pdf/Patent-Marking.pdf. **onsemi** reserves the right to make changes at any time to any products or information herein, without notice. The information herein is provided "as-is" and **onsemi** makes no warranty, representation or guarantee regarding the accuracy of the information, product features, availability, functionality, or suitability of its products for any particular purpose, nor does **onsemi** assume any liability arising out of the application or use of any product or circuit, and specifically disclaims any and all liability, including without limitation special, consequential or incidental damages. Buyer is responsible for its products and applications using **onsemi** products, including compliance with all laws, regulations and safety requirements or standards, regardless of any support or applications information provided by **onsemi**. "Typical" parameters which may be provided in **onsemi** data sheets and/or specifications can and do vary in different applications and actual performance may vary over time. All operating parameters, including "Typicals" must be validated for each customer application by customer's technical experts. **onsemi** does not convey any license under any of its intellectual property rights nor the rights of others. **onsemi** products are not designed, intended, or authorized for use as a critical component in life support systems or any FDA Class 3 medical devices or medical devices with a same or similar classification in a foreign jurisdiction or any devices intended for implantation in the human body. Should Buyer purchase or use **onsemi** products for any such unintended or unauthorized application, Buyer shall indemnify and hold **onsemi** and its officers, employees, subsidiaries, affiliates, and distributors harmless against all claims, costs, damages, and expenses, and reasonable attorney fees arising out of, directly or indirectly, any claim of personal injury or death associated with such unintended or unauthorized use, even if such claim alleges that **onsemi** was negligent regarding the design or manufacture of the part. **onsemi** is an Equal Opportunity/Affirmative Action Employer. This literature is subject to all applicable copyright laws and is not for resale in any manner.

ADDITIONAL INFORMATION

TECHNICAL PUBLICATIONS:

Technical Library: www.onsemi.com/design/resources/technical-documentation
onsemi Website: www.onsemi.com

ONLINE SUPPORT: www.onsemi.com/support

For additional information, please contact your local Sales Representative at www.onsemi.com/support/sales