

# SiT5501

1 MHz – 60 MHz, Elite X™ Stratum 3E Precision Oscillator



## Description

The SiT5501 is a Stratum 3E MEMS precision oscillator optimized for  $\pm 10$  ppb stability from  $-40^{\circ}\text{C}$  to  $105^{\circ}\text{C}$ . Engineered for exceptional dynamic performance, it is ideal for replacing larger and less robust quartz OXOs. SiT5501 is uniquely positioned for high reliability telecom, edge networking, IEEE 1588 PTP, and optical transport applications.

Leveraging SiTime's unique DualMEMS® temperature sensing and TurboCompensation® technologies, the SiT5501 delivers the best dynamic performance for timing stability in the presence of environmental stressors such as air flow, temperature perturbation, vibration, shock, and magnetic interference. This device also integrates multiple on-chip regulators to filter power supply noise, eliminating the need for a dedicated external LDO.

The SiT5501 can be factory programmed for any combination of frequency, voltage, and pull range. Programmability enables designers to optimize clock configurations while eliminating long lead times and customization costs associated with quartz devices where each frequency is custom built.

Refer to [Manufacturing Guidelines](#) for proper reflow profile and PCB cleaning recommendations to ensure best performance.

## Features

- Any frequency from 1 MHz to 60 MHz in 1 Hz steps
- Factory programmable options for low lead time
- Best dynamic stability under airflow, thermal shock
  - $\pm 10$  ppb stability over temperature
  - $-40^{\circ}\text{C}$  to  $105^{\circ}\text{C}$  operating temperature range
  - $\pm 0.3$  ppb/ $^{\circ}\text{C}$  typical frequency slope ( $\Delta F/\Delta T$ )
  - $1.5\text{e-}11$  ADEV at 10 second averaging time
- Digital frequency control up to  $\pm 3200$  ppm
- No activity dips or micro jumps
- Resistant to shock, vibration and board bending
- On-chip regulators eliminate external LDOs
- 2.5 V, 2.8 V, 3.0 V and 3.3 V supply voltage
- LVCMOS or clipped sinewave output
- RoHS and REACH compliant
- Pb-free, Halogen-free, Antimony-free
- 7.0 mm x 5.0 mm ceramic package
- [Contact SiTime](#) for tighter stability, wider temperature, and alternate package options

## Applications

- 4G/5G radio, Small cell
- IEEE1588/SyncE boundary and grandmaster clocks
- Carrier-grade routers and switches
- Optical transport – SONET/SDH, OTN, Stratum 3E
- DOCSIS 3.x remote PHY
- GPS disciplined oscillators
- Precision GNSS systems
- Test and measurement





Order samples



Buy at SiTimeDirect



Green solutions



Lifetime warranty

## Block Diagram

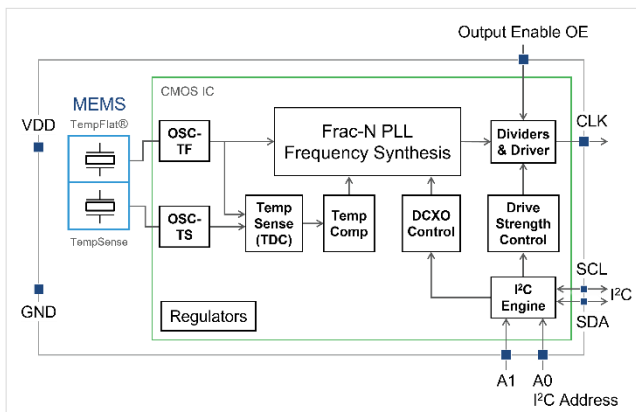

Figure 1. SiT5501 Block Diagram

## 7.0 mm x 5.0 mm Package Pinout

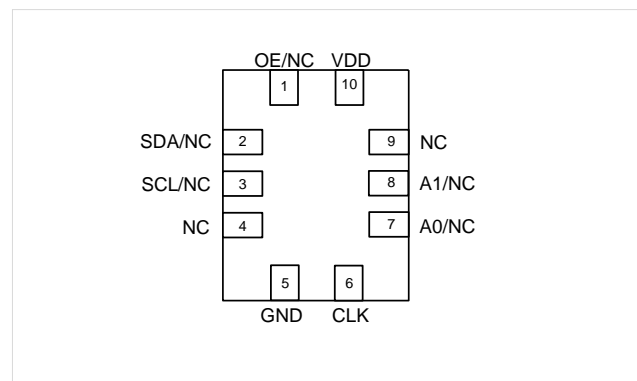
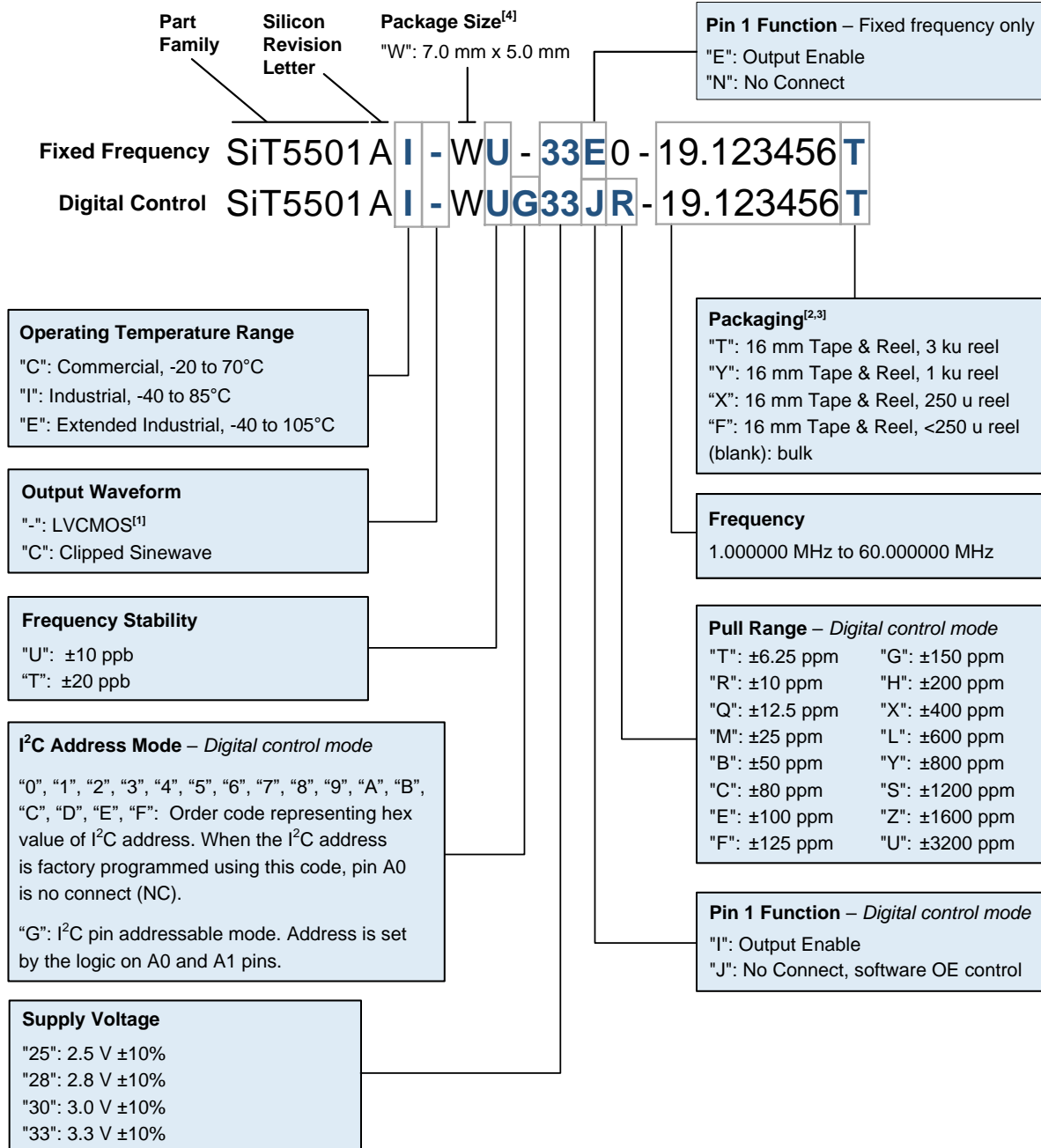

Figure 2. Pin Assignments (Top view)

## Ordering Information

The part number guide illustrated below is for reference only, in which boxes identify order codes having more than one option. To customize and build an exact part number, use the SiTime [Part Number Generator](#). To validate the part number, use the SiTime [Part Number Decoder](#).



**Notes:**

- "-" corresponds to the default rise/fall time for LVCMOS output as specified in Table 1 (Electrical Characteristics). [Contact SiTime](#) for other rise/fall time options for best EMI or driving multiple loads. For differential outputs, [contact SiTime](#).
- Bulk is available for sampling only.
- "F" packaging option has a minimum limit of 10 units.
- [Contact SiTime](#) for alternate package options.

## Table Of Contents

Description .....	1
Features.....	1
Applications .....	1
Block Diagram .....	1
7.0 mm x 5.0 mm Package Pinout .....	1
Ordering Information.....	2
Electrical Characteristics.....	4
Device Configurations and Pin-outs.....	8
Pin-out Top Views.....	8
Waveforms.....	9
Timing Diagrams.....	10
Stability Diagrams.....	10
Typical Performance Plots .....	11
Architecture Overview.....	14
Output Frequency and Format.....	14
Output Frequency Tuning.....	14
Pin 1 Configuration (OE, VC, or NC) .....	15
Device Configurations.....	15
TCXO Configuration .....	15
Dimensions and Patterns.....	16
Revision History.....	18
DCTCXO Device Configuration .....	20
DCTCXO-Specific Design Considerations .....	21
Pull Range and Absolute Pull Range.....	21
Output Frequency.....	22
I <sup>2</sup> C Control Registers .....	24
Register Descriptions.....	24
Register Address: 0x00. Digital Frequency Control Least Significant Word (LSW) .....	24
Register Address: 0x01. OE Control, Digital Frequency Control Most Significant Word (MSW).....	25
Register Address: 0x02. DIGITAL PULL RANGE CONTROL <sup>[15]</sup> .....	26
Serial Interface Configuration Description .....	27
Serial Signal Format .....	27
Parallel Signal Format .....	28
Parallel Data Format.....	28
I <sup>2</sup> C Timing Specification.....	30
I <sup>2</sup> C Device Address Modes.....	31
Schematic Example .....	32

## Electrical Characteristics

All Min and Max limits are specified over temperature and rated operating voltage with 15 pF output load unless otherwise stated. Typical values are at 25°C and 3.3 V Vdd.

**Table 1. Output Characteristics**

Parameters	Symbol	Min.	Typ.	Max.	Unit	Condition
<b>Frequency Coverage</b>						
Nominal Output Frequency Range	F_nom	1	–	60	MHz	Contact SiTime for higher frequency options
<b>Temperature Range</b>						
Operating Temperature Range	T_oper	-20	–	+70	°C	Commercial, ambient temperature
		-40	–	+85	°C	Industrial, ambient temperature
		-40	–	+105	°C	Extended industrial, ambient temperature
<b>Frequency Stability – Stratum 3E Grade</b>						
Frequency Stability over Temperature	F_stab	–	–	±10	ppb	Over operating temperature range (T_oper); referenced to (max frequency + min frequency)/2 over the temperature range.
Initial Tolerance	F_init	–	–	±0.1	ppm	Initial frequency at 25°C at 48 hours after 2 reflows. Contact SiTime for lower initial tolerance options.
Supply Voltage Sensitivity	F_Vdd	–	±0.5	±0.7	ppb	Over operating temperature range (T_oper); Vdd ±5%
Output Load Sensitivity	F_load	–	±0.1	±0.2	ppb	Over operating temperature (T_oper); LVCMOS output, 15 pF ±10%. Clipped sinewave, 10 kΩ    10 pF ±10%
Frequency vs. Temperature Slope	ΔF/ΔT	–	±0.3	±0.5	ppb/°C	0.5°C/min temperature ramp rate, over operating temperature (T_oper)
Dynamic Frequency Change during Temperature Ramp	F_dynamic	–	±0.003	±0.004	ppb/s	0.5°C/min temperature ramp rate, over operating temperature (T_oper)
Hysteresis Over Temperature	F_hys	–	±0.8	±2	ppb	0.5°C/min ramp rate, defined as ±ΔF/2, over operating temperature (T_oper)
One-Day Aging	F_1d	–	±0.2	±0.5	ppb	At 85°C, after 30-days of continued operation. Aging is measured with respect to day 31
One-Year Aging	F_1y	–	–	±80	ppb	At 85°C, after 2-days of continued operation. Aging is measured with respect to day 3. Contact SiTime for aging optimized devices.
20-Year Aging	F_20y	–	–	±150	ppb	
20-Year Total Stability	F_tot_20y	-4.6	–	4.6	ppm	Complies with Stratum 3E per GR-1244-CORE. Actual performance is better
Allan deviation	ADEV	–	1.5e-11	–	–	10 second averaging time <sup>[5]</sup>
<b>Frequency Stability – Synchronization Grade</b>						
Frequency Stability over Temperature	F_stab	–	–	±20	ppb	Over operating temperature range (T_oper); referenced to (max frequency + min frequency)/2 over the temperature range.
Initial Tolerance	F_init	–	–	±0.2	ppm	Initial frequency at 25°C at 48 hours after 2 reflows
Supply Voltage Sensitivity	F_Vdd	–	±1	±2	ppb	Over operating temperature range (T_oper); Vdd ±5%
Output Load Sensitivity	F_load	–	±0.5	±1	ppb	Over operating temperature (T_oper); LVCMOS output, 15 pF ±10%. Clipped sinewave, 10 kΩ    10 pF ±10%
Frequency vs. Temperature Slope	ΔF/ΔT	–	±0.6	±1	ppb/°C	0.5°C/min temperature ramp rate, over operating temperature (T_oper)
Dynamic Frequency Change during Temperature Ramp	F_dynamic	–	±0.006	±0.008	ppb/s	0.5°C/min temperature ramp rate, over operating temperature (T_oper)
Hysteresis Over Temperature Contact SiTime for lower hysteresis	F_hys	–	±2	±5	ppb	0.5°C/min ramp rate, defined as ±ΔF/2, over operating temperature (T_oper)
One-Day Aging	F_1d	–	±0.6	±1	ppb	At 85°C, after 30-days of continued operation. Aging is measured with respect to day 31
One-Year Aging	F_1y	–	–	±120	ppb	At 85°C, after 2-days of continued operation. Aging is measured with respect to day 3
20-Year Aging	F_20y	–	–	±200	ppb	
20-Year Total Stability	F_tot_20y	-4.6	–	4.6	ppm	Complies with Stratum 3 per GR-1244-CORE. Actual performance is better
Allan deviation	ADEV	–	1.5e-11	–	–	10 second averaging time <sup>[5]</sup>

**Note:**

5. Measured 2 hours after startup in a temperature chamber with a constant temperature in still air.

**Table 1. Output Characteristics (Continued)**

Parameters	Symbol	Min.	Typ.	Max.	Unit	Condition
<b>LVC MOS Output Characteristics</b>						
Duty Cycle	DC	45	–	55	%	
Rise/Fall Time	Tr, Tf	0.8	1.2	1.9	ns	10% - 90% Vdd
Output Voltage High	VOH	90%	–	–	Vdd	I <sub>OH</sub> = +3 mA
Output Voltage Low	VOL	–	–	10%	Vdd	I <sub>OL</sub> = -3 mA
Output Impedance	Z <sub>out_c</sub>	13	19	31	Ohms	Impedance looking into output buffer, all voltages
<b>Clipped Sinewave Output Characteristics</b>						
Output Voltage Swing	V <sub>out</sub>	0.8	–	1.2	V	Clipped sinewave output, 10 kΩ    10 pF ±10%
Rise/Fall Time	Tr, Tf	–	3.5	4.6	ns	20% - 80% Vdd, F <sub>nom</sub> = 19.2 MHz
<b>Start-up Characteristics</b>						
Start-up Time	T <sub>start</sub>	–	2.5	3.5	ms	Time to first pulse, measured from the time Vdd reaches 90% of its final value. Vdd ramp time is 500 μs, 0 V to Vdd
Output Enable Time	T <sub>oe</sub>	–	–	680	ns	F <sub>nom</sub> = 10 MHz. See <a href="#">Timing Diagrams</a> section below
Time to Rated Frequency Stability	T <sub>stability</sub>	–	0.2	1.6	s	Time to first accurate pulse within rated stability, measured from the time Vdd reaches 100% of its final value. Vdd ramp time = 500 μs

**Table 2. DC Characteristics**

Parameters	Symbol	Min.	Typ.	Max.	Unit	Condition
<b>Supply Voltage</b>						
Supply Voltage	Vdd	2.25	2.5	2.75	V	Contact SiTime for 2.25 V to 3.63 V continuous supply voltage support
		2.52	2.8	3.08	V	
		2.7	3.0	3.3	V	
		2.97	3.3	3.63	V	
Supply Voltage Ramp Time <sup>6)</sup>	Vdd_rt	500	–	–	μs	Measured from power up to 100% of Vdd
<b>Current Consumption</b>						
Current Consumption	I <sub>dd</sub>	–	44	53	mA	F <sub>nom</sub> = 19.2 MHz, No Load
OE Disable Current	I <sub>od</sub>	–	43	51	mA	OE = GND, output weakly pulled down

Note:

- 6. SiT5501 requires a minimum supply voltage ramp time of 500 μs.

**Table 3. Input Characteristics**

Parameters	Symbol	Min.	Typ.	Max.	Unit	Condition
<b>Input Characteristics – OE Pin</b>						
Input Impedance	Z <sub>in</sub>	75	–	–	kΩ	Internal pull up to Vdd
Input High Voltage	V <sub>IH</sub>	70%	–	–	Vdd	
Input Low Voltage	V <sub>IL</sub>	–	–	30%	Vdd	
<b>Frequency Tuning Range – I<sup>2</sup>C mode</b>						
Pull Range	PR	±6.25 ±10 ±12.5 ±25 ±50 ±80 ±100 ±125 ±150 ±200 ±400 ±600 ±800 ±1200 ±1600 ±3200	–	–	ppm	Digitally controlled mode

Table 3. Input Characteristics (Continued)

Parameters	Symbol	Min.	Typ.	Max.	Unit	Condition
Absolute Pull Range <sup>(7)</sup>	APR	±5.68	–	–	ppm	Over operating temperature range (T <sub>rated</sub> ); Digitally controlled mode for PR = ±6.25 ppm
<b>I<sup>2</sup>C Interface Characteristics, 200 Ohm, 550 pF (Max I<sup>2</sup>C Bus Load)</b>						
Bus Speed	F <sub>I2C</sub>	≤ 400			kHz	-40 to 105°C
		≤ 1000			kHz	-40 to 85°C
Input Voltage Low	VIL_I2C	–	–	30%	V <sub>dd</sub>	Digitally controlled mode
Input Voltage High	VIH_I2C	70%	–	–	V <sub>dd</sub>	Digitally controlled mode
Output Voltage Low	VOL_I2C	–	–	0.4	V	Digitally controlled mode
Input Leakage current	I <sub>L</sub>	0.5	–	24	µA	0.1 V <sub>DD</sub> < V <sub>OUT</sub> < 0.9 V <sub>DD</sub> . Includes typical leakage current from 200 kΩ pull resistor to V <sub>DD</sub> . Digitally controlled mode
Input Capacitance	C <sub>IN</sub>	–	–	5	pF	Digitally controlled mode

## Note:

7. APR = PR – initial tolerance – 20-year aging – frequency stability over temperature.

Table 4. Phase Noise

Parameters	Symbol	Min.	Typ.	Max.	Unit	Condition
<b>Phase Noise</b>						
1 Hz offset		–	-80	-77	dBc/Hz	F <sub>nom</sub> = 10 MHz Fixed frequency and digitally controlled mode with ±6.25 ppm pull range
10 Hz offset		–	-109	-106	dBc/Hz	
100 Hz offset		–	-130	-124	dBc/Hz	
1 kHz offset		–	-145	-140	dBc/Hz	
10 kHz offset		–	-148	-146	dBc/Hz	
100 kHz offset		–	-148	-146	dBc/Hz	
1 MHz offset		–	-163	-160	dBc/Hz	
5 MHz offset		–	-165	-160	dBc/Hz	
Spurious		–	–	-95	dBc/Hz	

**Table 5. Absolute Maximum Limits**

Attempted operation outside the absolute maximum ratings may cause permanent damage to the part. Actual performance of the IC is only guaranteed within the operational specifications, not at absolute maximum ratings.

Parameter	Test Conditions	Value	Unit
Storage Temperature		-65 to 125	°C
Continuous Power Supply Voltage Range (Vdd)		-0.5 to 4	V
Human Body Model (HBM) ESD Protection	JESD22-A114	2000	V
Soldering Temperature (follow standard Pb-free soldering guidelines)		260	°C
Junction Temperature <sup>[8]</sup>		130	°C
Input Voltage, Maximum	Any input pin	Vdd + 0.3	V
Input Voltage, Minimum	Any input pin	-0.3	V

**Table 6. Thermal Considerations<sup>[8]</sup>**

Package	$\theta_{JA}$ (°C/W)	$\Psi_{JT}$ (°C/W)	$\theta_{JB}$ (°C/W)	$\theta_{JC, Top}$ (°C/W)
Ceramic 7.0 mm x 5.0 mm	60.2	16.6	15.4	24.8

**Note:**

8.  $\theta_{JA}$ ,  $\Psi_{JT}$ ,  $\theta_{JB}$  and  $\theta_{JC}$  are provided according to JEDEC 51-2 and 51-3 with a 25°C ambient and 150 mW power consumption.  $\theta_{JB}$  and  $\theta_{JC}$  values apply for a two resistor model of the part in which heat flows from the junction to a heat sink through either the top of the case ( $\theta_{JC, Top}$ ) or the PCB ( $\theta_{JB}$ ). For a one resistor model  $\theta_{JB}$  is representative.  $\theta_{JA}$  is the thermal resistance to ambient on a JEDEC PCB - it is a highly conservative estimate of the thermal resistance to ambient for these parts, since the JEDEC board does not have vias to PCB planes in the vicinity of the part.  $\Psi_{JT}$  can be used to estimate the junction temperature from measurements of the temperature at the top of the part, as described in JEDEC 51-2.

**Table 7. Maximum Operating Junction Temperature<sup>[9]</sup>**

Max Operating Temperature (ambient)	Maximum Operating Junction Temperature
70°C	79°C
85°C	94°C
105°C	114°C

**Note:**

9. Datasheet specifications are not guaranteed if junction temperature exceeds the maximum operating junction temperature.

**Table 8. Environmental Compliance**

Parameter	Test Conditions	Value	Unit
Mechanical Shock Resistance	MIL-STD-883F, Method 2002	20000	<i>g</i>
Mechanical Vibration Resistance	MIL-STD-883F, Method 2007	70	<i>g</i>
Temperature Cycle	JESD22, Method A104	–	–
Solderability	MIL-STD-883F, Method 2003	–	–
Moisture Sensitivity Level	MSL1 @260°C	–	–

## Device Configurations and Pin-outs

Table 9. Device Configurations

Configuration	I <sup>2</sup> C Programmable Parameters
Fixed Frequency	–
Digitally Controlled	Frequency Pull Range, Frequency Pull Value, Output Enable control

### Pin-out Top Views

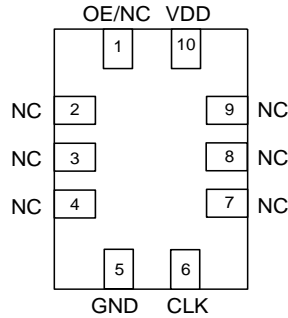

Figure 3. Fixed Frequency Device

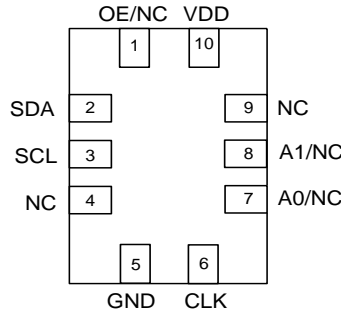

Figure 4. Digitally Controlled Device

Table 10. Pin Description

Pin	Symbol	I/O	Internal Pull-up/Pull Down Resistor	Function
1	OE / NC <sup>[12]</sup>	OE – Input	100 kΩ Pull-Up	H <sup>[10]</sup> : specified frequency output L: output is high impedance. Only output driver is disabled
		NC – No Connect	–	H or L or Open: No effect on output frequency or other device functions
2	SDA / NC <sup>[12]</sup>	SDA – Input/Output	200 kΩ Pull Up	I <sup>2</sup> C Serial Data
		NC – No Connect	–	H or L or Open: No effect on output frequency or other device functions
3	SCL / NC <sup>[12]</sup>	SCL – Input	200 kΩ Pull-Up	I <sup>2</sup> C serial clock input
		No Connect	–	H or L or Open: No effect on output frequency or other device functions
4	NC <sup>[13]</sup>	No Connect	–	H or L or Open: No effect on output frequency or other device functions
5	GND	Power	–	Connect to ground
6	CLK	Output	–	LVC MOS, or clipped sinewave oscillator output
7	A0/NC <sup>[12]</sup>	A0 – Input	100 kΩ Pull-Up	For DCTCXO ordering code “G” only: I <sup>2</sup> C Address Select, Least Significant Bit (LSB) <u>A1 A0 I<sup>2</sup>C Address</u> 0 0 1100000 0 1 1100010 1 0 1101000 1 1 1101010 (Default)
8	A1/NC <sup>[12]</sup>	A1 – Input	100 kΩ Pull-Up	
9	NC <sup>[12]</sup>	No Connect	–	H or L or Open: No effect on output frequency or other device functions
10	VDD	Power	–	Connect to power supply <sup>[11]</sup>

**Notes:**

- 10. In OE mode for noisy environments, a pull-up resistor of 10 kΩ or less is recommended if pin 1 is not externally driven. If pin 1 needs to be left floating, use the NC option.
- 11. A 0.1 μF capacitor in parallel with a 10 μF capacitor are required between VDD and GND. The 0.1 μF capacitor is recommended to place close to the device, and place the 10 μF capacitor less than 2 inches away.
- 12. All NC pins can be left floating and do not need to be soldered down.



## Waveforms

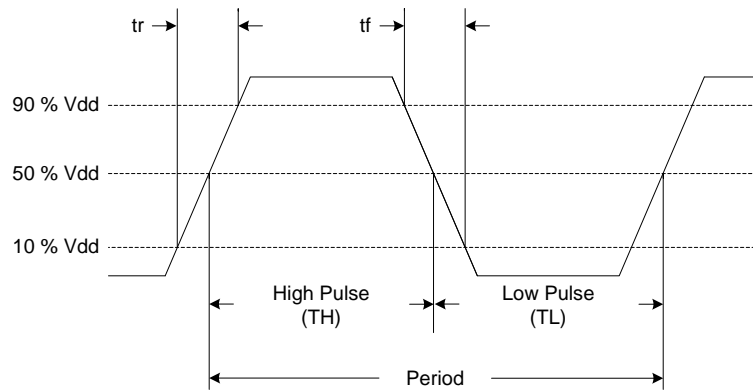

Figure 5. LVCMOS Waveform Diagram<sup>[13]</sup>

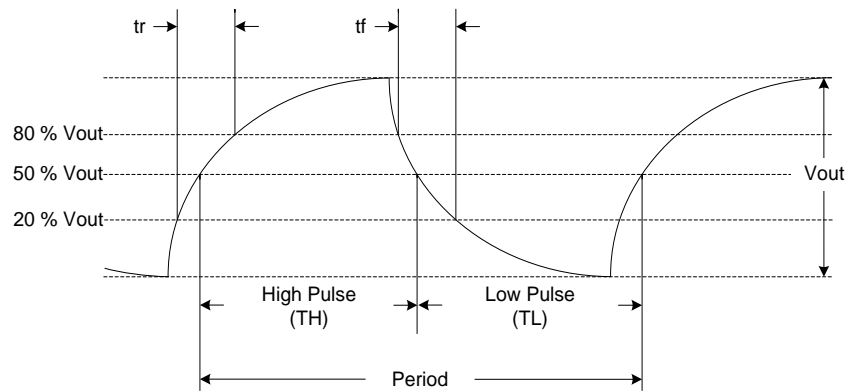
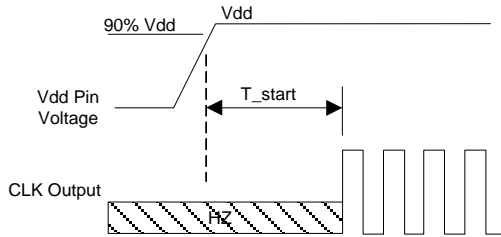

Figure 6. Clipped Sinewave Waveform Diagram<sup>[13]</sup>

**Note:**

13. Duty Cycle is computed as  $\text{Duty Cycle} = \text{TH}/\text{Period}$ .

## Timing Diagrams



T\_start: Time to start from power-off

**Figure 7. Startup Timing**

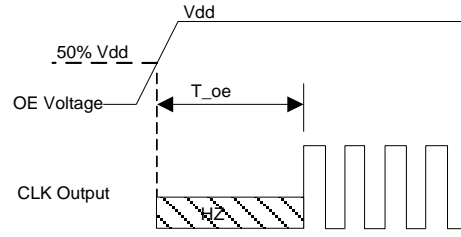

T\_oe: Time to re-enable the clock output

**Figure 8. OE Enable Timing (OE Mode Only)**

## Stability Diagrams

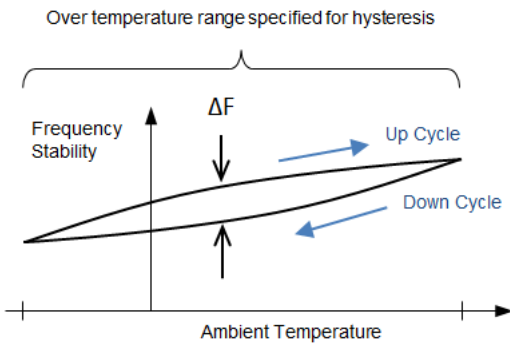

**Figure 9. Illustration of hysteresis, where  $\Delta F$  is max frequency difference between up and down cycles across temperature**

### Typical Performance Plots

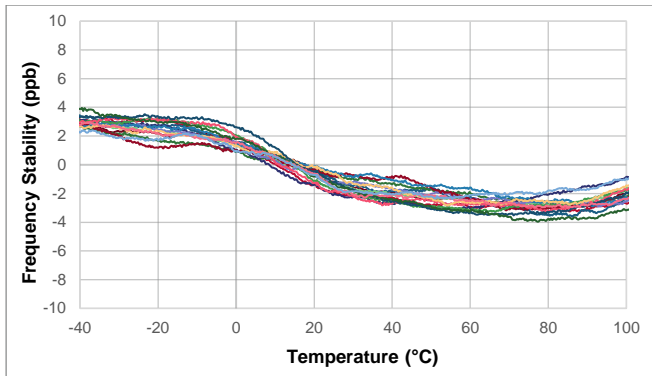

Figure 10. Frequency Stability

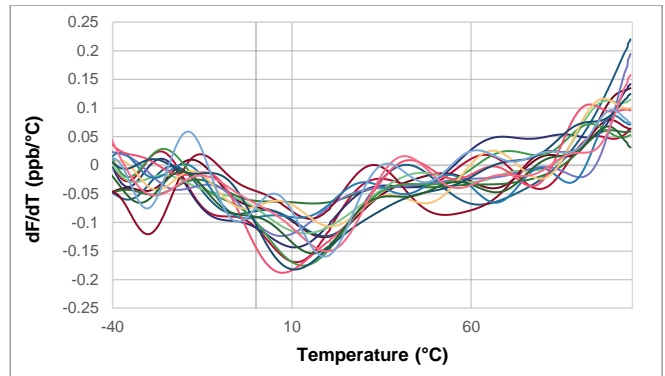

Figure 11. dF/dT

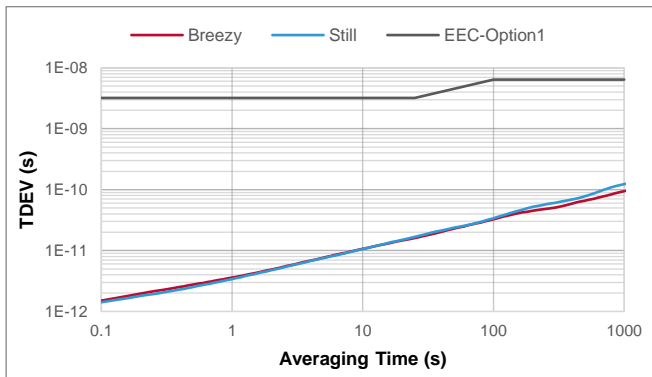

Figure 12. TDEV – Loop Bandwidth 3 Hz

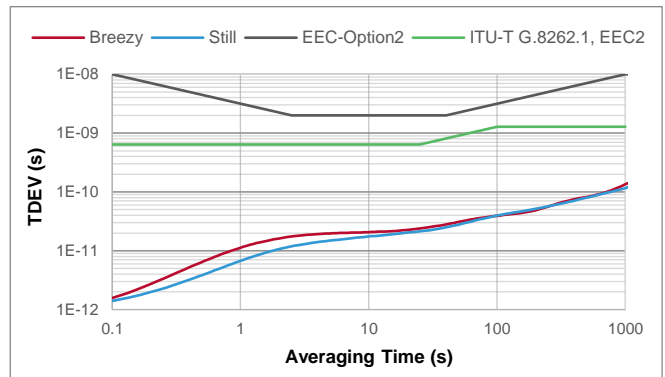

Figure 13. TDEV – Loop Bandwidth 0.1 Hz

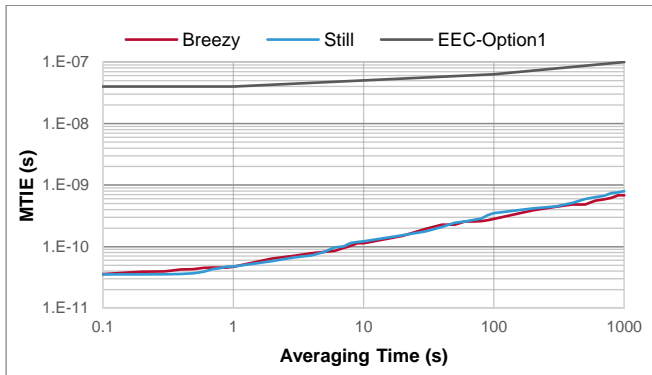

Figure 14. MTIE – Loop Bandwidth 3 Hz

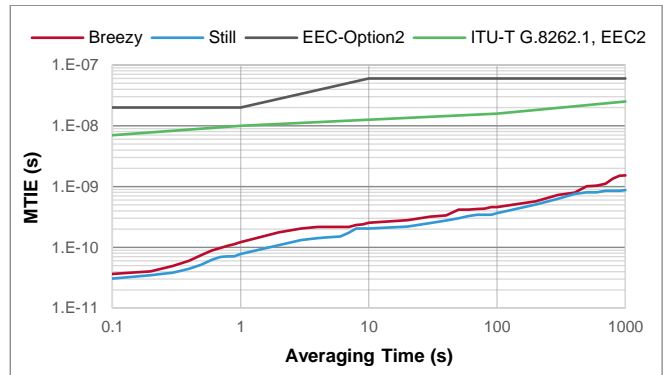

Figure 15. MTIE – Loop Bandwidth 0.1 Hz

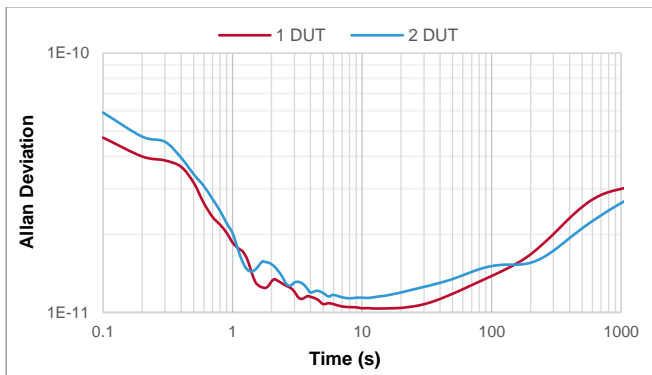

Figure 16. ADEV – Still Air

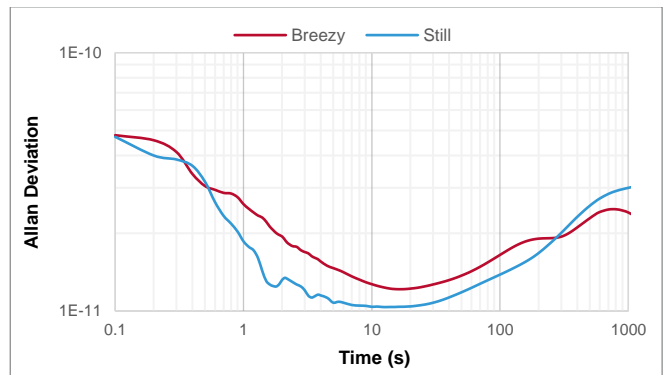

Figure 17. ADEV – Breezy Air

Typical Performance Plots (continued)

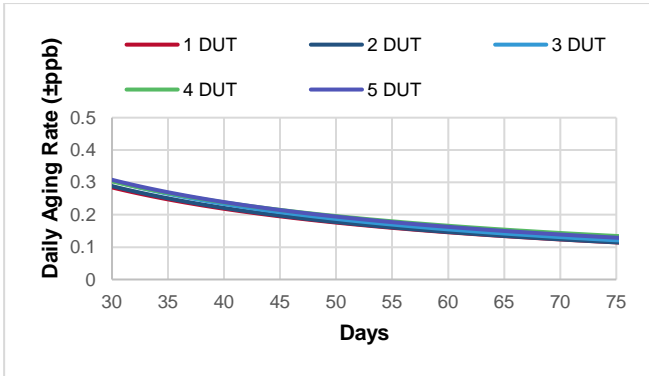

Figure 18. Daily Aging Rate After 30 Days

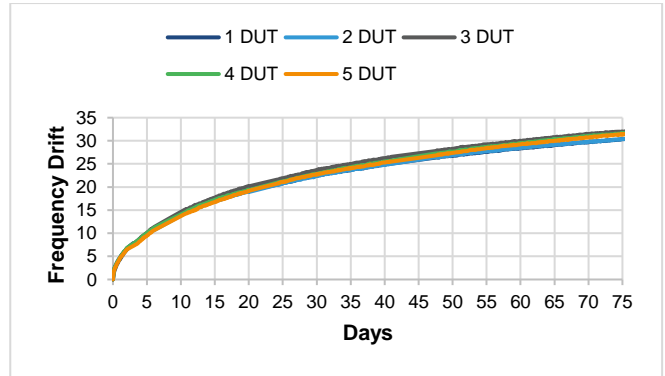

Figure 19. Frequency Drift

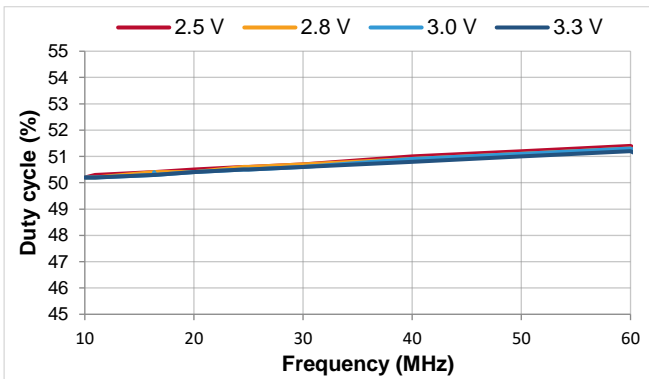

Figure 20. Duty Cycle (LVCMOS)

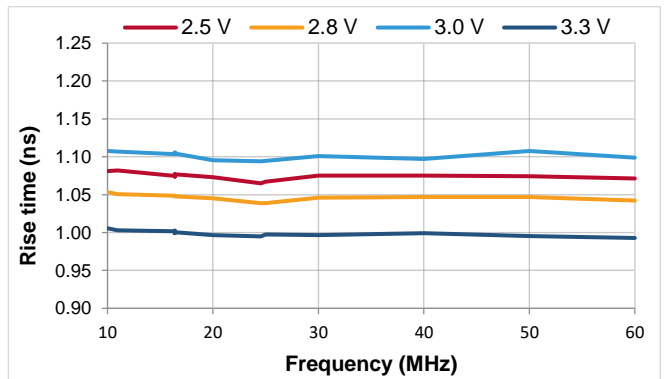

Figure 21. Rise Time (LVCMOS)

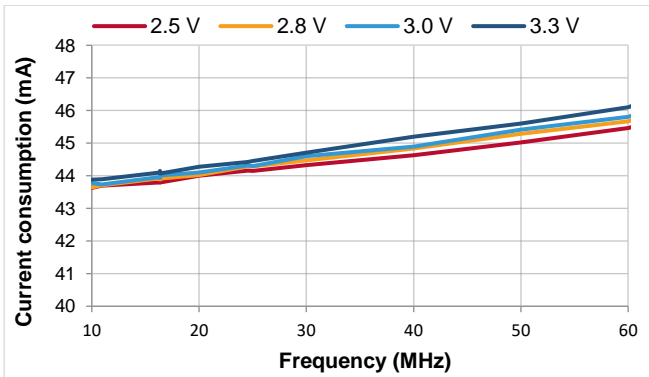

Figure 22. IDD TCXO (LVCMOS)

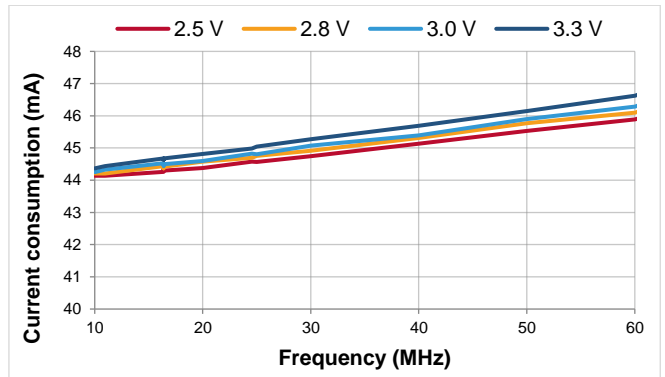

Figure 23. IDD DCTCXO (LVCMOS)

Typical Performance Plots (continued)

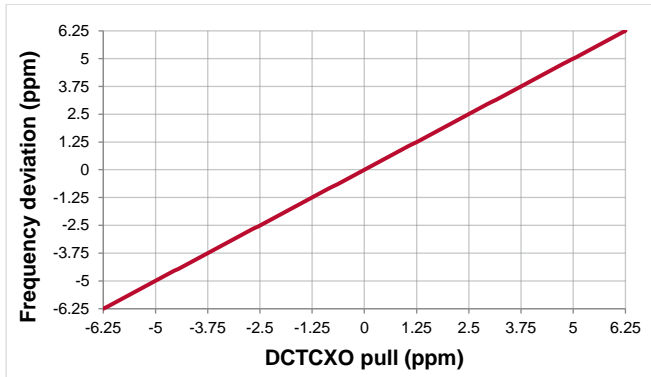

Figure 24. DCTCXO frequency pull characteristic

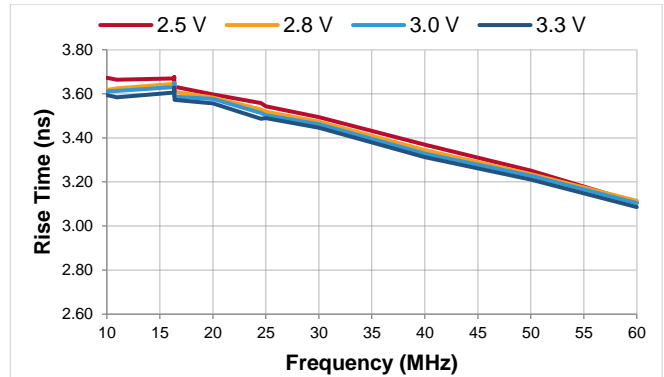

Figure 25. Rise Time (Clipped Sinewave)

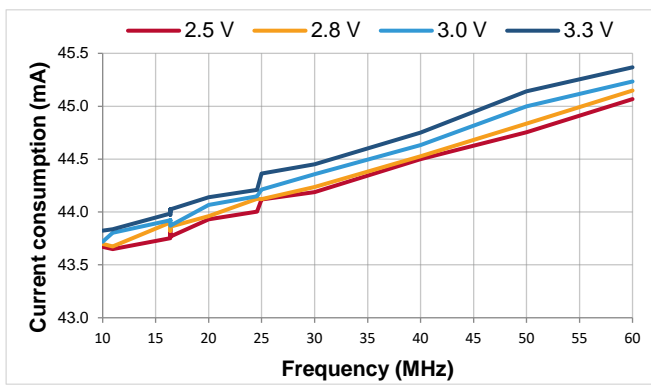

Figure 26. IDD TCXO (Clipped Sinewave)

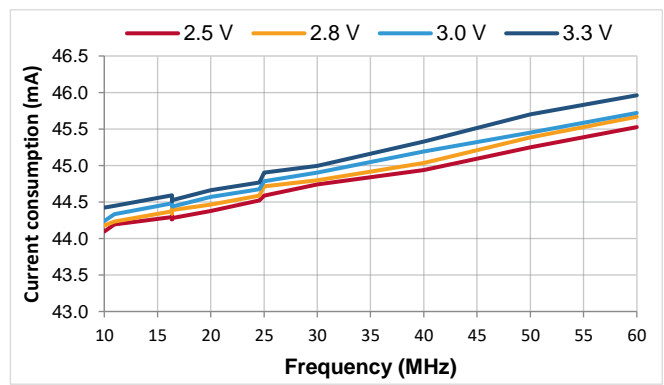

Figure 27. IDD DCTCXO (Clipped Sinewave)

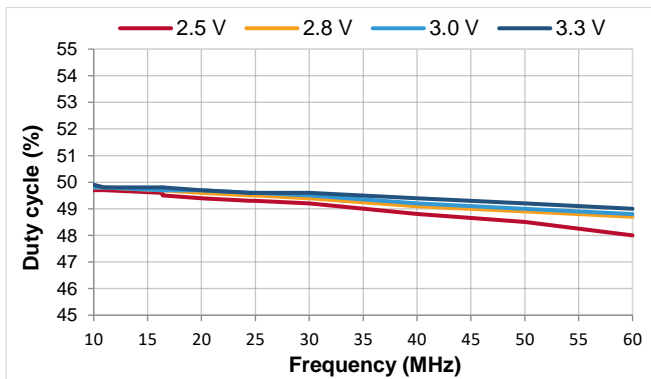

Figure 28. Duty Cycle (Clipped Sinewave)

## Architecture Overview

Based on SiTime's innovative Elite Platform®, the SiT5501 delivers exceptional dynamic performance, i.e. resilience to environmental stressors such as shock, vibration, and fast temperature transients. Underpinning the Elite platform are SiTime's unique DualMEMS® temperature sensing architecture and TurboCompensation™ technologies.

DualMEMS is a noiseless temperature compensation scheme. It consists of two MEMS resonators fabricated on the same die substrate. The TempFlat® MEMS resonator is designed with a flat frequency characteristic over temperature whereas the temperature sensing resonator is by design sensitive to temperature changes. The ratio of frequencies between these two resonators provides an accurate reading of the resonator temperature with 20  $\mu$ K resolution.

By placing the two MEMS resonators on the same die, this temperature sensing scheme eliminates any thermal lag and gradients between resonator and temperature sensor, thereby overcoming an inherent weakness of legacy quartz TCXOs.

The DualMEMS temperature sensor drives a state-of-the-art CMOS temperature compensation circuit. The TurboCompensation design, with >100 Hz compensation bandwidth, achieves a dynamic frequency stability that is far superior to any quartz TCXO. The digital temperature compensation enables additional optimization of frequency stability and frequency slope over temperature within any chosen temperature range for a given system design.

The Elite platform also incorporates a high resolution, low noise frequency synthesizer along with the industry standard I<sup>2</sup>C bus. This unique combination enables system designers to digitally control the output frequency in steps as low as 5 ppt and over a wide range up to  $\pm$ 3200 ppm.

For more information regarding the Elite platform and its benefits please visit:

- [SiTime's breakthroughs](#) section
- TechPaper: [DualMEMS Temperature Sensing Technology](#)
- TechPaper: [DualMEMS Resonator TDC](#)

## Functional Overview

The SiT5501 is designed for maximum flexibility with an array of factory programmable options, enabling system designers to configure this precision device for optimal performance in a given application.

### Output Frequency and Format

The SiT5501 can be factory programmed for an output frequency without sacrificing lead time or incurring an upfront customization cost typically associated with custom-frequency quartz TCXOs.

The device supports both LVCMOS and clipped sinewave output. Ordering codes for the output format are shown below:

**Table 11. Output Formats vs. Ordering Codes**

Output Format	Ordering Code
LVCMOS	"-"
Clipped Sinewave	"C"

### Output Frequency Tuning

In addition to the non-pullable TCXO, the SiT5501 can also support output frequency tuning through an I<sup>2</sup>C interface (DCTCXO). The I<sup>2</sup>C interface enables 16 factory programmed pull-range options from  $\pm$ 6.25 ppm to  $\pm$ 3200 ppm. The pull range can also be reprogrammed via I<sup>2</sup>C to any supported pull-range value. Refer to [Device Configuration](#) section for details.

**Pin 1 Configuration (OE, VC, or NC)**

Pin 1 of the SiT5501 can be factory programmed to support two modes: Output Enable (OE) or No Connect (NC).

**Table 12. Pin Configuration Options**

Pin 1 Configuration	Operating Mode	Output
OE	TCXO/DCTCXO	Active or High-Z
NC	TCXO/DCTCXO	Active

When pin 1 is configured as OE pin, the device output is guaranteed to operate in one of the following two states:

- Clock output with the frequency specified in the part number when Pin 1 is pulled to logic high
- Hi-Z mode with weak pull down when pin 1 is pulled to logic low.

When pin 1 is configured as NC, the device is guaranteed to output the frequency specified in the part number at all times, regardless of the logic level on pin 1.

**Device Configurations**

The SiT5501 supports 2 device configurations – TCXO and DCTCXO. The TCXO option is directly compatible with the quartz TCXO. The DCTCXO configuration provides performance enhancement by eliminating VCTCXO’s sensitivity to control voltage noise with an I<sup>2</sup>C digital interface for frequency tuning.

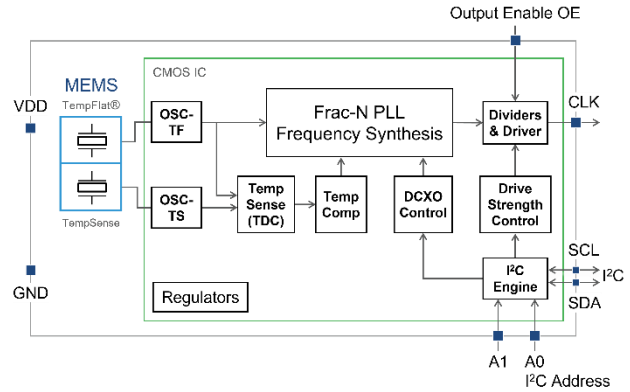

**Figure 29. Block Diagram – TCXO**

**TCXO Configuration**

The TCXO configuration generates a fixed frequency output, as shown in Figure 29. The frequency is specified by the user in the frequency field of the device ordering code and then factory programmed. Other factory programmable options include supply voltage, output types (LVCMOS or clipped sinewave), and pin 1 functionality (OE or NC).

Refer to the [Ordering Information](#) section at the end of the datasheet for a list of all ordering options.





Table 13. Additional Information

Document	Description	Download Link
<b>ECCN #: EAR99</b>	Five character designation used on the commerce Control List (CCL) to identify dual use items for export control purposes.	—
<b>HTS Classification Code: 8542.39.0000</b>	A Harmonized Tariff Schedule (HTS) code developed by the World Customs Organization to classify/define internationally traded goods.	—
<b>Evaluation Boards</b>	SiT6723EB Evaluation Board User Manual	<a href="#">Contact SiTime</a>
<b>Demo Board</b>	SiT6702DM Demo Board User Manual	<a href="#">Contact SiTime</a>
<b>Time Machine II</b>	MEMS oscillator programmer	<a href="http://www.sitime.com/support/time-machine-oscillator-programmer">http://www.sitime.com/support/time-machine-oscillator-programmer</a>
<b>Time Master Web-based Configurator</b>	Web tool to establish proper programming	<a href="https://www.sitime.com/time-master-web-based-configurator">https://www.sitime.com/time-master-web-based-configurator</a>
<b>Manufacturing Notes</b>	Tape & Reel dimension, reflow profile and other manufacturing related info	<a href="https://www.sitime.com/api/gated/Manufacturing-Notes-for-SiTime-Products.pdf">https://www.sitime.com/api/gated/Manufacturing-Notes-for-SiTime-Products.pdf</a>
<b>Qualification Reports</b>	RoHS report, reliability reports, composition reports	—
<b>Performance Reports</b>	Additional performance data such as phase noise, current consumption and jitter for selected frequencies	<a href="#">Contact SiTime</a>
<b>Termination Techniques</b>	Termination design recommendations	<a href="http://www.sitime.com/support/application-notes">http://www.sitime.com/support/application-notes</a>
<b>Layout Techniques</b>	Layout recommendations	<a href="http://www.sitime.com/support/application-notes">http://www.sitime.com/support/application-notes</a>

## Revision History

Table 14. Revision History

Version	Release Date	Change Summary
0.55	2-Feb-2021	First release, advanced information
0.56	2-Mar-2021	Updated time to rated stability specification Updated phase noise specification Updated Pin Out Drawings
0.57	3-Mar-2021	Added note to contact SiTime for alternate packages
0.58	12-Apr-2021	Resolved typographical error in ordering code
0.59	30-Jun-2021	Updated package drawing and changed package ordering code to "W"
0.60	31-Jan-2022	Extended operating temperature range of $\pm 10$ ppb stability to -40 to 105°C Added A1 address select to pin descriptions, block diagram Added various typical performance plots
0.61	9-Mar-2022	Edited the product name in the header Added the Stratum 3 stability grade and associated output characteristics Resolved a typographical error regarding the absolute pull range
0.62	21-Apr-2022	Added commercial temperature range option
0.63	19-Jul-2022	Added Voltage Supply Ramp Time specification to DC characteristics Added Appendix: Elite X™ DCTCXO Programming Guide
1.0	3-Feb-2023	Various updates to the features page Added various minimum and maximum limits to the electrical characteristics Revised various typical values in the electrical specifications Revised typical values and added maximum limits to the phase noise specifications Added note 8 on thermal considerations Revised performance plots with characterized data Added "F" packaging option to the ordering code Added note 3 on minimum quantity for "F" ordering code
1.01	9-Feb-2023	Revised typographical error in Maximum Operating Junction Temperature (Table 7) Added Additional Information (Table 13)
1.02	17-Apr-2023	Revised various formatting errors

**SiTime Corporation, 5451 Patrick Henry Drive, Santa Clara, CA 95054, USA | Phone: +1-408-328-4400 | Fax: +1-408-328-4439**

© SiTime Corporation 2021-2023. The information contained herein is subject to change at any time without notice. SiTime assumes no responsibility or liability for any loss, damage or defect of a Product which is caused in whole or in part by (i) use of any circuitry other than circuitry embodied in a SiTime product, (ii) misuse or abuse including static discharge, neglect or accident, (iii) unauthorized modification or repairs which have been soldered or altered during assembly and are not capable of being tested by SiTime under its normal test conditions, or (iv) improper installation, storage, handling, warehousing or transportation, or (v) being subjected to unusual physical, thermal, or electrical stress.

**Disclaimer:** SiTime makes no warranty of any kind, express or implied, with regard to this material, and specifically disclaims any and all express or implied warranties, either in fact or by operation of law, statutory or otherwise, including the implied warranties of merchantability and fitness for use or a particular purpose, and any implied warranty arising from course of dealing or usage of trade, as well as any common-law duties relating to accuracy or lack of negligence, with respect to this material, any SiTime product and any product documentation. This product is not suitable or intended to be used in a life support application or component, to operate nuclear facilities, in military or aerospace applications, or in other mission critical applications where human life may be involved or at stake. All sales are made conditioned upon compliance with the critical uses policy set forth below.

#### CRITICAL USE EXCLUSION POLICY

BUYER AGREES NOT TO USE SITIME'S PRODUCTS FOR ANY APPLICATION OR IN ANY COMPONENTS: USED IN LIFE SUPPORT DEVICES, TO OPERATE NUCLEAR FACILITIES, FOR MILITARY AEROSPACE USE, OR IN OTHER MISSION-CRITICAL APPLICATIONS OR COMPONENTS WHERE HUMAN LIFE OR PROPERTY MAY BE AT STAKE.

SiTime owns all rights, title and interest to the intellectual property related to SiTime's products, including any software, firmware, copyright, patent, or trademark. The sale of SiTime products does not convey or imply any license under patent or other rights. SiTime retains the copyright and trademark rights in all documents, catalogs and plans supplied pursuant to or ancillary to the sale of products or services by SiTime. Unless otherwise agreed to in writing by SiTime, any reproduction, modification, translation, compilation, or representation of this material shall be strictly prohibited.

# Appendix



## DCTCXO-Specific Design Considerations

### Pull Range and Absolute Pull Range

Table 15 Table below shows the pull range and corresponding APR values for each of the frequency vs. temperature ordering options.

**Table 15. APR Options<sup>[14]</sup>**

Pull Range Ordering Code	Pull Range ppm	APR ppm ±10 ppb option	APR ppm ±20 ppb option
T	±6.25	±5.84	±5.68
R	±10	±9.59	±9.43
Q	±12.5	±12.09	±11.93
M	±25	±24.59	±24.43
B	±50	±49.59	±49.43
C	±80	±79.59	±79.43
E	±100	±99.59	±99.43
F	±125	±124.59	±124.43
G	±150	±149.59	±149.43
H	±200	±199.59	±199.43
X	±400	±399.59	±399.43
L	±600	±599.59	±599.43
Y	±800	±799.59	±799.43
S	±1200	±1199.59	±1199.43
Z	±1600	±1599.59	±1599.43
U	±3200	±3199.59	±3199.43

**Notes:**

- 14. APR includes initial tolerance, frequency stability vs. temperature, and the indicated 20-year aging.

## Output Frequency

The device powers up at the nominal operating frequency and pull range specified by the ordering code. After power-up both pull range and output frequency can be controlled via I<sup>2</sup>C writes to the respective control registers. The maximum output frequency change is constrained by the pull range limits.

The pull range is specified by the value loaded in the digital pull-range control register. The 16 pull range choices are specified in the control register and range from ±6.25 ppm to ±3200 ppm.

Table 16 below shows the frequency resolution versus pull range programmed value.

**Table 16. Frequency Resolution versus Pull Range**

Programmed Pull Range	Frequency Resolution
±6.25 ppm	5x10 <sup>-12</sup>
±10 ppm	5x10 <sup>-12</sup>
±12.5 ppm	5x10 <sup>-12</sup>
±25 ppm	5x10 <sup>-12</sup>
±50 ppm	5x10 <sup>-12</sup>
±80 ppm	5x10 <sup>-12</sup>
±100 ppm	5x10 <sup>-12</sup>
±120 ppm	5x10 <sup>-12</sup>
±150 ppm	5x10 <sup>-12</sup>
±200 ppm	5x10 <sup>-12</sup>
±400 ppm	1x10 <sup>-11</sup>
±600 ppm	1.4x10 <sup>-11</sup>
±800 ppm	2.1x10 <sup>-11</sup>
±1200 ppm	3.2x10 <sup>-11</sup>
±1600 ppm	4.7x10 <sup>-11</sup>
±3200 ppm	9.4x10 <sup>-11</sup>

The ppm frequency offset is specified by the 26 bit DCXO frequency control register in two's complement format as described in the I<sup>2</sup>C Register Descriptions. The power up default value is 000000000000000000000000b which sets the output frequency at its nominal value (0 ppm). To change the output frequency, a frequency control word is written to 0x00[15:0] (Least Significant Word) and 0x01[9:0] (Most Significant Word). The LSW value should be written first followed by the MSW value; the frequency change is initiated after the MSW value is written.

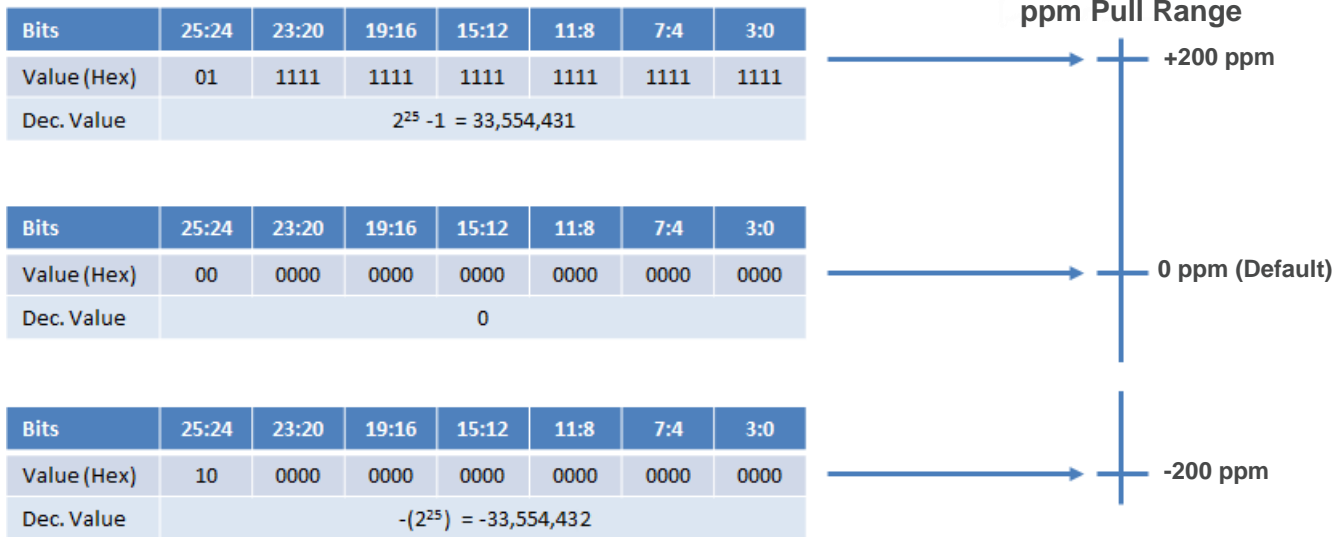

Figure 31. Pull Range and Frequency Control Word

Figure 31 shows how the two's complement signed value of the frequency control word sets the output frequency within the ppm pull range set by 0x02:[3:0]. This example shows use of the ±200 ppm pull range. Therefore, to set the desired output frequency, one just needs to calculate the fraction of full scale value ppm, convert to two's complement binary, and then write these values to the frequency control registers.

The following formula generates the control word value:

**Control word value = RND( $2^{25}-1$ ) × ppm shift from nominal/pull range)**, where RND is the rounding function which rounds the number to the nearest whole number. Two examples follow, assuming a ±200 ppm pull range:

**Example 1:**

- Default Output Frequency = 19.2 MHz
- Desired Output Frequency = 19.201728 MHz (+90 ppm)

$2^{25}-1$  corresponds to +200 ppm, and the fractional value required for +90 ppm can be calculated as follows.

90 ppm / 200 ppm × ( $2^{25}-1$ ) = 15,099,493.95.

Rounding to the nearest whole number yields 15,099,494 and converting to two's complement gives a binary value of 111001100110011001100110, or E66666 in hex.

**Example 2:**

- Default Output Frequency = 10 MHz
- Desired Output Frequency = 9.9995 MHz (-50 ppm)

Following the formula shown above,

$(-50 \text{ ppm} / 200 \text{ ppm}) \times (2^{25}) = -8,388,608.$

Converting this to two's complement binary results in 111000000000000000000000, or 3800000 in hex.

To summarize, the procedure for calculating the frequency control word associated with a given ppm offset is as follows:

- 1) Calculate the fraction of the half-pull range needed. For example, if the total pull range is set for ±100 ppm and a +20 ppm shift from the nominal frequency is needed, this fraction is 20 ppm/100 ppm = 0.2
- 2) Multiply this fraction by the full-half scale word value,  $2^{25}-1 = 33,554,431$ , round to the nearest whole number, and convert the result to two's complement binary. Following the +20 ppm example, this value is  $0.2 \times 33,554,431 = 6,710,886.2$  and rounded to 6,710,886.
- 3) Write the two's complement binary value starting with the Least Significant Word (LSW) 0x00[16:0], followed by the Most Significant Word (MSW), 0x01[9:0]. If the user desires that the output remains enabled while changing the frequency, a 1 must also be written to the OE control bit 0x01[10] if the device has software OE Control Enabled.

It is important to note that the maximum Digital Control update rate is 38 kHz regardless of I<sup>2</sup>C bus speed.

## I<sup>2</sup>C Control Registers

The SiT5501 enables control of frequency pull range, frequency pull value, and Output Enable via I<sup>2</sup>C writes to the control registers. Table 17 below shows the register map summary, and detailed register descriptions follow.

**Table 17. Register Map Summary**

Address	Bits	Access	Description
0x00	[15:0]	RW	DIGITAL FREQUENCY CONTROL LEAST SIGNIFICANT WORD (LSW)
0x01	[15:11]	R	NOT USED
	[10]	RW	OE Control. This bit is only active if the output enable function is under software control. If the device is configured for hardware control using the OE pin, writing to this bit has no effect.
	[9:0]	RW	DIGITAL FREQUENCY CONTROL MOST SIGNIFICANT WORD (MSW)
0x02	[15:4]	R	NOT USED
	[3:0]	RW	DIGITAL PULL RANGE CONTROL

## Register Descriptions

### Register Address: 0x00. Digital Frequency Control Least Significant Word (LSW)

Bit	15	14	13	12	11	10	9	8	7	6	5	4	3	2	1	0
Access	RW	RW	RW	RW	RW	RW	RW	RW	RW	RW	RW	RW	RW	RW	RW	RW
Default	0	0	0	0	0	0	0	0	0	0	0	0	0	0	0	0
Name	DIGITAL FREQUENCY CONTROL LEAST SIGNIFICANT WORD (LSW)[15:0]															

Bits	Name	Access	Description
15:0	DIGITAL FREQUENCY CONTROL LEAST SIGNIFICANT WORD	RW	<p>Bits [15:0] are the lower 16 bits of the 26 bit FrequencyControlWord and are the Least Significant Word (LSW). The upper 10 bits are in register 0x01[9:0] and are the Most Significant Word (MSW). The lower 16 bits together with the upper 10 bits specify a 26-bit frequency control word.</p> <p>This power-up default values of all 26 bits are 0 which sets the output frequency at its nominal value. After power-up, the system can write to these two registers to pull the frequency across the pull range. The register values are two's complement to support positive and negative control values. The LSW value should be written before the MSW value because the frequency change is initiated when the new values are loaded into the MSW. More details and examples are discussed in the previous section.</p>



## Register Address: 0x01. OE Control, Digital Frequency Control Most Significant Word (MSW)

Bit	15	14	13	12	11	10	9	8	7	6	5	4	3	2	1	0
Access	R	R	R	R	R	RW	RW	RW	RW	RW	RW	RW	RW	RW	RW	RW
Default	0	0	0	0	0	0	0	0	0	0	0	0	0	0	0	0
Name	NOT USED					OE	DCXO FREQUENCY CONTROL[9:0] MSW									

Bits	Name	Access	Description
15:11	NOT USED	R	Bits [15:10] are read only and return all 0's when read. Writing to these bits has no effect.
10	OE Control	RW	Output Enable Software Control. Allows the user to enable and disable the output driver via I <sup>2</sup> C. 0 = Output Disabled (Default) 1 = Output Enabled  This bit is only active if the Output Enable function is under software control. If the device is configured for hardware control using the OE pin, writing to this bit has no effect.
9:0	DIGITAL FREQUENCY CONTROL MOST SIGNIFICANT WORD (MSW)	RW	Bits [9:0] are the upper 10 bits of the 26 bit FrequencyControlWord and are the Most Significant Word (MSW). The lower 16 bits are in register 0x00[15:0] and are the Least Significant Word (LSW). These lower 16 bits together with the upper 10 bits specify a 26-bit frequency control word.  This power-up default values of all 26 bits are 0 which sets the output frequency at its nominal value. After power-up, the system can write to these two registers to pull the frequency across the pull range. The register values are two's complement to support positive and negative control values. The LSW value should be written before the MSW value because the frequency change is initiated when the new values are loaded into the MSW. More details and examples are discussed in the previous section.

## Register Address: 0x02. DIGITAL PULL RANGE CONTROL<sup>[15]</sup>

Bit	15	14	13	12	11	10	9	8	7	6	5	4	3	2	1	0
Access	R	R	R	R	R	R	R	R	R	R	R	R	RW	RW	RW	RW
Default	0	0	0	0	0	0	0	0	0	0	0	0	X	X	X	X
Name	NONE												DIGITAL PULL RANGE CONTROL			

**Notes:**

15. Default values are factory set but can be over-written after power-up.

Bits	Name	Access	Description
15:4	NONE	R	Bits [15:4] are read only and return all 0's when read. Writing to these bits has no effect.
3:0	DIGITAL PULL RANGE CONTROL	RW	<p>Sets the digital pull range of the DCXO. The table below shows the available pull range values and associated bit settings. The default value is factory programmed.</p> <p><b>Bit</b> <b>3 2 1 0</b></p> <p>0 0 0 0: ±6.25 ppm                      0 0 0 1: ±10 ppm                      0 0 1 0: ±12.5 ppm                      0 0 1 1: ±25 ppm                      0 1 0 0: ±50 ppm                      0 1 0 1: ±80 ppm                      0 1 1 0: ±100 ppm                      0 1 1 1: ±125 ppm                      1 0 0 0: ±150 ppm                      1 0 0 1: ±200 ppm                      1 0 1 0: ±400 ppm                      1 0 1 1: ±600 ppm                      1 1 0 0: ±800 ppm                      1 1 0 1: ±1200 ppm                      1 1 1 0: ±1600 ppm                      1 1 1 1: ±3200 ppm</p>

## Serial Interface Configuration Description

The SiT5501 includes an I<sup>2</sup>C interface to access registers that control the DCTCXO frequency pull range, and frequency pull value. The SiT5501 I<sup>2</sup>C slave-only interface supports clock speeds up to 1 Mbit/s. The SiT5501 I<sup>2</sup>C module is based on the I<sup>2</sup>C specification, UM1024 (Rev.6 April 4, 2014 of NXP Semiconductor).

## Serial Signal Format

The SDA line must be stable during the high period of the SCL. SDA transitions are allowed only during SCL low level for data communication. Only one transition is allowed during the low SCL state to communicate one bit of data. [Figure 32](#) shows the detailed timing diagram.

An idle I<sup>2</sup>C bus state occurs when both SCL and SDA are not being driven by any master and are therefore in a logic HI state due to the pull up resistors. Every transaction begins with a START (S) signal and ends with a STOP (P) signal. A START condition is defined by a high to low transition on the SDA while SCL is high. A STOP condition is defined by a low to high transition on the SDA while SCL is high. START and STOP conditions are always generated by the master. This slave module also supports repeated START (Sr) condition which is same as START condition instead of STOP condition (the blue-color line shows repeated START in [Figure 33](#)).

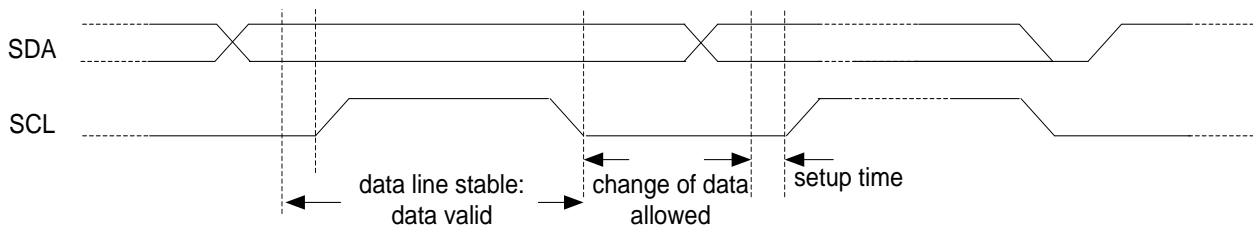

**Figure 32. Data and clock timing relation in I<sup>2</sup>C bus**

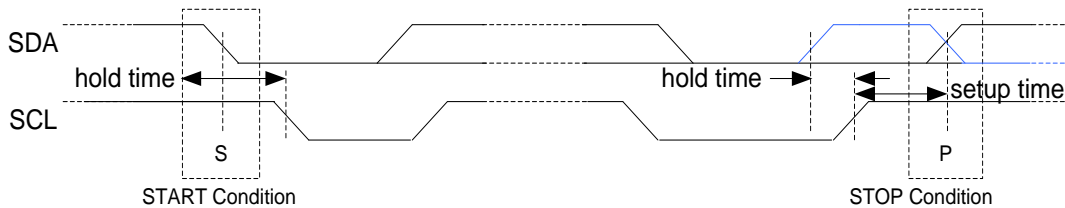

**Figure 33. START and STOP (or repeated START, blue line) condition**

## Parallel Signal Format

Every data byte is 8 bits long. The number of bytes that can be transmitted per transfer is unrestricted. Data is transferred with the MSB (Most Significant Bit) first. The detailed data transfer format is shown in Figure 35 below.

The acknowledge bit must occur after every byte transfer and it allows the receiver to signal the transmitter that the byte was successfully received and another byte may be sent. The acknowledge signal is defined as follows: the transmitter releases the SDA line during the acknowledge clock pulse so the receiver can pull the SDA line low and it remains stable low during the high period of this clock pulse. Setup and hold times must also be taken into account. When SDA remains high during this ninth clock pulse, this is defined as the Not-Acknowledge signal (NACK). The master can then generate either a STOP condition to abort the transfer, or a repeated START condition to start a new transfer. The only condition that leads to the generation of NACK from the SiT5501 is when the transmitted address does not match the slave address. When the master is reading data from the SiT5501, the SiT5501 expects the ACK from the master at the end of received data, so that the slave releases the SDA line and the master can generate the STOP or repeated START. If there is a NACK signal at the end of the data, then the SiT5501 tries to send the next data. If the first bit of the next data is “0”, then the SiT5501 holds the SDA line to “0”, thereby blocking the master from generating a STOP/(re)START signal.

## Parallel Data Format

This I<sup>2</sup>C slave module supports 7-bit device addressing format. The 8<sup>th</sup> bit is a read/write bit and “1” indicates a read transaction and a “0” indicates a write transaction. The register addresses are 8-bits long with an address range of 0 to 255 (00h to FFh). Auto address incrementing is supported which allows data to be transferred to contiguous addresses without the need to write each address beyond the first address. Since the maximum register address value is 255, the address will roll from 255 back to 0 when auto address incrementing is used. Obviously, auto address incrementing should only be used for writing to contiguous addresses. The data format is 16-bit (two bytes) with the most significant byte being transferred first. For a read operation, the starting register address must be written first. If that is omitted, reading will start from the last address in the auto-increment counter of the device, which has a startup default of 0x00.

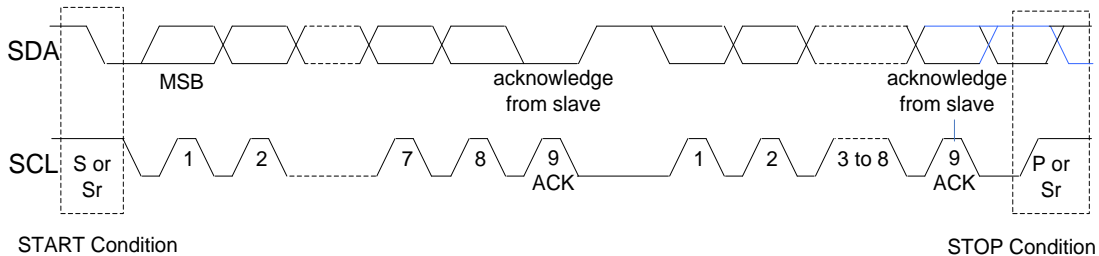

Figure 34. Parallel signaling format

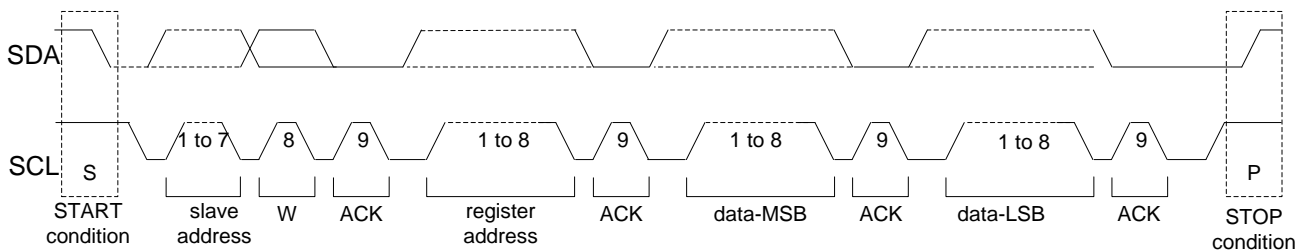

Figure 35. Parallel data byte format, write operation

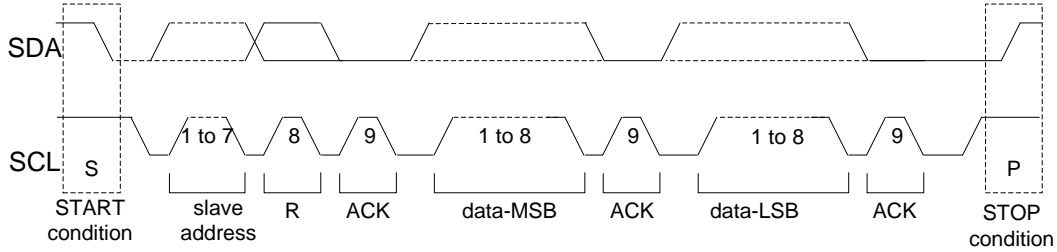

Figure 36. Parallel data byte format, read operation

Figure 37 below shows the I<sup>2</sup>C sequence for writing the 4-byte control word using auto address incrementing.

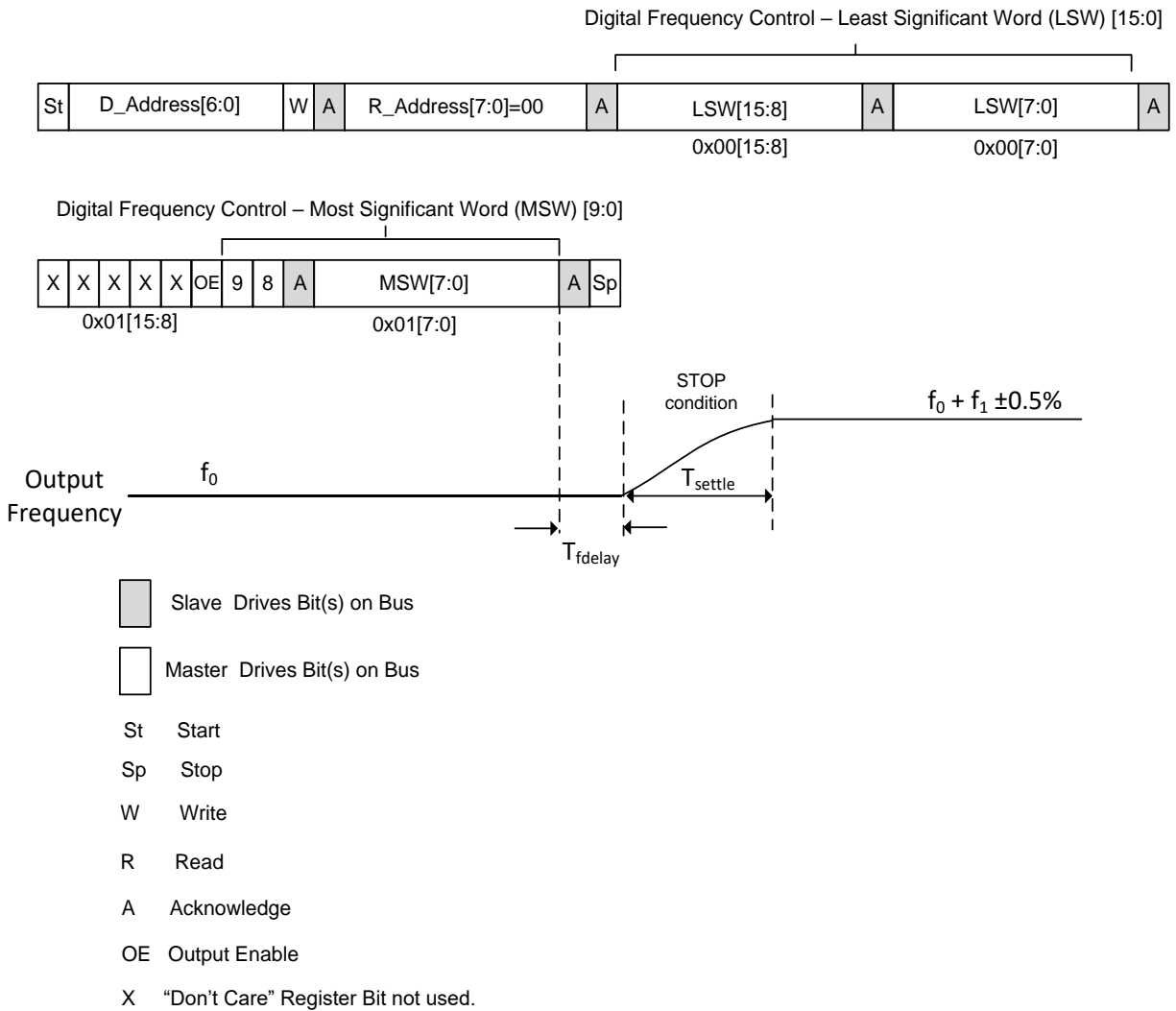

Figure 37. Writing the Frequency Control Word

Table 15. DCTCXO Delay and Settling Time

Parameter	Symbol	Minimum	Typical	Maximum	Units	Notes
Frequency Change Delay	T <sub>fdelay</sub>	–	103	140	µs	Time from end of 0x01 reg MSW to start of frequency pull, as shown in Figure 36
Frequency Settling Time	T <sub>settle</sub>	–	16.5	20	µs	Time to settle to 0.5% of frequency offset, as shown in Figure 37

## I<sup>2</sup>C Timing Specification

The below timing diagram and table illustrate the timing relationships for both master and slave.

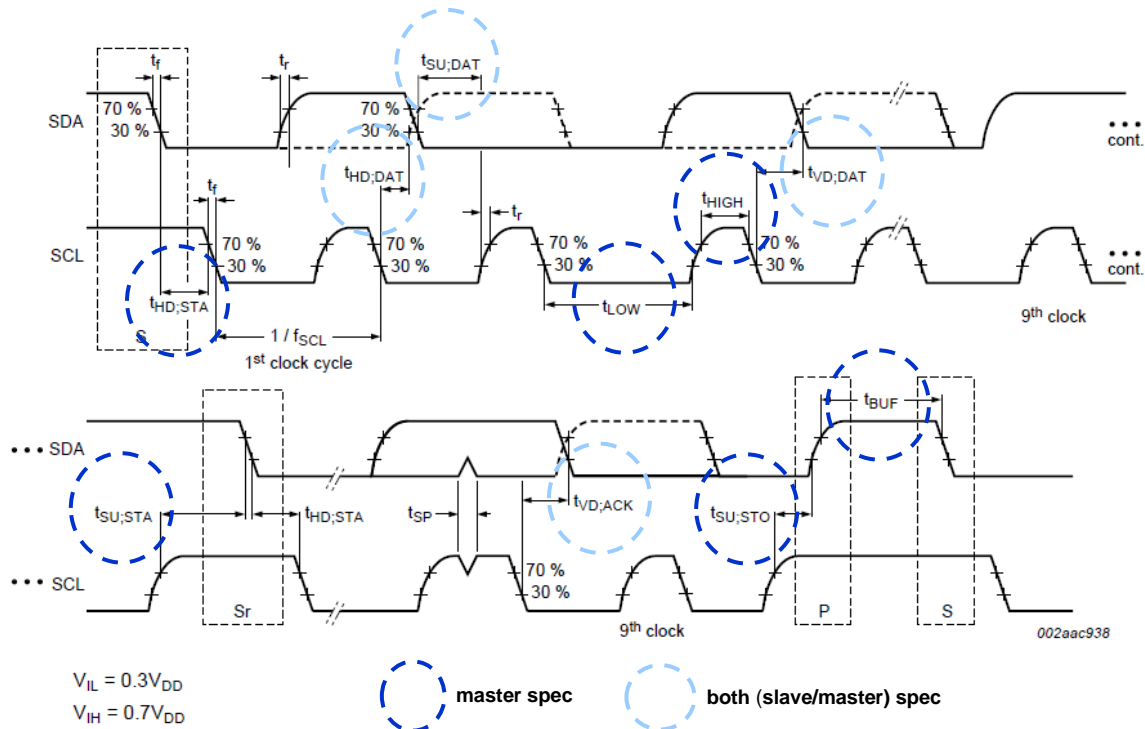

Figure 38. I<sup>2</sup>C Timing Diagram

Table 16. I<sup>2</sup>C Timing Requirements

Parameter	Speed Mode	Value	Unit
$t_{SETUP}$	FM+ (1 MHz)	> 50	nsec
	FM (400 KHz)	> 100	nsec
	SM (100 KHz)	> 250	nsec
$t_{HOLD}$	FM+ (1 MHz)	> 0	nsec
	FM (400 KHz)	> 0	nsec
	SM (100 KHz)	> 0	nsec
$t_{VD:AWK}$	FM+	> 450	nsec
	FM (400 KHz)	> 900	nsec
	SM (100 KHz)	> 3450	nsec
$t_{VD:DAT}$		NA (s-awk + s-data)/(m-awk/s-data)	

## I<sup>2</sup>C Device Address Modes

There are two I<sup>2</sup>C address modes:

- 1) Factory Programmed Mode. The lower 4 bits of the 7-bit device address are set by ordering code as shown in Table 17 below. There are 16 factory programmed addresses available. In this mode, pin 5 is NC and the A0 I<sup>2</sup>C address pin control function is not available.
- 2) A0 Pin Control. This mode allows the user to select between two I<sup>2</sup>C Device addresses as shown in Table 18.

**Table 17. Factory Programmed I<sup>2</sup>C Address Control<sup>[16]</sup>**

I <sup>2</sup> C Address Ordering Code	Device I <sup>2</sup> C Address
0	1100000
1	1100001
2	1100010
3	1100011
4	1100100
5	1100101
6	1100110
7	1100111
8	1101000
9	1101001
A	1101010
B	1101011
C	1101100
D	1101101
E	1101110
F	1101111

**Notes:**

16. Table 17 is only valid for the DCTCXO device option which supports I<sup>2</sup>C Control.

**Table 18. Pin Selectable I<sup>2</sup>C Address Control<sup>[17]</sup>**

A0 Pin 7	A1 Pin 8	I <sup>2</sup> C Address
0	0	1100000
0	1	1100010
1	0	1101000
1	1	1101010 (Default)

**Notes:**

17. Table 18 is only valid for the DCTCXO device option which supports I<sup>2</sup>C control with A0 and A1 Device Address Control Pins.

Schematic Example

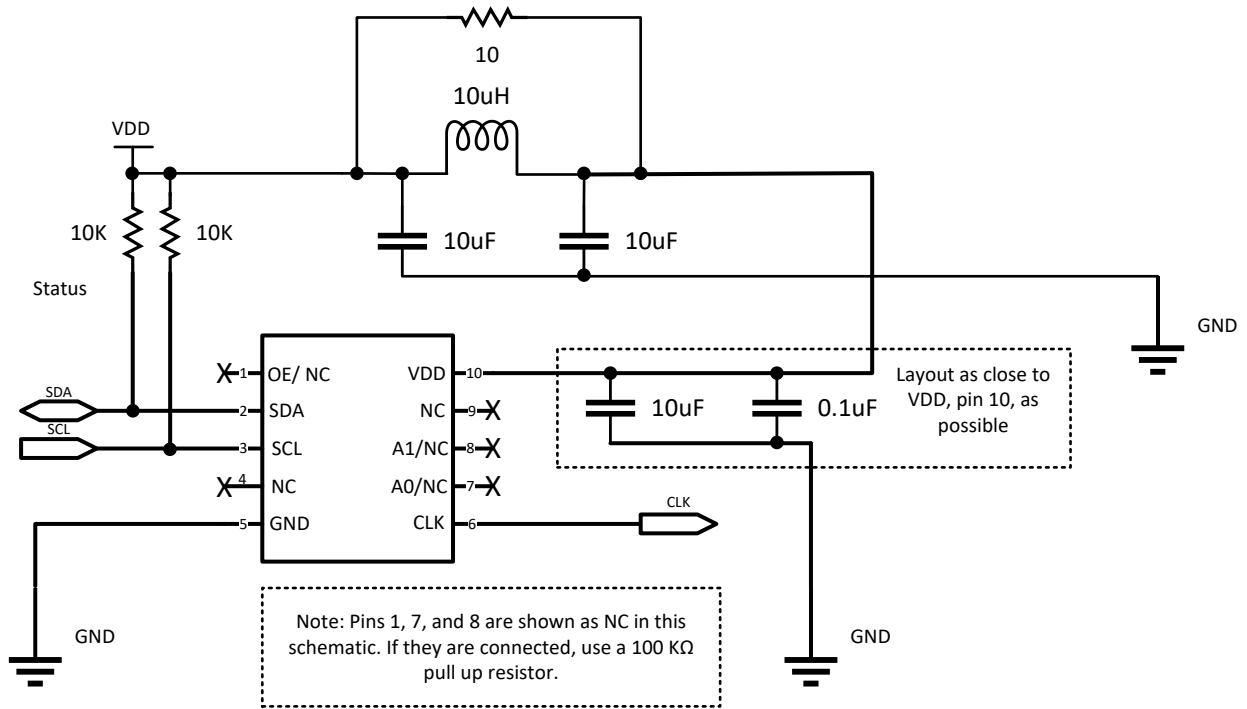

Figure 39. DCTCXO schematic example