

1.5A Low Dropout Voltage Regulator

Adjustable & Fixed Output, Fast Response Time

FEATURES

- Adjustable Output Down To 1.25V
- 1% Output Accuracy
- Output Current of 1.5A
- Low Dropout Voltage of 390mV @ 1.5A
- Extremely Tight Load and Line Regulation
- Extremely Fast Transient Response
- Reverse-Battery Protection
- Zero Current Shutdown (5 pin version)
- Error Flag Signal Output for Out of Regulation State (5 pin version)
- Standard TO-220 and TO-263 Packages

APPLICATIONS

- Powering VGA & Sound Card
- LCD Monitors
- USB Power Supply
- Power PC™ Supplies
- SMPS Post Regulator
- High Efficiency “Green” Computer Systems
- High Efficiency Linear Power Supplies
- Portable Instrumentation
- Constant Current Regulators
- Adjustable Power Supplies
- Battery Charger

Now Available in Lead Free Packaging

Refer to page 8 for pinouts.

DESCRIPTION

The SPX29150/51/52/53 are 1.5A, highly accuracy voltage regulators with a low drop out voltage of 390mV dropout (typical) @ 1.5A. These regulators are specifically designed for low voltage applications that require a low dropout voltage and a fast transient response. They are fully fault protected against over-current, reverse battery, and positive and negative voltage transients. On-Chip trimming adjusts the reference voltage to 1% initial accuracy. Other features in the 5 pin versions include Enable, and Error Flag.

The SPX29150/51/52/53 is offered in 3 & 5-pin TO-220 & TO-263 packages. For a 3A version, refer to the SPX29300 data sheet.

TYPICAL APPLICATION CIRCUIT

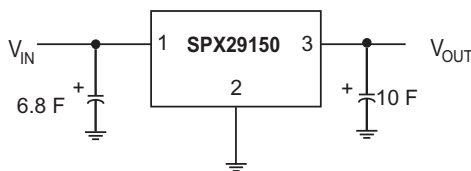

Figure 1. Fixed Output Linear Regulator

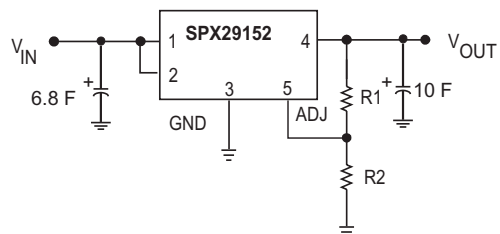

Figure 2. Adjustable Output Linear Regulator

ABSOLUTE MAXIMUM RATINGS

Lead Temperature (soldering, 5 seconds)260°C
 Storage Temperature Range.....-65°C to +150°C
 Operating Junction Temperature Range.....-40°C to +125°C
 Input Voltage (Note 7) 16V

ELECTRICAL CHARACTERISTICS

at $V_{IN}=V_{OUT}+1V$ and $I_{OUT}=10mA$, $C_{IN}=6.8\mu F$, $C_{OUT}=10\mu F$, $T_A=25^\circ C$, unless otherwise specified. The Boldface applies over the junction temperature range. Adjustable versions are set to 5.0V.

| SPX29150/51 | | | | | |
|--|--|-------------------|-----------------------|--------------------------|---------------|
| PARAMETER | CONDITIONS | TYP | MIN | MAX | UNITS |
| Fixed Voltage Options | | | | | |
| 1.8V Version | | | | | |
| Output Voltage | $I_{OUT}=10mA$ $10mA \leq I_{OUT} \leq 1.5A, 2.5V \leq V_{IN} \leq 16V$ | 1.8 1.8 | 1.782 1.764 | 1.818 1.836 | V |
| 2.5V Version | | | | | |
| Output Voltage | $I_{OUT}=10mA$ $10mA \leq I_{OUT} \leq 1.5A, 3.5V \leq V_{IN} \leq 16V$ | 2.5 2.5 | 2.475 2.450 | 2.525 2.550 | V |
| 3.3V Version | | | | | |
| Output Voltage | $I_{OUT}=10mA$ $10mA \leq I_{OUT} \leq 1.5A, 4.3V \leq V_{IN} \leq 16V$ | 3.3 3.3 | 3.267 3.234 | 3.333 3.366 | V |
| 5.0V Version | | | | | |
| Output Voltage | $I_{OUT}=10mA$ $10mA \leq I_{OUT} \leq 1.5A, 6.0V \leq V_{IN} \leq 16V$ | 5.0 5.0 | 4.950 4.900 | 5.050 5.100 | V |
| All Voltage Options | | | | | |
| SPX29150/51/52/53 | | | | | |
| Line Regulation | $I_{OUT}=10mA, (V_{OUT}+1V) \leq V_{IN} \leq 16V$ | 0.1 | | 0.5 | % |
| Load Regulation | $V_{IN}=V_{OUT}+1V, 10mA \leq I_{OUT} \leq I_{FULLLOAD}$ | 0.2 | | 1 | % |
| $\Delta V/\Delta T$ | V_{OUT} Temp Coefficient | 13 | | 100 | ppm/°C |
| Dropout Voltage (Note 1, except 1.8V) | $I_{OUT}=100mA$ $I_{OUT}=750mA$ $I_{OUT}=1.5A$ | 70 230 390 | | 200 600 | mV |
| Ground Current (Note 3) | $I_{OUT}=750mA, V_{IN}=V_{OUT}+1V$ $I_{OUT}=1.5A$ | 12 45 | | 25 | mA |
| Ground Pin Current at Dropout | $V_{IN}=0.1V$ less than specified V_{OUT} , $I_{OUT}=10mA$ | 0.9 | | | mA |
| Current Limit | $V_{OUT}=0V$ (Note 2) | 2.2 | 1.7 | | A |
| Output Noise Voltage (10Hz to 100kHz) | $C_L=10\mu F$ $I_L=100mA$ $C_L=33\mu F$ | 400 260 | | | μV_{RMS} |
| Reference Voltage | Adjustable version only | 1.240 | 1.228 1.215 | 1.252 1.265 | V |
| Reference Voltage | Adjustable version only (Note 8) | | 1.203 | 1.277 | |
| Adjust Pin Bias Current | | 40 | | 80 120 | nA |
| Reference Voltage Temp. Coeff. | (Note 4) | 13 | | | ppm/°C |
| Adjust Pin Bias Current Temp. Coeff. | | 0.1 | | | nA/°C |

ELECTRICAL CHARACTERISTICS

at $V_{IN} = V_{OUT} + 1V$ and $I_{OUT} = 10mA$, $C_{IN} = 6.8\mu F$, $C_{OUT} = 10\mu F$, $T_A = 25^\circ C$, unless otherwise specified. The Boldface applies over the junction temperature range. Adjustable versions are set to 5.0V.

| PARAMETER | CONDITIONS | TYP | MIN | MAX | UNITS |
|--|--|-----------------------------|----------|------------|--------------|
| FLAG OUTPUT (ERROR COMPARATOR) | | SPX29150/29151/29153 | | | |
| Output Leakage Current | $V_{OH} = 16V$ | 0.1 | | 1 2 | μA |
| Output Low Voltage | Device set for 5V, $V_{IN} = 4.5V$, $I_{OL} = 250\mu A$ | 200 | | 300 400 | mV |
| Upper Threshold Voltage | Device set for 5V, (Note 5) | 60 | 40 25 | | mV |
| Lower Threshold Voltage | Device set for 5V, (Note 5) | 75 | | 95 140 | mV |
| Hysteresis | Device set for 5V, (Note 5) | 15 | | | mV |
| ENABLE Input | | SPX29151/29152 | | | |
| Input Logic Voltage Low (OFF) High (ON) | $V_{IN} < 10V$ | | 2.4 | 0.8 | V |
| ENABLE Input Pin | $V_{EN} = 16V$ | 100 | | 600 750 | μA |
| | $V_{EN} = 0.8V$ | | | 1 2 | μA |
| Regulator Output Current in Shutdown | (Note 6) | 10 | | 500 | μA |
| Thermal Resistance | TO-200 Junction to Case, at Tab | 3 | | | $^\circ C/W$ |
| | TO-220 Junction to Ambient | 60 | | | |
| | TO-263 Junction to Case, at Tab | 3 | | | |
| | TO-263 Junction to Ambient | 60 | | | |

NOTES:

Note 1: Dropout voltage is defined as the input to output differential when the output voltage drops to 99% of its nominal value.

Note 2: $V_{IN} = V_{OUT} (NOMINAL) + 1V$. For example, use $V_{IN} = 4.3V$ for a 3.3V regulator. Employ pulse-testing procedures to minimize temperature rise.

Note 3: Ground pin current is the regulator quiescent current. The total current drawn from the source is the sum of the load current to the ground current.

Note 4: Thermal regulation is defined as the change in the output voltage at a time T after a change in power dissipation is applied, excluding load or line regulation effects.

Note 5: Comparator threshold is expressed in terms of a voltage differential at the Adjust terminal below the nominal reference voltage measured 6V input. To express these thresholds in terms of output voltage change, multiply the error amplifier gain = $V_{OUT}/V_{REF} = (R1 + R2)/R2$. For example, at a programmable output voltage of 5V, the Error output is guaranteed to go low when the output drops by $95mV \times 5V / 1.240V = 38mV$. Threshold remain constant as a percent of V_{OUT} as V_{OUT} is varied, with the dropout warning occurring at typically 5% below nominal, 7.7% guaranteed.

Note 6: $V_{EN} \leq 0.8V$ and $V_{IN} \leq 16V$, $V_{OUT} = 0$.

Note 7: Maximum positive supply voltage of 20V must be of limited duration ($< 100m_s$) $< 1\%$. The maximum continuous supply voltage is 16V.

Note 8: $V_{REF} \leq V_{OUT} \leq (V_{IN} - 1)$, $2.5V \leq V_{IN} \leq 16V$, $10mA \leq I_L \leq I_{FL}$, $T_J < T_{Jmax}$.

BLOCK DIAGRAM

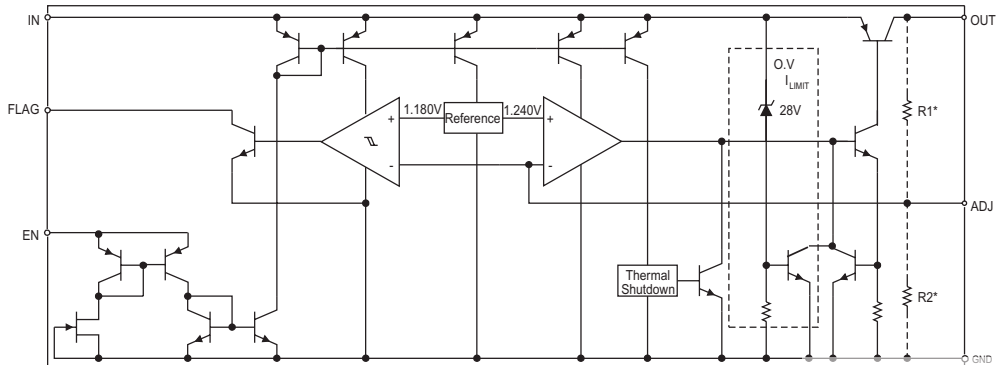

TYPICAL PERFORMANCE CHARACTERISTICS

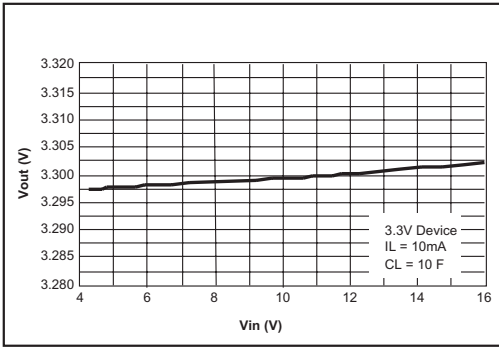

Figure 3. Line Regulation

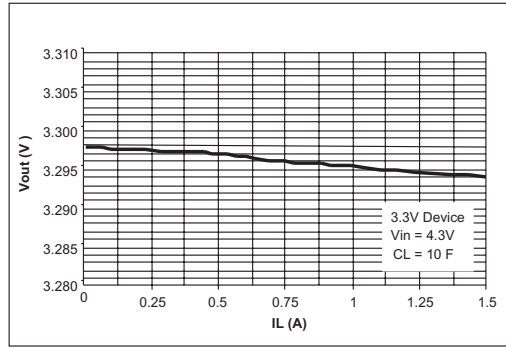

Figure 4. Load Regulation

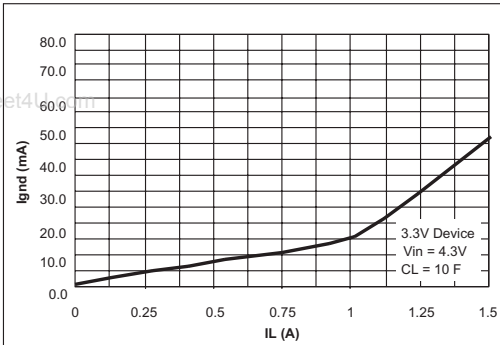

Figure 5. Ground Current vs Load Current

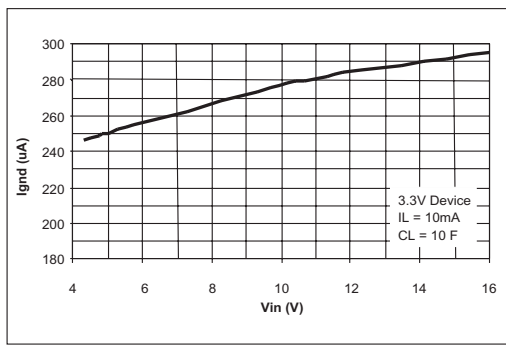

Figure 6. Ground Current vs Input Voltage

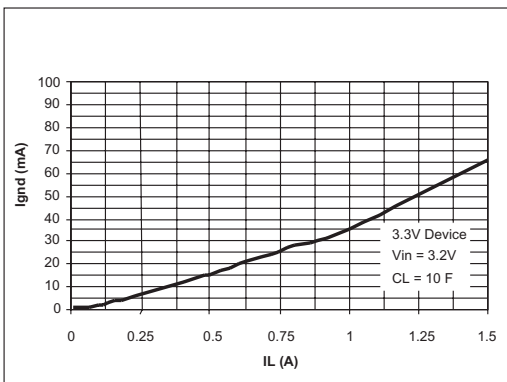

Figure 7. Ground Current vs Load Current in Dropout

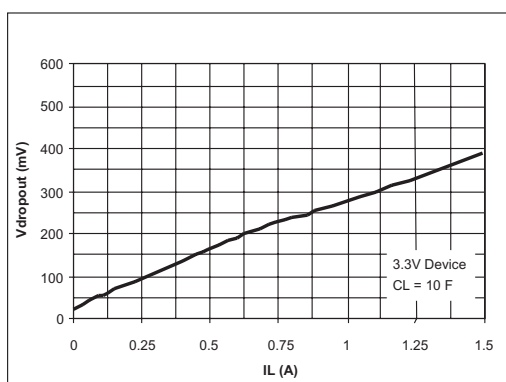

Figure 8. Dropout Voltage vs Load Current

TYPICAL PERFORMANCE CHARACTERISTICS

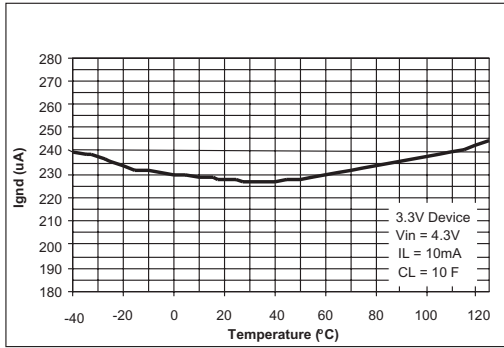

Figure 9. Ground Current vs Temperature at $I_{LOAD}=10mA$

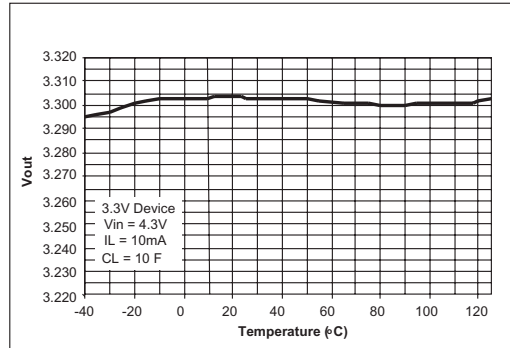

Figure 10. Output Voltage vs Temperature at $I_{LOAD}=10mA$

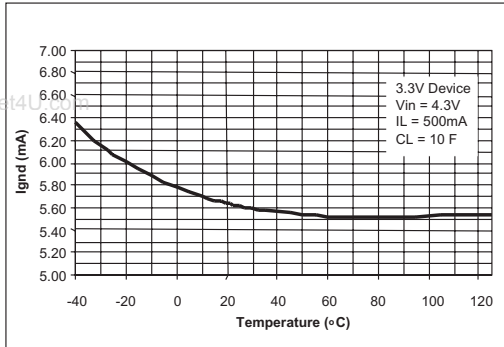

Figure 11. Ground Current vs Temperature at $I_{LOAD}=500mA$

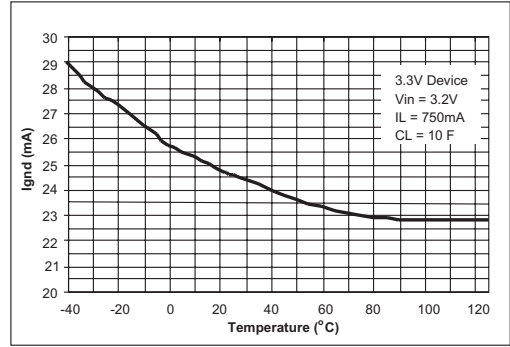

Figure 12. Output Voltage vs Temperature in Dropout at $I_{LOAD}=750mA$

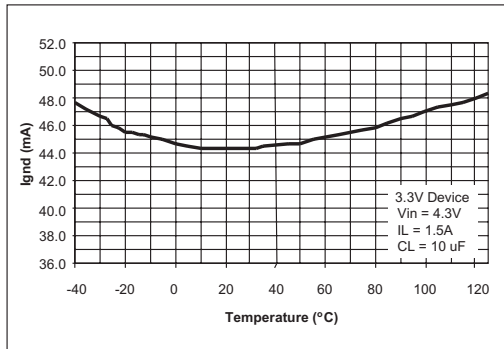

Figure 13. Ground Current vs Temperature at $I_{LOAD}=1.5A$

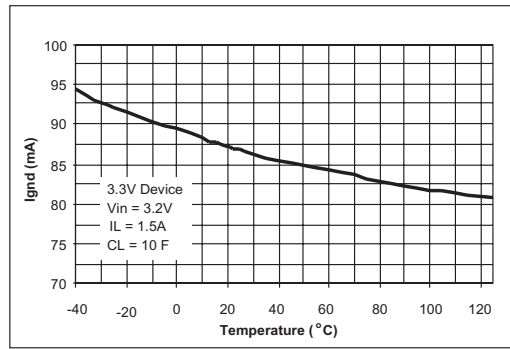

Figure 14. Output Current vs Temperature in Dropout at $I_{LOAD}=1.5A$

TYPICAL PERFORMANCE CHARACTERISTICS

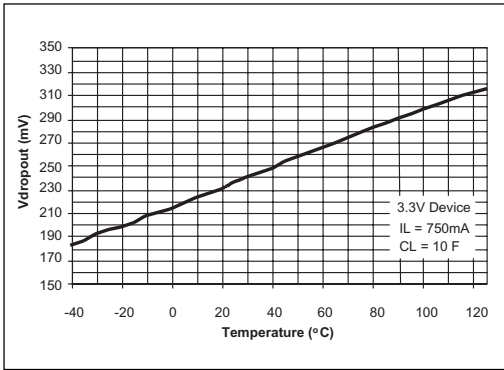

Figure 15. Dropout Voltage vs Temperature at $I_{LOAD} = 750mA$

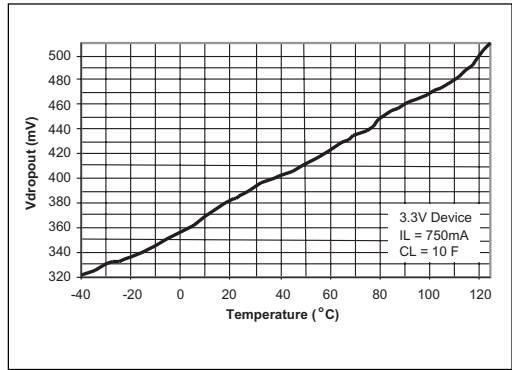

Figure 16. Dropout Voltage vs Temperature at $I_{LOAD} = 1.5A$

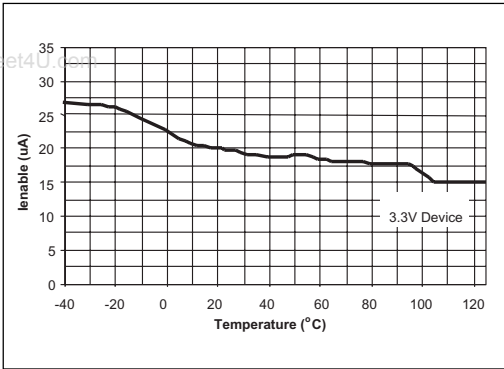

Figure 17. ENABLE Current vs Temperature at $V_{EN} = 16V$

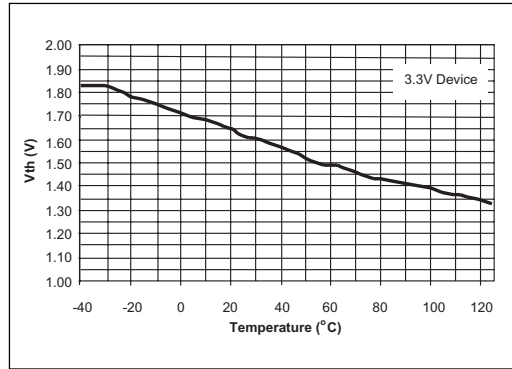

Figure 18. ENABLE Threshold vs Temperature

The SPX29150/51/52/53 incorporates protection against over-current faults, reversed load insertion, over temperature operation, and positive and negative transient voltage.

Thermal Considerations

Although the SPX29150/51/52/53 offers limiting circuitry for overload conditions, it is still necessary to insure that the maximum junction temperature is not exceeded in the application. Heat will flow through the lowest resistance path, the junction-to-case path. In order to insure the best thermal flow of the component, proper mounting is required. Consult the heatsink manufacturer for thermal resistance and heat sink design.

TO-220 Design Example:

Assume that $V_{IN} = 10V$, $V_{OUT} = 5V$, $I_{OUT} = 1.5A$, $T_A = 50^{\circ}C$, $\theta_{HA} = 1^{\circ}C/W$, $\theta_{CH} = 2^{\circ}C/W$, and $\theta_{JC} = 3^{\circ}C/W$, where:

- T_A = ambient temperature,
- θ_{HA} = heatsink to ambient thermal resistance
- θ_{CH} = case to heatsink thermal resistance
- θ_{JC} = junction to case thermal resistance

The power calculated under these conditions is:

$$P_D = (V_{IN} - V_{OUT}) * I_{OUT} = 7.5W.$$

And the junction temperature is calculated as

$$T_J = T_A + P_D * (\theta_{HA} + \theta_{CH} + \theta_{JC}) \text{ or}$$

$$T_J = 50 + 7.5 * (1+2+3) = 95^{\circ}C$$

Reliable operation is insured.

Capacitor Requirements

The output capacitor is needed to insure stability and minimize the output noise. The value of the capacitor varies with the load. However, a minimum value of 10 μ F aluminum capacitor will guarantee stability over all load conditions. A tantalum capacitor is recommended if a faster load transient response is needed. If the power source has a high AC impedance, a 0.1 μ F ceramic capacitor between input & ground is recommended.

Minimum Load Current

To ensure a proper behavior of the regulator under light load, a minimum load of 5mA for SPX29150/51/52/53 is required.

Typical Application Circuits

Figure 19 represents a typical fixed output regulator. Figure 20 represents an adjustable regulator. The values of R1 and R2 set the output voltage value as follows: $V_{OUT} = V_{REF} * [1 + (R1/R2)]$. For best results, the total series resistance should be small enough to pass a minimum regulator load current of 5mA. A minimum value of 10k Ω is recommended for R2 with a range between 10k Ω and 47k Ω .

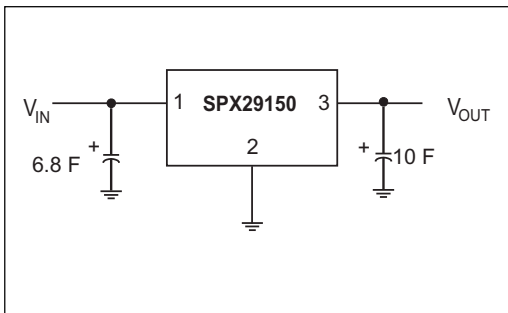

Figure 19. Fixed Output Linear Regulator

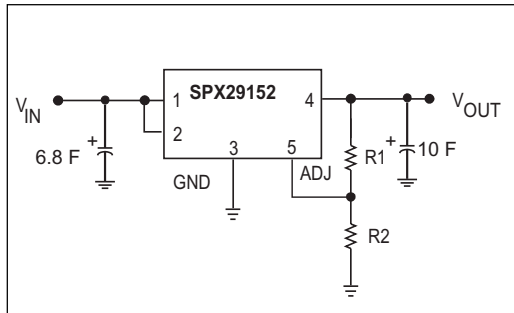
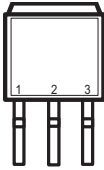

Figure 20. Adjustable Output Linear Regulator

TO-263-3 Package (T)



V_{IN} GND V_{OUT}
Front View

TO-263-5 Package (T5)

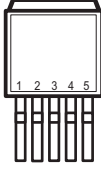

Top View

| SPX29151 | SPX29152 | SPX29153 |
|-----------|-----------|-----------|
| 1) ENABLE | 1) ENABLE | 1) FLAG |
| 2) INPUT | 2) INPUT | 2) INPUT |
| 3) GND | 3) GND | 3) GND |
| 4) OUTPUT | 4) OUTPUT | 4) OUTPUT |
| 5) FLAG | 5) ADJUST | 5) ADJUST |

TO-220-3 Package (U)

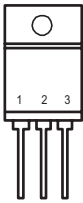

V_{IN} GND V_{OUT}
Front View

TO-220-5 Package (U5)

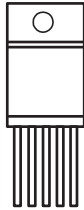

Top View

| SPX29151 | SPX29152 | SPX29153 |
|-----------|-----------|-----------|
| 1) ENABLE | 1) ENABLE | 1) FLAG |
| 2) INPUT | 2) INPUT | 2) INPUT |
| 3) GND | 3) GND | 3) GND |
| 4) OUTPUT | 4) OUTPUT | 4) OUTPUT |
| 5) FLAG | 5) ADJUST | 5) ADJUST |

*Tab is internally connected to GND

www.DataSheet4U.com

ORDERING INFORMATION

| PART NUMBER | ACCURACY | OUTPUT VOLTAGE | PACKAGE |
|--------------------|-----------------|-----------------------|----------------|
| SPX29150U-1.8 | 1.0% | 1.8V | 3 lead TO-220 |
| SPX29150U-2.5 | 1.0% | 2.5V | 3 lead TO-220 |
| SPX29150U-3.3 | 1.0% | 3.3V | 3 lead TO-220 |
| SPX29150U-5.0 | 1.0% | 5.0V | 3 lead TO-220 |
| SPX29150T-1.8 | 1.0% | 1.8V | 3 lead TO-263 |
| SPX29150T-1.8/TR | 1.0% | 1.8V | 3 lead TO-263 |
| SPX29150T-2.5 | 1.0% | 2.5V | 3 lead TO-263 |
| SPX29150T-2.5/TR | 1.0% | 2.5V | 3 lead TO-263 |
| SPX29150T-3.3 | 1.0% | 3.3V | 3 lead TO-263 |
| SPX29150T-3.3/TR | 1.0% | 3.3V | 3 lead TO-263 |
| SPX29150T-5.0 | 1.0% | 5.0V | 3 lead TO-263 |
| SPX29150T-5.0/TR | 1.0% | 5.0V | 3 lead TO-263 |
| SPX29151U5-1.8 | 1.0% | 1.8V | 5 lead TO-220 |
| SPX29151U5-2.5 | 1.0% | 2.5V | 5 lead TO-220 |
| SPX29151U5-3.3 | 1.0% | 3.3V | 5 lead TO-220 |
| SPX29151U5-5.0 | 1.0% | 5.0V | 5 lead TO-220 |
| SPX29151T5-1.8 | 1.0% | 1.8V | 5 lead TO-263 |
| SPX29151T5-1.8/TR | 1.0% | 1.8V | 5 lead TO-263 |
| SPX29151T5-2.5 | 1.0% | 2.5V | 5 lead TO-263 |
| SPX29151T5-2.5/TR | 1.0% | 2.5V | 5 lead TO-263 |
| SPX29151T5-3.3 | 1.0% | 3.3V | 5 lead TO-263 |
| SPX29151T5-3.3/TR | 1.0% | 3.3V | 5 lead TO-263 |
| SPX29151T5-5.0 | 1.0% | 5.0V | 5 lead TO-263 |
| SPX29151T5-5.0/TR | 1.0% | 5.0V | 5 lead TO-263 |
| SPX29152T5 | 1.0% | Adj | 5 lead TO-263 |
| SPX29152T5/TR | 1.0% | Adj | 5 lead TO-263 |
| SPX29152U5 | 1.0% | Adj | 5 lead TO-220 |
| SPX29153T5 | 1.0% | Adj | 5 lead TO-263 |
| SPX29153T5/TR | 1.0% | Adj | 5 lead TO-263 |
| SPX29153U5 | 1.0% | Adj | 5 lead TO-220 |

Available in lead free packaging. To order add "-L" suffix to part number.

Example: SPX29153T5/TR = standard; SPX29153T5-L/TR = lead free



ANALOG EXCELLENCE

Sipex Corporation

**Headquarters and
Sales Office**
233 South Hillview Drive
Milpitas, CA 95035
TEL: (408) 934-7500
FAX: (408) 935-7600

Sipex Corporation reserves the right to make changes to any products described herein. Sipex does not assume any liability arising out of the application or use of any product or circuit described herein; neither does it convey any license under its patent rights nor the rights of others.

www.DataSheet4U.com