

CG2H40035

35 W, DC - 6 GHz, RF Power GaN HEMT

Description

WolfSpeed's CG2H40035 is an unmatched, gallium nitride (GaN) high electron mobility transistor (HEMT). The CG2H40035, operating from a 28 volt rail, offers a general purpose, broadband solution to a variety of RF and microwave applications. GaN HEMTs offer high efficiency, high gain and wide bandwidth capabilities making the CG2H40035 ideal for linear and compressed amplifier circuits. The transistor is available in both a screw-down, flange package and solder-down, pill package.

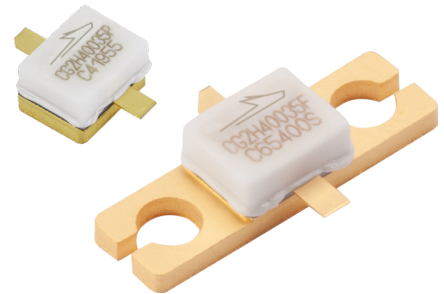

Package Types: 440196 & 440166
PNs: CG2H40035P & CG2H40035F

Features

- Up to 6 GHz Operation
- 40 W typical P_{SAT}
- 64% Efficiency at P_{SAT}
- 14 dB Small Signal Gain at 3.5 GHz
- 28 V Operation

Applications

- 2-Way Private Radio
- Broadband Amplifiers
- Cellular Infrastructure
- Test Instrumentation
- Class A, AB, Linear amplifiers suitable for OFDM, W-CDMA, EDGE, CDMA waveforms



Large Signal Models Available for ADS and MWO





Absolute Maximum Ratings (not simultaneous) at 25°C Case Temperature

Parameter	Symbol	Rating	Units	Conditions
Drain-Source Voltage	V_{DSS}	120	V_{DC}	25°C
Gate-to-Source Voltage	V_{GS}	-10, +2		
Storage Temperature	T_{STG}	-65, +150	°C	
Operating Junction Temperature	T_J	225		
Maximum Forward Gate Current	I_{GMAX}	12	mA	25°C
Maximum Drain Current ¹	I_{DMAX}	4.5		
Soldering Temperature ²	T_S	245	°C	
Screw Torque	τ	40	in-oz	
Thermal Resistance, Junction to Case (packaged) ³	$R_{\theta JC}$	3.4	°C/W	85°C
Case Operating Temperature ^{3,4}	T_C	-40, +85	°C	

Notes:

¹ Current limit for long term, reliable operation

² Eutectic die attach using 80/20 AuSn mounted to a 60 mil thick CuMoCu carrier

³ Measured for the CG2H40035F at $P_{DISS} = 42 W$

⁴ See also, the Power Dissipation De-rating Curve on Page 10

Electrical Characteristics ($T_C = 25^\circ C$)

Characteristics	Symbol	Min.	Typ.	Max.	Units	Conditions
DC Characteristics¹						
Gate Threshold Voltage	$V_{GS(th)}$	-3.8	-3.1	-2.3	V	$V_{DS} = 10 V, I_D = 10.8 mA$
Gate Quiescent Voltage	$V_{GS(Q)}$	—	-2.7	—		$V_{DS} = 28 V, I_D = 500 mA$
Saturated Drain Current	I_{DS}	7.8	10.8	—	A	$V_{DS} = 6.0 V, V_{GS} = 2.0 V$
Drain-Source Breakdown Voltage	V_{BR}	84	—	—	V	$V_{GS} = -8 V, I_D = 10.8 mA$
RF Characteristics² ($T_C = 25^\circ C, F_0 = 3.5 GHz$ unless otherwise noted)						
Small Signal Gain	G_{SS}	13.5	14.5	—	dB	$V_{DD} = 28 V, I_{DQ} = 500 mA$
Output Power ³	P_{SAT}	28	40	—		
Drain Efficiency ⁴	η	59	65	—	%	$V_{DD} = 28 V, I_{DQ} = 500 mA, P_{SAT} = 40 W$
Output Mismatch Stress	VSWR	—	—	10 : 1	Y	No damage at all phase angles, $V_{DD} = 28 V, I_{DQ} = 500 mA, P_{OUT} = 40 W CW$
Dynamic Characteristics						
Input Capacitance	C_{GS}	—	15.4	—	pF	$V_{DS} = 28 V, V_{GS} = -8 V, f = 1 MHz$
Output Capacitance	C_{DS}	—	3.0	—		
Feedback Capacitance	C_{GD}	—	0.7	—		

Notes:

¹ Measured on wafer prior to packaging

² Measured in CG2H40035F-AMP

³ P_{SAT} is defined as $I_C > 0.1 mA$

⁴ Drain Efficiency = P_{OUT} / P_{DC}



Typical Performance

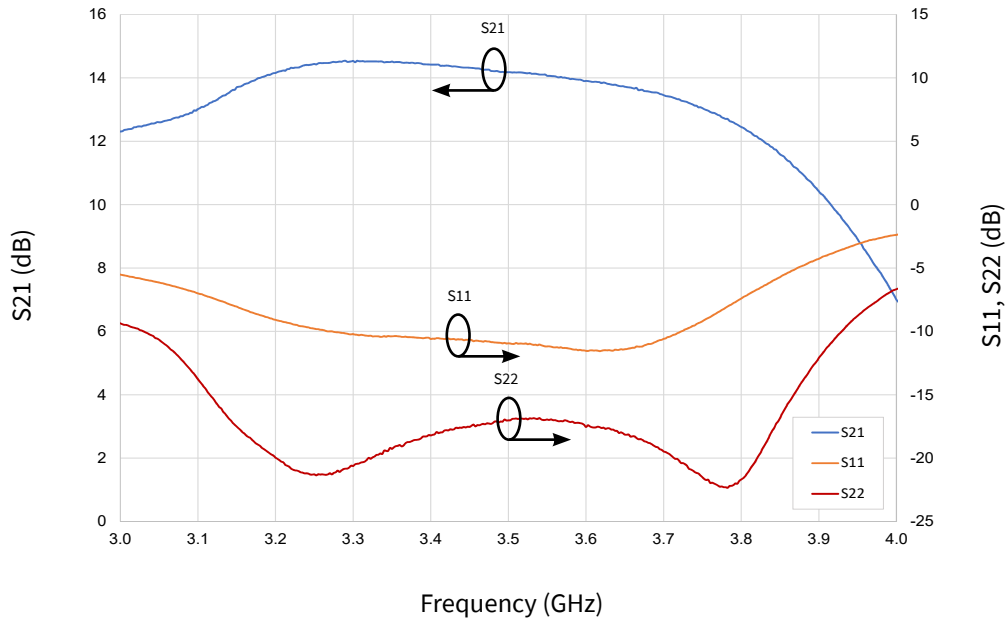

Figure 1. Small Signal Gain and Return Loss vs. Frequency
 $V_{DD} = 28\text{ V}$, $I_{DQ} = 500\text{ mA}$

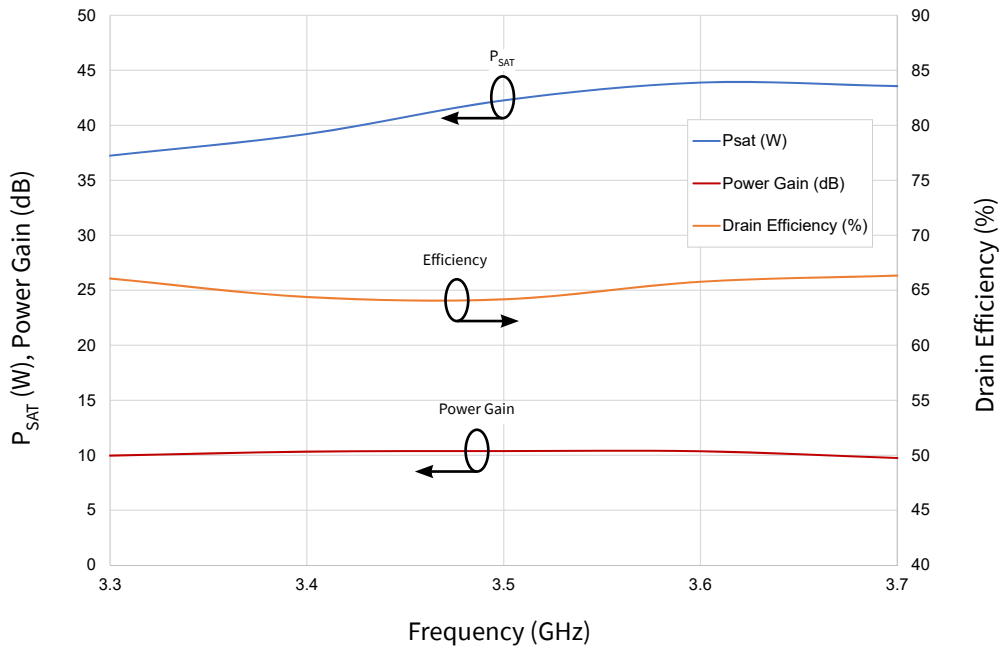

Figure 2. P_{SAT} Power Gain, and Drain Efficiency vs. Frequency
 $V_{DD} = 28\text{ V}$, $I_{DQ} = 500\text{ mA}$



Typical Performance

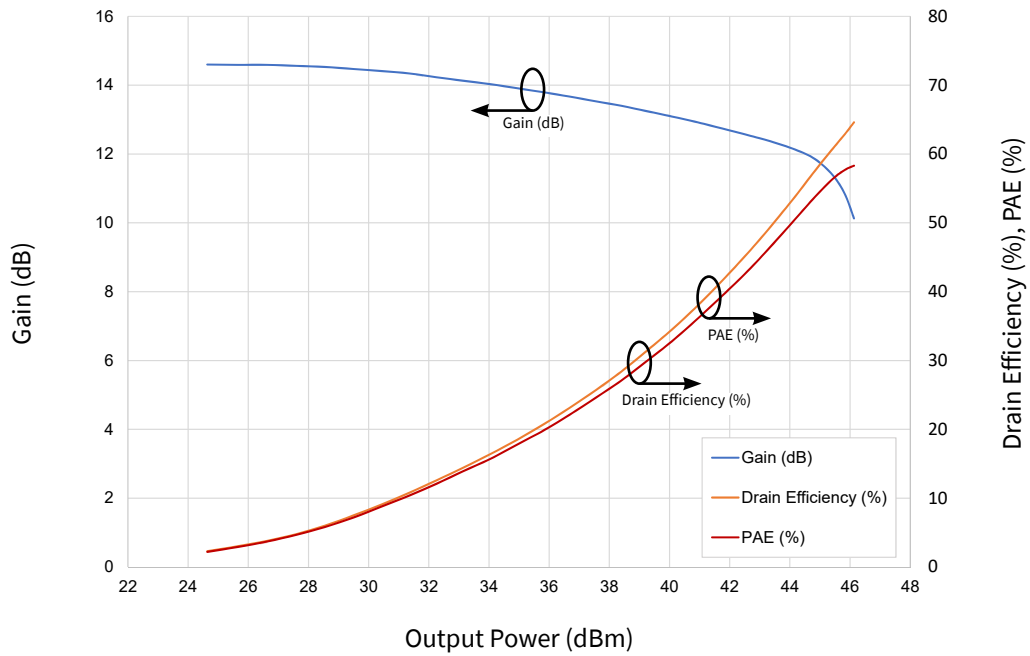

Figure 3. Swept Data vs. Output Power
 $V_{DD} = 28\text{ V}$, $I_{DQ} = 500\text{ mA}$, Freq = 3.5 GHz

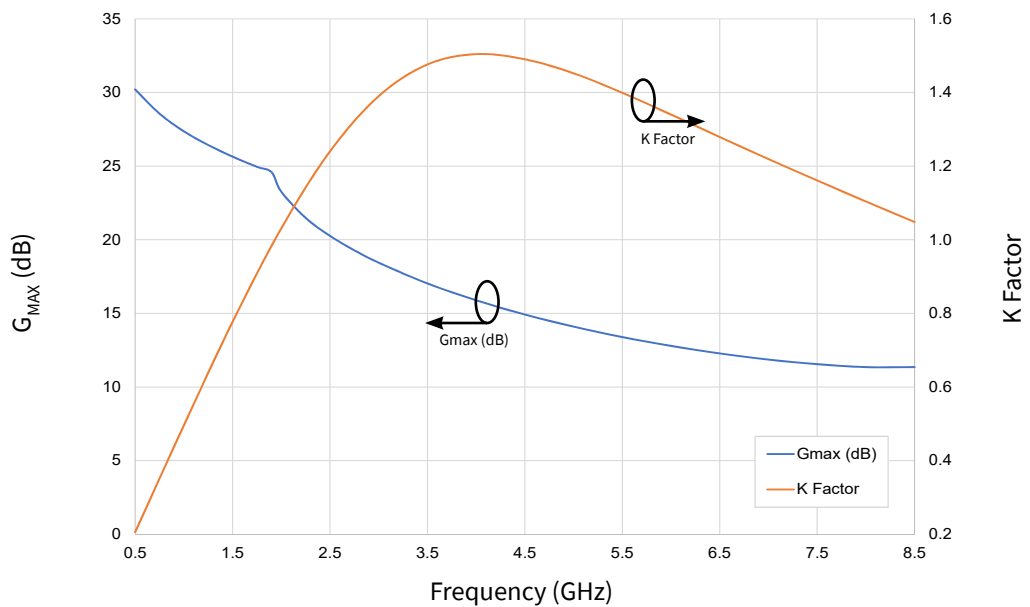

Figure 4. Simulated Maximum Available Gain and K Factor
 $V_{DD} = 28\text{ V}$, $I_{DQ} = 500\text{ mA}$

Typical Noise Performance

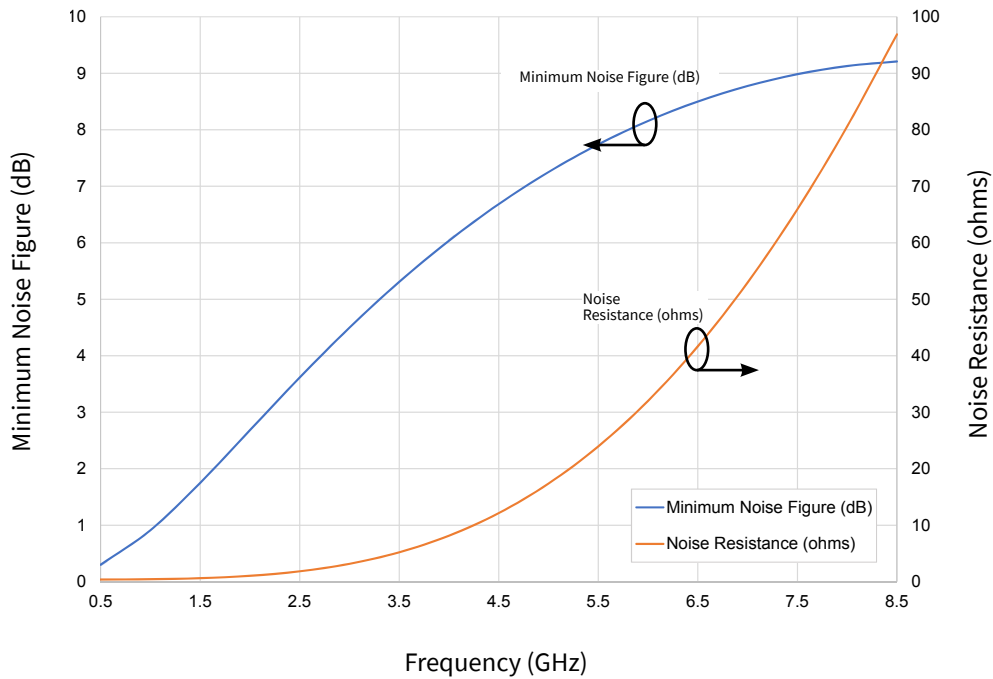

Figure 5. Simulated Minimum Noise Figure and Noise Resistance vs. Frequency
 $V_{DD} = 28\text{ V}$, $I_{DQ} = 500\text{ mA}$

Electrostatic Discharge (ESD) Classifications

Parameter	Symbol	Class	Classification Level	Test Methodology
Human Body Model	HBM	1A	ANSI/ESDA/JEDEC JS-001 Table 3	JEDEC JESD22 A114-D
Charge Device Model	CDM	C3	ANSI/ESDA/JEDEC JS-002 Table 3	JEDEC JESD22 C101-C



Typical Performance of the CG2H40035F-AMP1

Test conditions unless otherwise noted: CW Data, $V_{DD} = 28\text{ V}$, $I_{DQ} = 200\text{ mA}$, $T_{CASE} = +25\text{ }^{\circ}\text{C}$, $P_{IN} = 33\text{ dBm}$

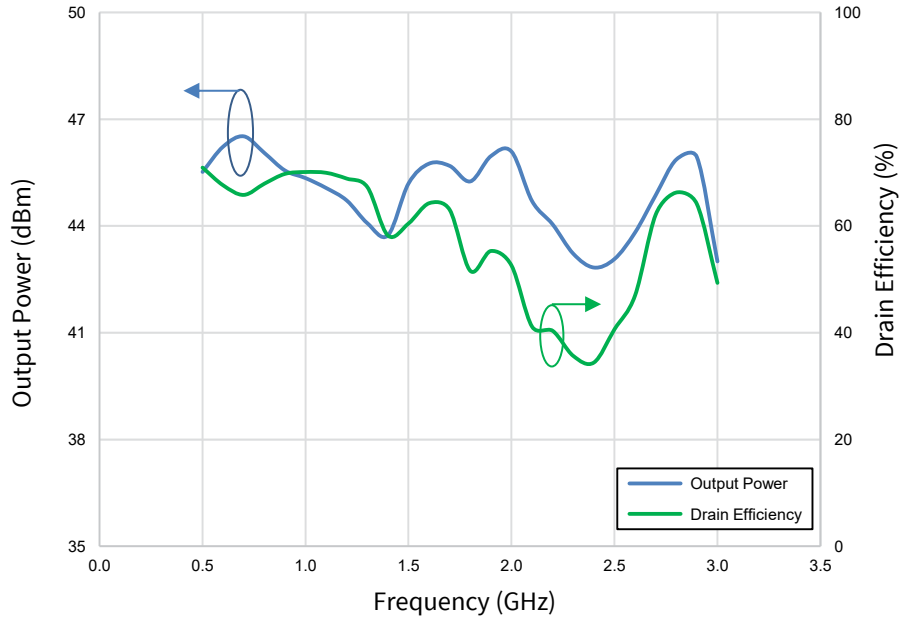

Figure 6. Output Power and Drain Efficiency vs. Frequency

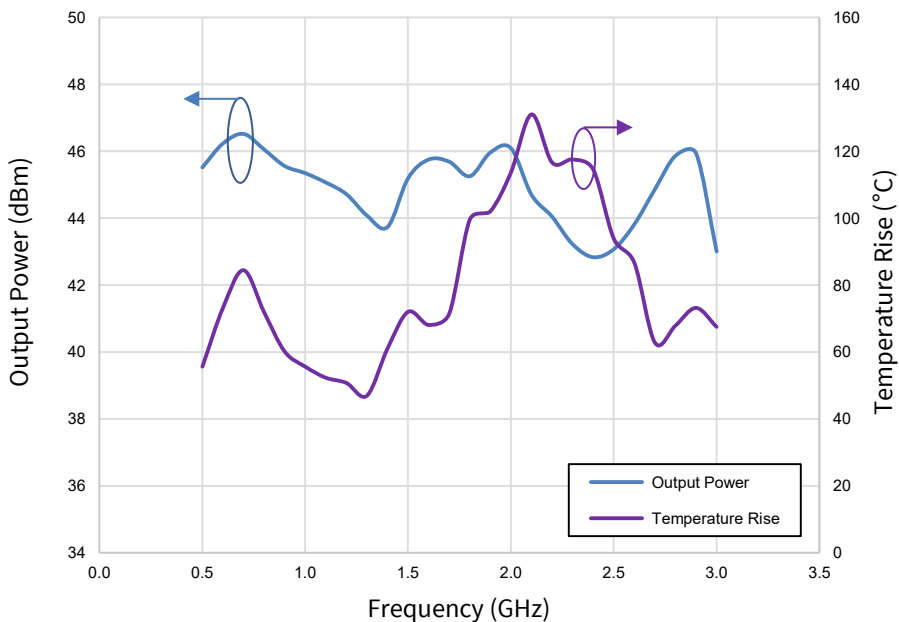

Figure 7. Output Power and Temperature Rise vs. Frequency



Typical Performance of the CG2H40035F-AMP1

Test conditions unless otherwise noted: CW Data, $V_{DD} = 28\text{ V}$, $I_{DQ} = 200\text{ mA}$

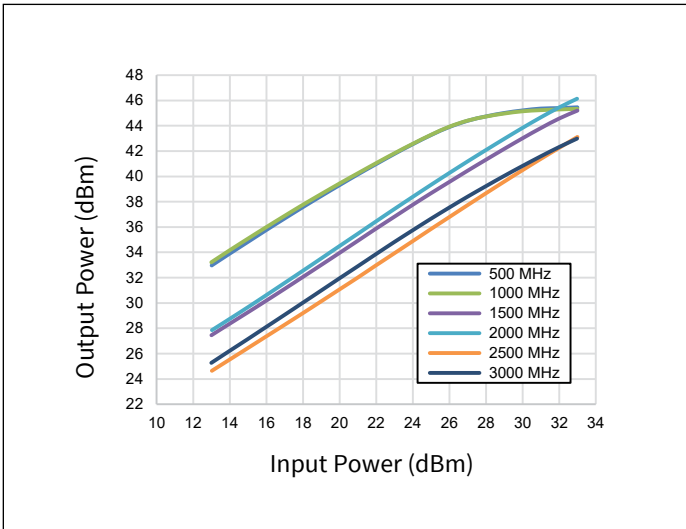

Figure 8. Output Power vs. Input Power as a Function of Frequency

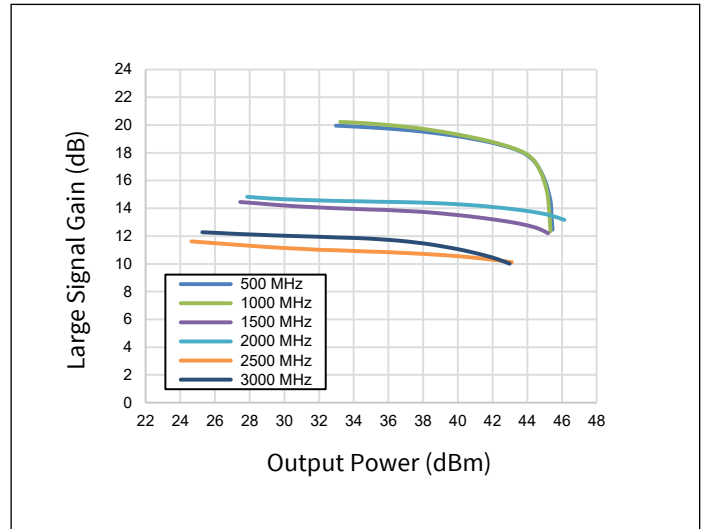

Figure 9. Large Signal Gain vs. Output Power as a Function of Frequency

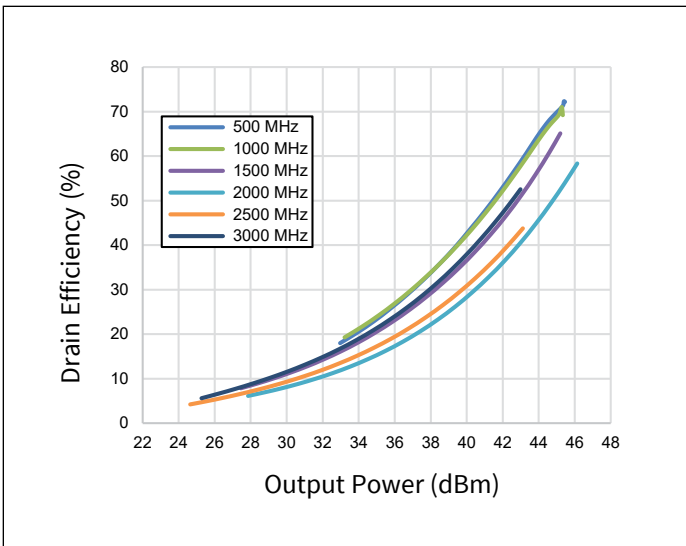

Figure 10. Drain Efficiency vs. Output Power as a Function of Frequency

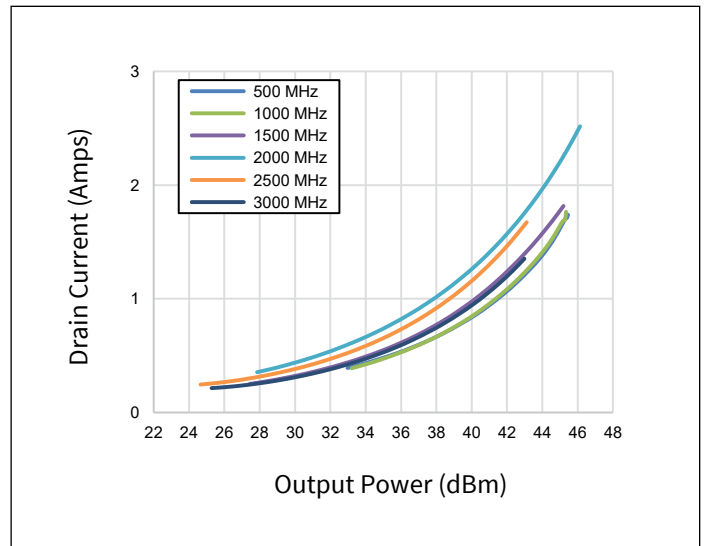

Figure 11. Drain Current vs. Output Power as a Function of Frequency

Typical Performance of the CG2H40035F-AMP1

Test conditions unless otherwise noted: CW Data, $V_{DD} = 28\text{ V}$, $I_{DQ} = 200\text{ mA}$, $P_{IN} = 33\text{ dBm}$

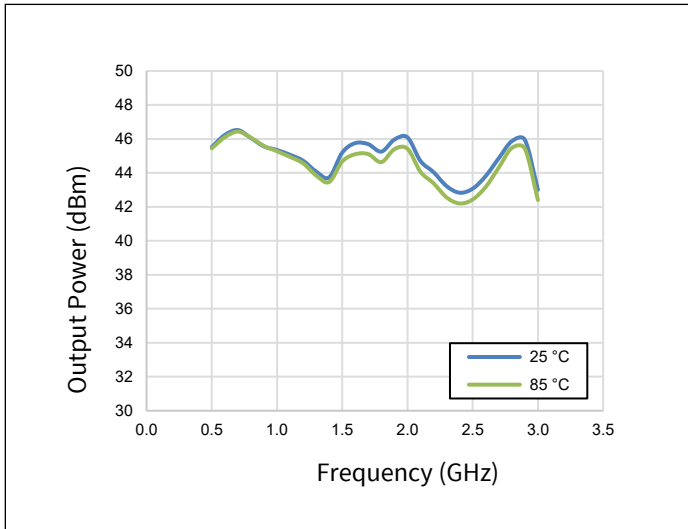

Figure 12. Output Power vs. Frequency as a Function of Temperature

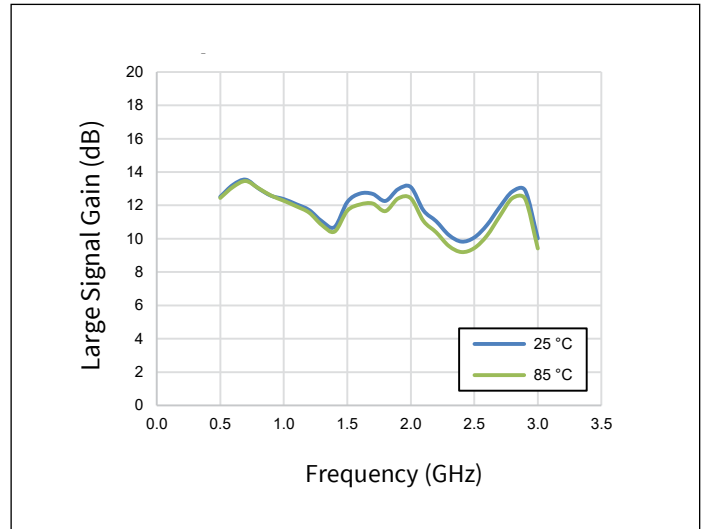

Figure 13. Large Signal Gain vs. Frequency as a Function of Temperature

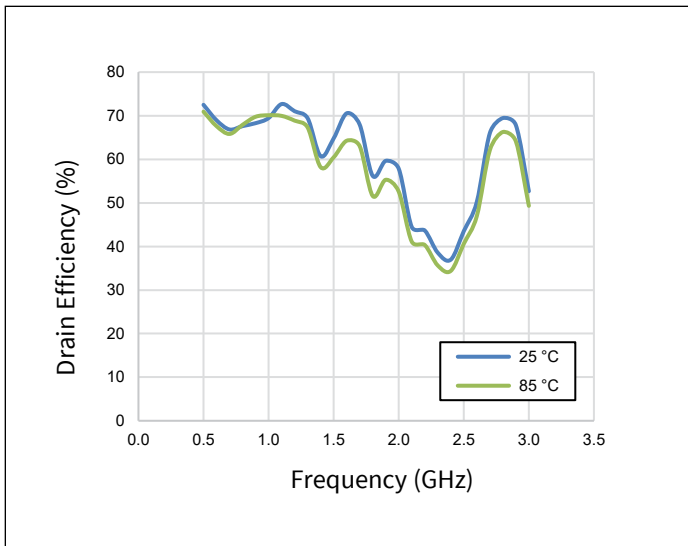

Figure 14. Drain Efficiency vs. Frequency as a Function of Temperature

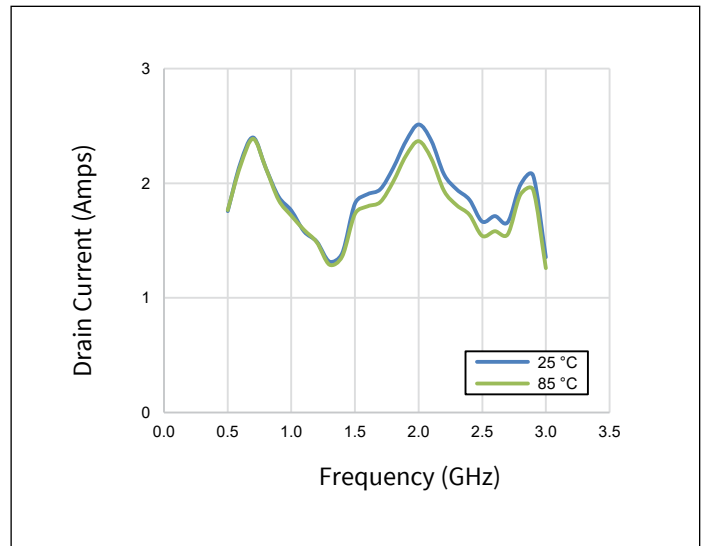

Figure 15. Drain Current vs. Frequency as a Function of Temperature



Typical Performance of the CG2H40035F-AMP1

Test conditions unless otherwise noted: Two-tone Data, $V_{DD} = 28\text{ V}$, $I_{DQ} = 260\text{ mA}$, Tone Spacing = 1 MHz

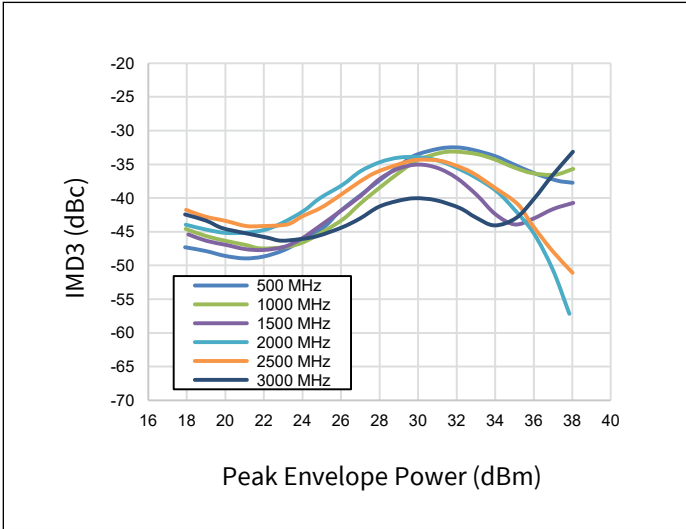

Figure 16. IMD3 vs. Peak Envelop Power as a Function of Frequency

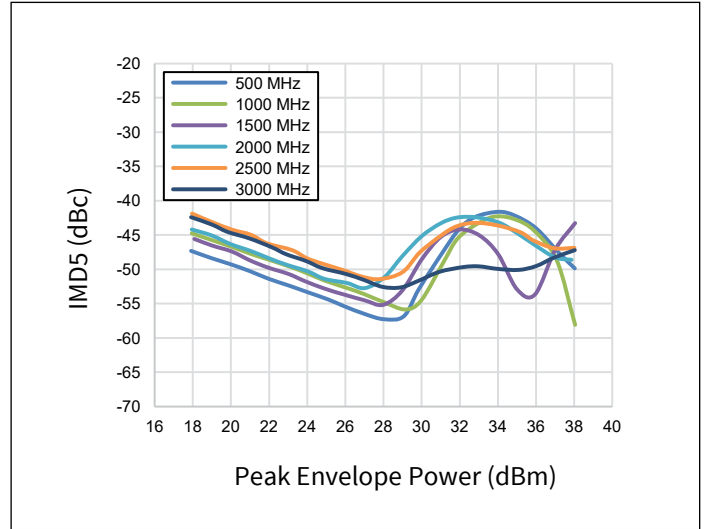

Figure 17. IMD5 vs. Peak Envelop Power as a Function of Frequency

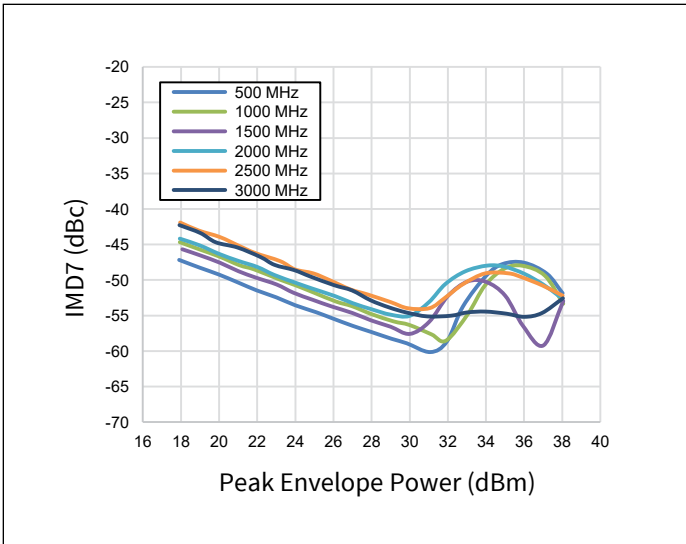
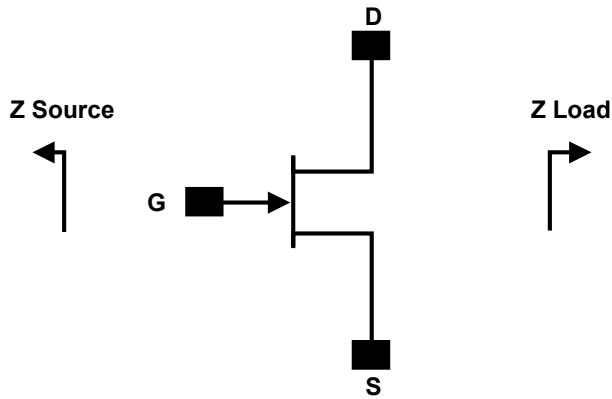

Figure 18. IMD7 vs. Peak Envelop Power as a Function of Frequency



Source and Load Impedances



Frequency (MHz)	Z Source	Z Load
500	4.212 + j5.822	10.547 + j3.155
1000	3.536 + j2.811	7.281 + j2.996
1500	1.468 + j1.554	5.530 + j0.839
2500	1.326 - j3.115	5.221 - j3.508
3500	1.648 - j6.926	4.309 - j7.717

Notes:

¹ $V_{DD} = 28\text{ V}$, $I_{DQ} = 500\text{ mA}$, in the 440166/440196 package

² Optimized for P_{SAT} and PAE

³ When using this device at low frequency, series resistors should be used to maintain amplifier stability

CG2H40035 Power Dissipation De-rating Curve

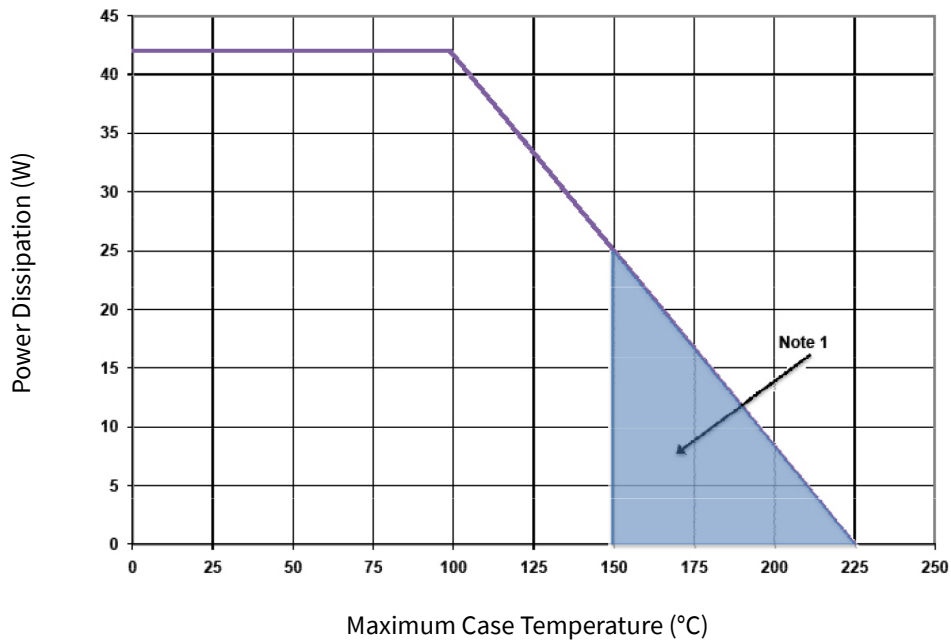

Note:

¹ Area exceeds Maximum Case Operating Temperature (See Page 2)



CG2H40035F-AMP Demonstration Amplifier Circuit Schematic

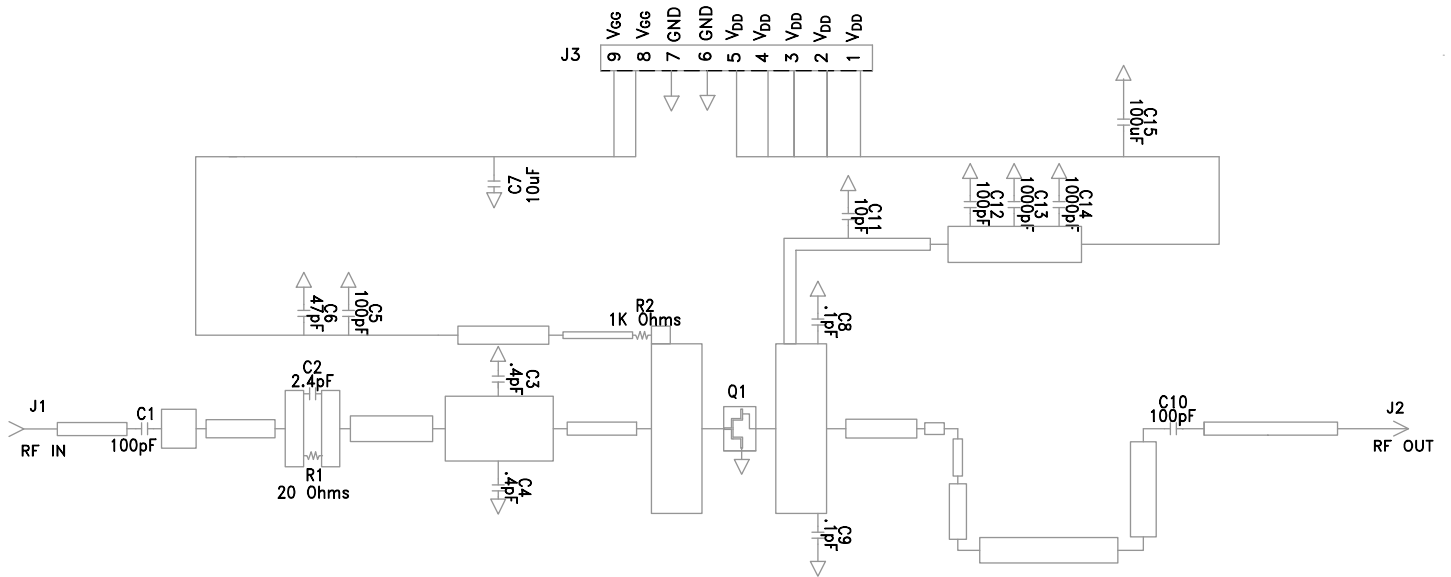

CG2H40035F-AMP Demonstration Amplifier Circuit Outline

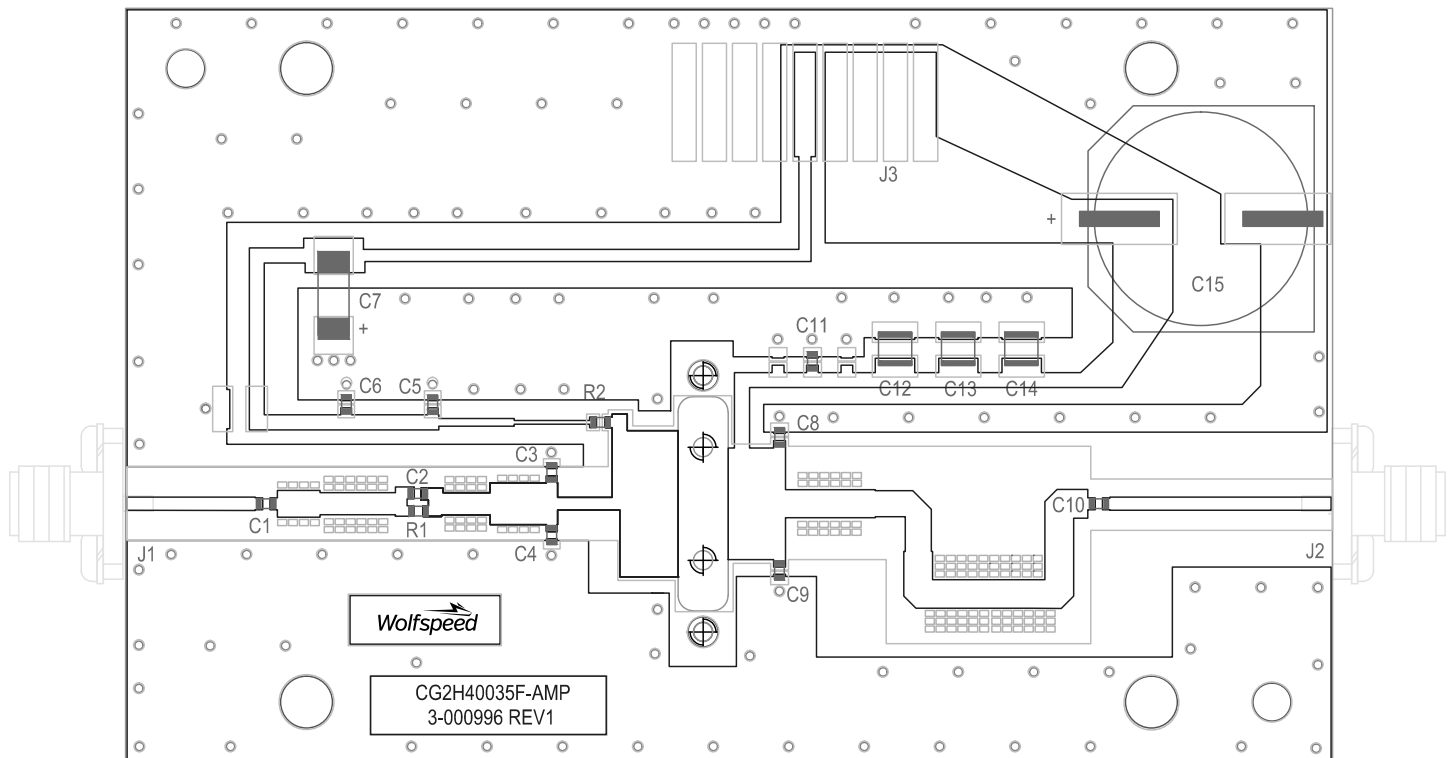



CG2H40035F-AMP Demonstration Amplifier Circuit Bill of Materials

Designator	Description	Qty
C1, C5, C10	CAP, 100 pF, +/-5%, ATC600s SERIES	2
C2	CAP, 2.4pF, +/-0.1pF, 0603, ATC	1
C3, C4	CAP, 0.4pF, +/-0.05pF, 0603, ATC	2
C6	CAP, 47pF, +/-5%pF, 0603, ATC	1
C15	CAP, 100μF, 80V, ELECTROLYTIC, CAN	1
C8, C9	CAP, .1pF, +/-0.05pF, 0603, ATC	2
C11	CAP, 10.0pF, +/-5%, 0603, ATC	1
C12	CAP, 100pF, 800B, ATC	1
C13, C14	CAP, 1000pF, ATC800B	2
C7	CAP, 10μF, 16V, TANTALUM	1
R1	RES, 1/16W, 0603, 1%, 20 ohms	1
R2	RES, 1/8W, 0603, 1%, 1K ohms	1
J1, J2	CONN, SMA, PANEL MOUNT JACK, FLANGE, 4-HOLE, BLUNT POST, 20MIL	2
J3	HEADER RT>PLZ .1CEN LK 9POS	1
Q1	CG2H40035F	1

CG2H40035F-AMP Demonstration Amplifier Circuit

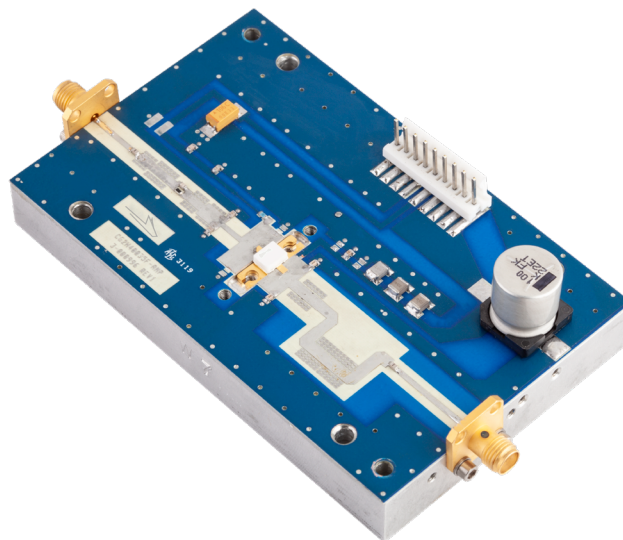



CG2H40035F-AMP1 Application Circuit Schematic

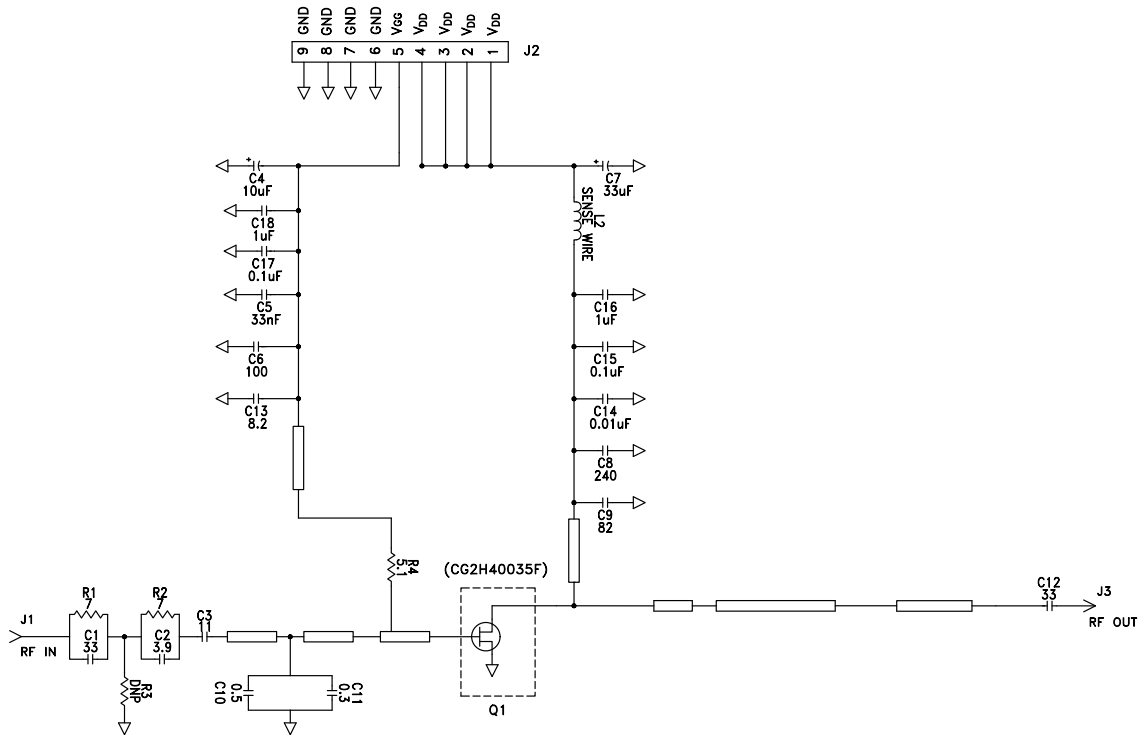

CG2H40035F-AMP1 Application Circuit Outline

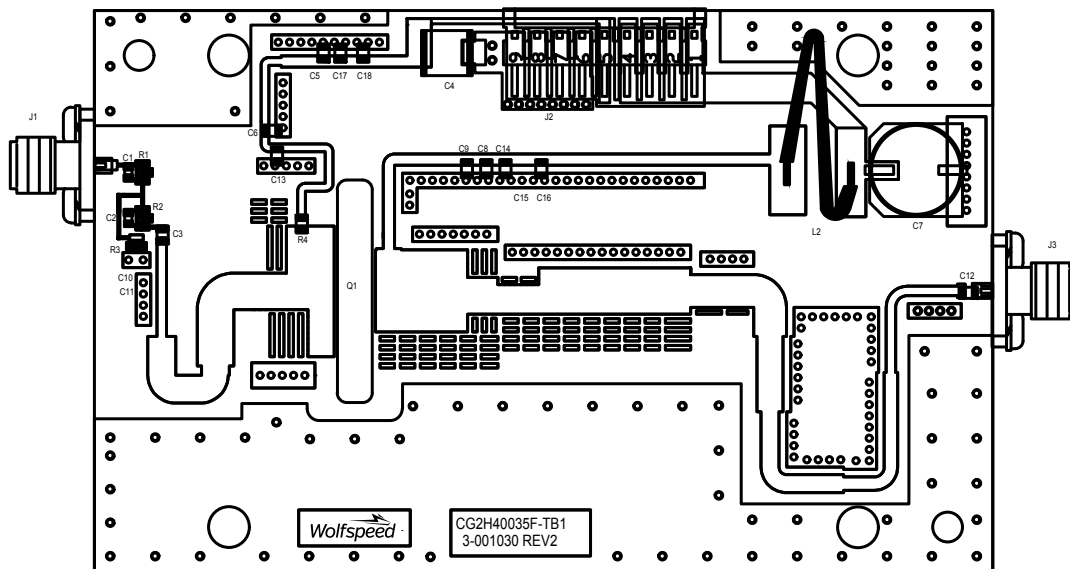



CG2H40035F-AMP1 Application Circuit Bill of Materials

Designator	Description	Qty
C1	CAP, 33 pF, 5%, 0603, ATC600S (600S330JT250XT)	1
C2	CAP, 3.9 pF, +/- 0.1pF, 0603, ATC600S	1
C3	CAP, 11 pF, +/-5%, 0603, ATC600S	1
C4	CAP, 10 μF, 100V, +/- 20%, X7S 2220	1
C5	CAP, 33000 pF, 0805, 100V, X7R	1
C6	CAP, 100 pF, +/- 5%, 0805, ATC600F	1
C7	CAP, 33 μF, 20%, G CASE	1
C8	CAP, 240 pF, +/- 5%, 0805, ATC600F	1
C9	CAP, 82 pF, +/- 5%, 250V, 0805, ATC600F (600F820J250XT)	1
C10	CAP, 0.5 pF, +/- 0.05 pF, 0603, ATC600S (600S0R5AW250XT)	1
C11	CAP, 0.3 pF, +/- 0.05pF, 0603, ATC600S (600S0R3AT250XT)	1
C12	CAP, 33 pF, +/- 5%, 0805, ATC600F	1
C13	CAP, 8.2 pF, +/- 0.1pF, 250V, 0805, ATC600F (600F8R2BT250XT)	1
C14	CAP, 0.01 μF, +/- 10%, 250V, 0805, X7R	1
C15	CAP, 0.1 μF, +/- 10%, 250V, 1206, X7R	1
C16, C18	CAP, 1 μF, 0805, 100V, X7S	2
C17	CAP, CER, 0.1 μF, 100V, 10%, X7R, 0805	1
C19	CAP, 0.3 pF, +/- 0.05pF, 0805, ATC600F (600F0R3AT250XT)	1
J1, J3	CONN, SMA, PANEL MOUNT JACK, FLANGE, 4-HOLE, BLUNT POST	2
J2	HEADER RT>PLZ .1CEN LK 9POS	1
L2	WIRE, BLACK, 20 GAUGE, APPROX 3-4 INCHES	1
Q1	TRANSISTOR, 35 WATTS, GAN HEMT	1
R1, R2	RESISTOR, 7 ohms, IMS, ALN 15 MIL THICK, 0805, CS	2
R3 (not placed)	RESISTOR, 175 ohms, IMS, ALN 15 MIL THICK, 0805, CS	1
R4	RESISTOR, 5.1 ohms, 0805, 1/8 W	1



Typical Package S-Parameters for CG2H40035F
 (Small Signal, $V_{DS} = 28\text{ V}$, $I_{DQ} = 250\text{ mA}$, angle in degrees)

Frequency	Mag S11	Ang S11	Mag S21	Ang S21	Mag S12	Ang S12	Mag S22	Ang S22
0.5	0.921	-166.78	10.837	87.47	0.013	4.98	0.679	-174.42
0.6	0.921	-169.95	9.042	84.19	0.013	3.64	0.683	-175.85
0.7	0.921	-172.39	7.749	81.28	0.012	2.72	0.687	-176.98
0.8	0.921	-174.36	6.775	78.60	0.012	2.07	0.690	-177.94
0.9	0.921	-176.02	6.013	76.09	0.012	1.60	0.693	-178.78
1.0	0.921	-177.46	5.403	73.72	0.012	1.32	0.695	-179.45
1.1	0.922	-178.73	4.901	71.37	0.012	1.07	0.698	179.74
1.2	0.922	-179.89	4.482	69.12	0.012	0.96	0.701	179.07
1.3	0.923	179.05	4.127	66.94	0.012	0.94	0.704	178.42
1.4	0.923	178.05	3.821	64.80	0.012	1.00	0.707	177.78
1.5	0.923	177.11	3.556	62.71	0.012	1.15	0.710	177.16
1.6	0.924	176.22	3.323	60.65	0.011	1.37	0.714	176.54
1.7	0.924	175.36	3.117	58.62	0.011	1.68	0.717	175.92
1.8	0.925	174.54	2.934	56.62	0.011	2.06	0.720	175.30
1.9	0.926	173.74	2.770	54.65	0.011	2.52	0.724	174.68
2.0	0.926	172.96	2.622	52.71	0.011	3.06	0.727	174.06
2.1	0.927	172.20	2.488	50.79	0.011	3.68	0.730	173.43
2.2	0.927	171.46	2.366	48.90	0.011	4.38	0.734	172.79
2.3	0.928	170.73	2.255	47.03	0.011	5.15	0.737	172.14
2.4	0.928	170.01	2.153	45.18	0.011	6.01	0.740	171.48
2.5	0.929	169.30	2.059	43.35	0.011	6.93	0.744	170.81
2.6	0.929	168.60	1.972	41.55	0.011	7.92	0.747	170.14
2.7	0.930	167.91	1.892	39.76	0.010	8.98	0.750	169.45
2.8	0.930	167.22	1.818	38.00	0.010	10.09	0.754	168.75
2.9	0.931	166.54	1.749	36.25	0.010	11.26	0.757	168.05
3.0	0.931	165.86	1.685	34.53	0.010	12.46	0.760	167.33
3.1	0.932	165.19	1.625	32.82	0.010	13.70	0.763	166.60
3.2	0.932	164.52	1.570	31.13	0.011	14.97	0.766	165.87
3.4	0.933	163.19	1.468	27.81	0.011	17.53	0.772	164.36
3.6	0.934	161.86	1.379	24.55	0.011	20.07	0.777	162.81
3.8	0.934	160.55	1.301	21.35	0.011	22.51	0.782	161.23
4.0	0.935	159.23	1.231	18.21	0.012	24.78	0.787	159.60
4.2	0.935	157.91	1.169	15.13	0.012	26.83	0.791	157.93
4.4	0.936	156.60	1.114	12.09	0.013	28.62	0.795	156.21
4.6	0.936	155.27	1.065	9.09	0.013	30.13	0.798	154.45
4.8	0.936	153.94	1.021	6.13	0.014	31.35	0.801	152.64
5.0	0.936	152.60	0.981	3.19	0.015	32.28	0.803	150.78
5.2	0.936	151.25	0.946	0.29	0.016	32.92	0.805	148.86
5.4	0.936	149.88	0.915	-2.60	0.017	33.28	0.807	146.89
5.6	0.936	148.50	0.888	-5.48	0.018	33.39	0.808	144.85
5.8	0.935	147.09	0.863	-8.35	0.019	33.24	0.809	142.73
6.0	0.935	145.66	0.842	-11.23	0.020	32.87	0.809	140.54

To download the s-parameters in s2p format, go to the [CG2H40035F](#) Product Page and click on the documentation tab.



Typical Package S-Parameters for CG2H40035F
 (Small Signal, $V_{DS} = 28\text{ V}$, $I_{DQ} = 500\text{ mA}$, angle in degrees)

Frequency	Mag S11	Ang S11	Mag S21	Ang S21	Mag S12	Ang S12	Mag S22	Ang S22
0.5	0.929	-168.26	10.923	87.49	0.010	5.60	0.715	-176.01
0.6	0.929	-171.23	9.110	84.51	0.010	5.08	0.719	-177.40
0.7	0.929	-173.52	7.809	81.86	0.010	5.00	0.722	-178.56
0.8	0.930	-175.39	6.829	79.43	0.010	5.18	0.725	-179.58
0.9	0.930	-176.97	6.065	77.13	0.010	5.52	0.727	179.51
1.0	0.930	-178.36	5.454	74.97	0.010	6.03	0.729	178.77
1.1	0.930	-179.59	4.952	72.82	0.010	6.53	0.731	177.88
1.2	0.930	179.29	4.534	70.77	0.010	7.14	0.733	177.12
1.3	0.931	178.24	4.180	68.76	0.010	7.81	0.735	176.39
1.4	0.931	177.27	3.876	66.80	0.010	8.53	0.737	175.68
1.5	0.931	176.34	3.612	64.87	0.010	9.29	0.739	174.98
1.6	0.932	175.46	3.381	62.97	0.010	10.09	0.741	174.30
1.7	0.932	174.61	3.177	61.09	0.010	10.93	0.743	173.62
1.8	0.932	173.80	2.995	59.23	0.010	11.79	0.745	172.95
1.9	0.932	173.00	2.832	57.40	0.010	12.69	0.747	172.29
2.0	0.933	172.23	2.686	55.58	0.010	13.61	0.749	171.62
2.1	0.933	171.48	2.554	53.79	0.010	14.56	0.751	170.96
2.2	0.933	170.74	2.433	52.01	0.010	15.53	0.753	170.29
2.3	0.934	170.01	2.323	50.24	0.010	16.52	0.755	169.62
2.4	0.934	169.30	2.223	48.50	0.010	17.51	0.757	168.94
2.5	0.934	168.59	2.130	46.77	0.010	18.52	0.759	168.26
2.6	0.934	167.89	2.045	45.05	0.010	19.53	0.761	167.58
2.7	0.935	167.20	1.966	43.35	0.010	20.54	0.763	166.89
2.8	0.935	166.52	1.893	41.66	0.010	21.54	0.765	166.20
2.9	0.935	165.84	1.825	39.99	0.011	22.54	0.767	165.49
3.0	0.935	165.17	1.762	38.33	0.011	23.51	0.769	164.79
3.1	0.935	164.50	1.703	36.69	0.011	24.47	0.771	164.07
3.2	0.936	163.84	1.648	35.06	0.011	25.40	0.772	163.35
3.4	0.936	162.51	1.548	31.83	0.011	27.16	0.776	161.88
3.6	0.936	161.20	1.460	28.65	0.012	28.78	0.779	160.38
3.8	0.936	159.89	1.382	25.51	0.012	30.22	0.782	158.84
4.0	0.937	158.59	1.313	22.42	0.013	31.47	0.785	157.26
4.2	0.937	157.28	1.252	19.36	0.013	32.52	0.788	155.65
4.4	0.937	155.97	1.197	16.34	0.014	33.35	0.790	153.99
4.6	0.936	154.66	1.148	13.35	0.015	33.98	0.792	152.28
4.8	0.936	153.34	1.104	10.38	0.016	34.40	0.793	150.53
5.0	0.936	152.01	1.065	7.43	0.017	34.61	0.794	148.73
5.2	0.936	150.67	1.031	4.50	0.017	34.63	0.795	146.86
5.4	0.935	149.31	1.000	1.57	0.018	34.45	0.796	144.94
5.6	0.934	147.94	0.972	-1.35	0.020	34.08	0.796	142.95
5.8	0.934	146.55	0.948	-4.27	0.021	33.54	0.795	140.88
6.0	0.933	145.13	0.927	-7.21	0.022	32.82	0.795	138.73

To download the s-parameters in s2p format, go to the [CG2H40035F](#) Product Page and click on the documentation tab.



Typical Package S-Parameters for CG2H40035F
 (Small Signal, $V_{DS} = 28\text{ V}$, $I_{DQ} = 750\text{ mA}$, angle in degrees)

Frequency	Mag S11	Ang S11	Mag S21	Ang S21	Mag S12	Ang S12	Mag S22	Ang S22
0.5	0.929	-168.69	10.902	87.14	0.010	4.35	0.723	-175.78
0.6	0.929	-171.57	9.084	84.27	0.010	4.14	0.728	-177.24
0.7	0.930	-173.80	7.781	81.72	0.010	4.39	0.732	-178.46
0.8	0.931	-175.63	6.802	79.37	0.010	4.91	0.735	-179.54
0.9	0.931	-177.19	6.040	77.17	0.010	5.60	0.737	179.49
1.0	0.932	-178.57	5.432	75.09	0.009	6.44	0.739	178.69
1.1	0.932	-179.78	4.932	73.01	0.009	7.25	0.742	177.75
1.2	0.932	179.10	4.516	71.03	0.009	8.16	0.743	176.94
1.3	0.933	178.07	4.164	69.09	0.009	9.11	0.745	176.16
1.4	0.933	177.09	3.862	67.18	0.009	10.08	0.747	175.41
1.5	0.933	176.17	3.600	65.31	0.009	11.08	0.749	174.67
1.6	0.933	175.29	3.371	63.46	0.009	12.09	0.750	173.95
1.7	0.934	174.44	3.168	61.64	0.009	13.12	0.752	173.25
1.8	0.934	173.63	2.988	59.83	0.009	14.15	0.754	172.54
1.9	0.934	172.84	2.827	58.05	0.010	15.20	0.755	171.85
2.0	0.935	172.06	2.682	56.28	0.010	16.25	0.757	171.16
2.1	0.935	171.31	2.551	54.52	0.010	17.30	0.759	170.47
2.2	0.935	170.57	2.432	52.78	0.010	18.35	0.761	169.78
2.3	0.935	169.84	2.323	51.06	0.010	19.39	0.762	169.09
2.4	0.936	169.13	2.224	49.35	0.010	20.43	0.764	168.39
2.5	0.936	168.42	2.132	47.65	0.010	21.45	0.766	167.70
2.6	0.936	167.72	2.048	45.97	0.010	22.46	0.767	167.00
2.7	0.936	167.03	1.970	44.30	0.010	23.45	0.769	166.30
2.8	0.936	166.35	1.898	42.64	0.010	24.42	0.770	165.59
2.9	0.936	165.67	1.831	41.00	0.011	25.36	0.772	164.88
3.0	0.937	165.00	1.768	39.37	0.011	26.27	0.774	164.16
3.1	0.937	164.33	1.710	37.75	0.011	27.15	0.775	163.44
3.2	0.937	163.66	1.656	36.14	0.011	27.99	0.777	162.71
3.4	0.937	162.34	1.557	32.95	0.012	29.55	0.780	161.23
3.6	0.937	161.03	1.471	29.80	0.012	30.95	0.782	159.73
3.8	0.937	159.72	1.394	26.70	0.013	32.15	0.785	158.18
4.0	0.937	158.42	1.326	23.63	0.013	33.17	0.787	156.61
4.2	0.937	157.11	1.265	20.59	0.014	33.98	0.789	155.00
4.4	0.937	155.81	1.211	17.58	0.015	34.60	0.791	153.34
4.6	0.937	154.50	1.163	14.60	0.015	35.02	0.792	151.64
4.8	0.937	153.18	1.120	11.64	0.016	35.25	0.793	149.90
5.0	0.936	151.85	1.081	8.69	0.017	35.29	0.794	148.10
5.2	0.936	150.51	1.047	5.76	0.018	35.15	0.794	146.24
5.4	0.935	149.15	1.017	2.83	0.019	34.83	0.794	144.32
5.6	0.934	147.78	0.990	-0.09	0.020	34.35	0.794	142.34
5.8	0.934	146.39	0.966	-3.02	0.021	33.69	0.793	140.28
6.0	0.933	144.97	0.945	-5.97	0.022	32.88	0.792	138.14

To download the s-parameters in s2p format, go to the [CG2H40035F](#) Product Page and click on the documentation tab.



Product Dimensions CG2H40035F (Package Type — 440166)

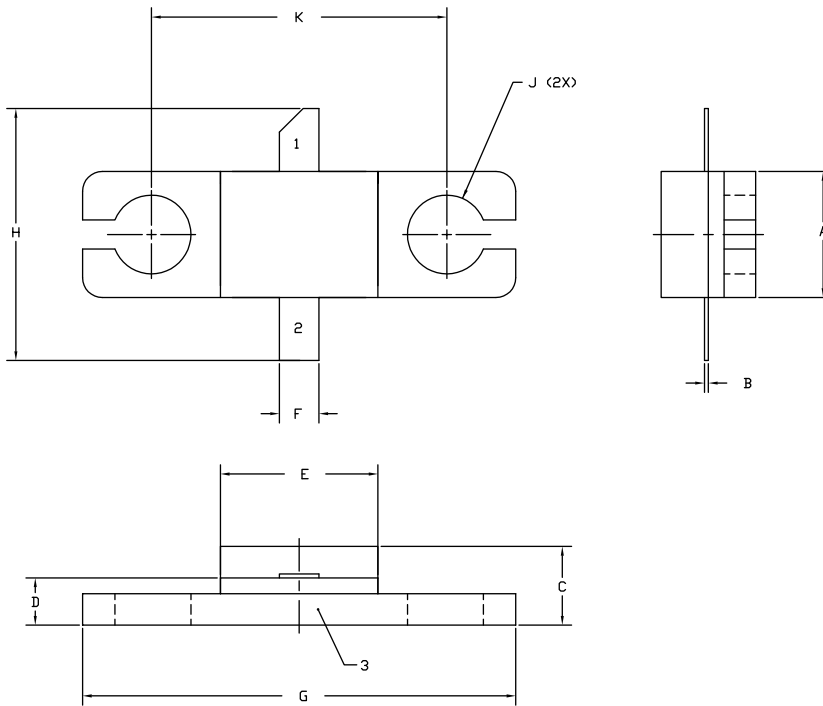

NOTES:

1. DIMENSIONING AND TOLERANCING PER ANSI Y14.5M, 1982.
2. CONTROLLING DIMENSION: INCH.
3. ADHESIVE FROM LID MAY EXTEND A MAXIMUM OF 0.020" BEYOND EDGE OF LID.
4. LID MAY BE MISALIGNED TO THE BODY OF THE PACKAGE BY A MAXIMUM OF 0.008" IN ANY DIRECTION.
5. ALL PLATED SURFACES ARE NI/AU

DIM	INCHES		MILLIMETERS	
	MIN	MAX	MIN	MAX
A	0.155	0.165	3.94	4.19
B	0.004	0.006	0.10	0.15
C	0.115	0.135	2.92	3.43
D	0.057	0.067	1.45	1.70
E	0.195	0.205	4.95	5.21
F	0.045	0.055	1.14	1.40
G	0.545	0.555	13.84	14.09
H	0.280	0.360	7.11	9.14
J	∅ .100		2.54	
K	0.375		9.53	

- PIN 1. GATE
 PIN 2. DRAIN
 PIN 3. SOURCE

Product Dimensions CG2H40035P (Package Type — 440196)

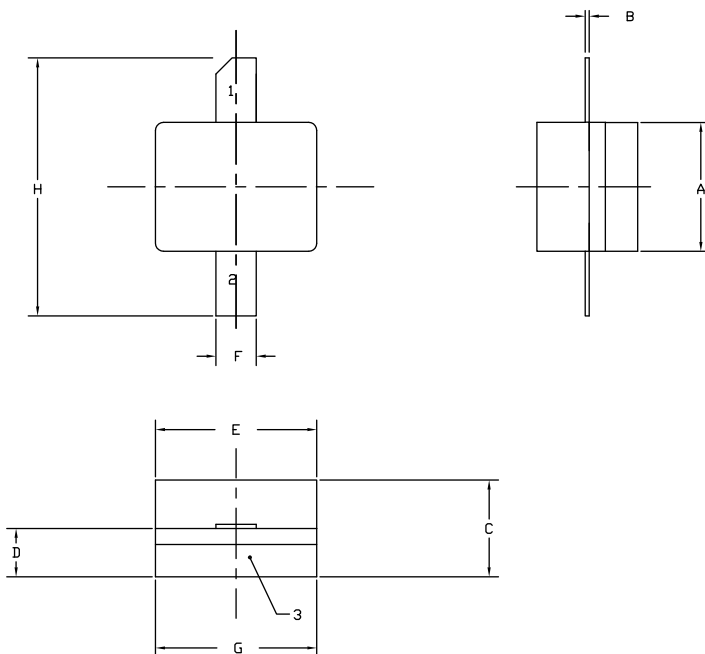

NOTES:

1. DIMENSIONING AND TOLERANCING PER ANSI Y14.5M, 1982.
2. CONTROLLING DIMENSION: INCH.
3. ADHESIVE FROM LID MAY EXTEND A MAXIMUM OF 0.020" BEYOND EDGE OF LID.
4. LID MAY BE MISALIGNED TO THE BODY OF THE PACKAGE BY A MAXIMUM OF 0.008" IN ANY DIRECTION.
5. ALL PLATED SURFACES ARE NI/AU

DIM	INCHES		MILLIMETERS	
	MIN	MAX	MIN	MAX
A	0.155	0.165	3.94	4.19
B	0.003	0.006	0.10	0.15
C	0.115	0.135	2.92	3.17
D	0.057	0.067	1.45	1.70
E	0.195	0.205	4.95	5.21
F	0.045	0.055	1.14	1.40
G	0.195	0.205	4.95	5.21
H	0.280	0.360	7.11	9.14

- PIN 1. GATE
 PIN 2. DRAIN
 PIN 3. SOURCE



Part Number System

CG2H40035F

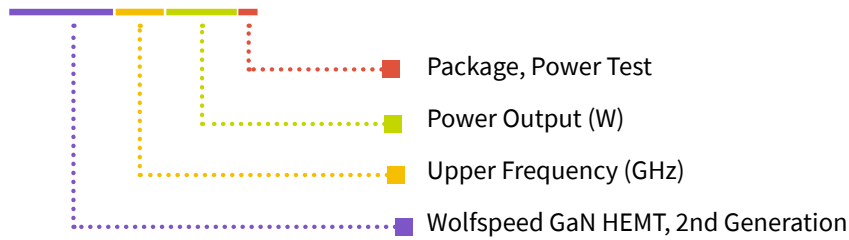

Table 1.

Parameter	Value	Units
Upper Frequency ¹	6.0	GHz
Power Output	35	W
Package	Flange or Pill	—

Note:



¹ Alpha characters used in frequency code indicate a value greater than 9.9 GHz. See Table 2 for value.

Table 2.

Character Code	Code Value
A	0
B	1
C	2
D	3
E	4
F	5
G	6
H	7
J	8
K	9
Examples:	1A = 10.0 GHz 2H = 27.0 GHz

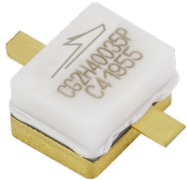

Product Ordering Information

Order Number	Description	Unit of Measure	Image
CG2H40035F	GaN HEMT	Each	
CG2H40035P	GaN HEMT	Each	
CG2H40035F-AMP	Test board with GaN HEMT installed	Each	

**For more information, please contact:**

4600 Silicon Drive
Durham, NC 27703 USA
Tel: +1.919.313.5300
www.wolfspeed.com/RF

Sales Contact
RFSales@wolfspeed.com

RF Product Marketing Contact
RFMarketing@wolfspeed.com

Notes & Disclaimer

Specifications are subject to change without notice. “Typical” parameters are the average values expected by Wolfspeed in large quantities and are provided for information purposes only. Wolfspeed products are not warranted or authorized for use as critical components in medical, life-saving, or life-sustaining applications, or other applications where a failure would reasonably be expected to cause severe personal injury or death. No responsibility is assumed by Wolfspeed for any infringement of patents or other rights of third parties which may result from use of the information contained herein. No license is granted by implication or otherwise under any patent or patent rights of Wolfspeed.

© 2019-2022 Wolfspeed, Inc. All rights reserved. Wolfspeed® and the Wolfstreak logo are registered trademarks and the Wolfspeed logo is a trademark of Wolfspeed, Inc.
PATENT: <https://www.wolfspeed.com/legal/patents>

The information in this document is subject to change without notice.