

Product Overview

Qorvo’s QPA1027 is a packaged high-power, S-band amplifier fabricated on Qorvo’s production 0.25 μm GaN on SiC High Voltage process (QGaN25HV). Covering 2.8 – 3.5 GHz, the QPA1027 provides 60 W of saturated output power and 22 dB of large-signal gain while achieving 55% power-added efficiency.

The QPA1027 is packaged in a plastic overmold QFN with a Cu paddle offering easy handling with good thermal properties. As a result, the QPA1027 has bias flexibility allowing the user to vary the voltage to achieve optimum system performance while maintaining high reliability.

The QPA1027 is matched to 50 ohms with integrated DC blocking caps on both I/O ports. With the high performance, good thermal characteristics and ease of handling and system integration, the QPA1027 is ideal for radar and satellite communication systems.

Lead-free and RoHS compliant.



Key Features

- Frequency Range: 2.8 – 3.5 GHz
- P_{SAT} ($P_{IN}=26$ dBm): 48 dBm
- PAE ($P_{IN}=26$ dBm): 55 %
- Small Signal Gain: > 31 dB
- Bias: Pulsed $V_D = 50$ V, $I_{DQ} = 300$ mA, $V_G = -2.7$ V typ.
- Package Dimensions: 6.0 x 6.0 x 0.85 mm

Performance is typical across frequency. Please reference electrical specification table and data plots for more details.

Functional Block Diagram

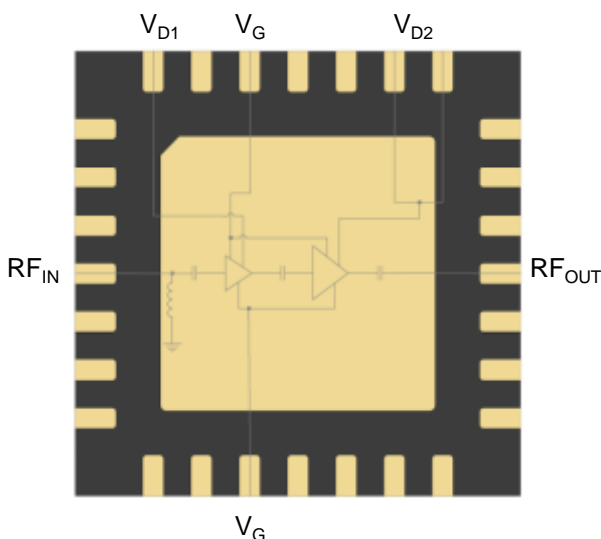

Applications

- S-Band Radar
- Satellite Communication

Ordering Information

Part No.	Description
QPA1027	S-Band 60 W GaN Power Amplifier
QPA1027S2	Samples (2 pcs. pack)
QPA1027TR7	250 pieces on a 7" reel (standard)
QPA1027EVB01	Evaluation Board for QPA1027

Absolute Maximum Ratings

Parameter	Value / Range
Drain Voltage (V_D)	+55 V
Gate Voltage Range (V_G)	-6 to 0 V
Drain Current, average (I_{D1} , I_{D2})	0.192 A, 2.3 A
Gate Current (I_G)	See chart
Power Dissipation (P_{DISS}), Pulse, $PW = 100 \mu s$, $DC = 10\%$, $85^\circ C$	80 W
Input Power (P_{IN}), Pulse, 50Ω , $V_D = 50 V$, $I_{DQ} = 300 mA$, $PW = 100 \mu s$, $DC = 10\%$, $85^\circ C$	32 dBm
Input Power (P_{IN}), Pulse, 3:1 VSWR, $V_D = 50 V$, $I_{DQ} = 300 mA$, $PW = 100 \mu s$, $DC = 10\%$, $85^\circ C$	29 dBm
Channel Temperature (T_{CH})	275 °C
Mounting Temperature (30 seconds)	260 °C
Storage Temperature	-55 to 150 °C

Operation of this device outside the parameter ranges given above may cause permanent damage. These are stress ratings only, and functional operation of the device at these conditions is not implied.

Recommended Operating Conditions

Parameter	Min	Typ	Max	Units
Pulse (not recommended CW)				
Drain Voltage (V_D), Pulsed		50	50	V
Drain Current, Quiescent (I_{DQ})		300		mA
Drain Current, RF (I_{D_Drive})	See charts page 3 - 7			mA
Gate Voltage Typ. Range (V_G)	-2 to -3.4			V
Gate Current, RF (I_{G_Drive})	See charts page 5 - 7			mA
Pulse Width/Duty Cycle		100/10%	2000/20%	us/%
Operating Temp. Range T_{BASE} (T_{BASE} is backside of QPA1027)	-40	+25	+85	°C

Electrical specifications are measured at specified test conditions. Specifications are not guaranteed over all recommended operating conditions.

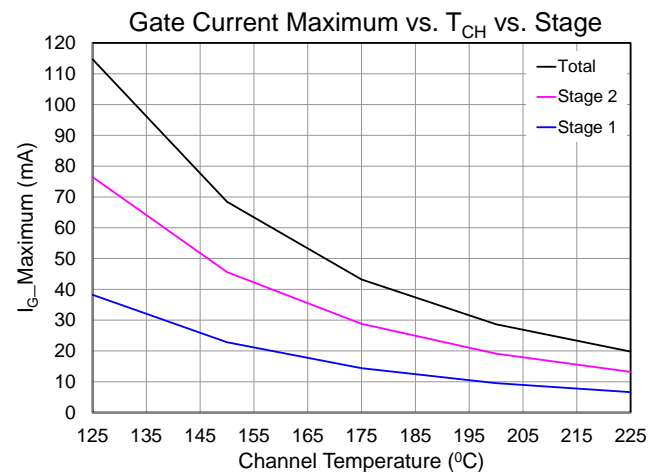

Electrical Specifications

Parameter	Conditions ^{(1) (2)}	Min	Typ	Max	Units
Operational Frequency Range		2.8		3.5	GHz
Output Power at Saturation, P_{SAT}	$P_{IN} = +26 dBm$		48		dBm
Power Added Efficiency, PAE	$P_{IN} = +26 dBm$		55		%
Small Signal Gain, S_{21}			31		dB
Input Return Loss, IRL			15		dB
Output Return Loss, ORL			7		dB
P_{SAT} Temperature Coefficient	$T_{DIFF} = -40^\circ C$ to $+85^\circ C$; $P_{IN} = +26 dBm$		-0.002		dBm/°C
S_{21} Temperature Coefficient	$T_{DIFF} = -40^\circ C$ to $+85^\circ C$		-0.04		dB/°C

Notes:

- Test conditions unless otherwise noted: Pulsed $V_D = 50 V$, $I_{DQ} = 300 mA$, $V_G = -2.7V$ +/- typical, $PW = 100 \mu s$, $DC = 10\%$, $T_{BASE} = +25^\circ C$, $Z_0 = 50 \Omega$
- T_{BASE} is back side of QPA1027

Performance Plots – Large Signal

Test conditions unless otherwise noted: Pulsed $V_D = 50\text{ V}$, $I_{DQ} = 300\text{ mA}$, $PW = 100\text{ }\mu\text{s}$, $DC = 10\%$, CW $RF_{IN} = 26\text{ dBm}$, $T_{BASE} = +25\text{ }^\circ\text{C}$ (T_{BASE} is backside of QPA1027)

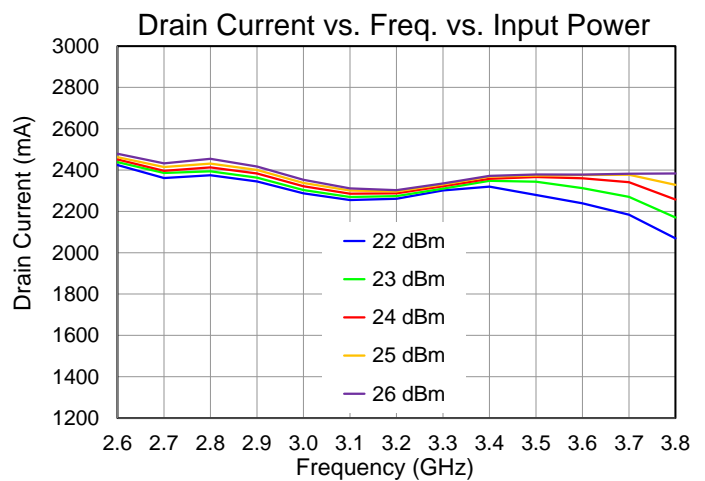
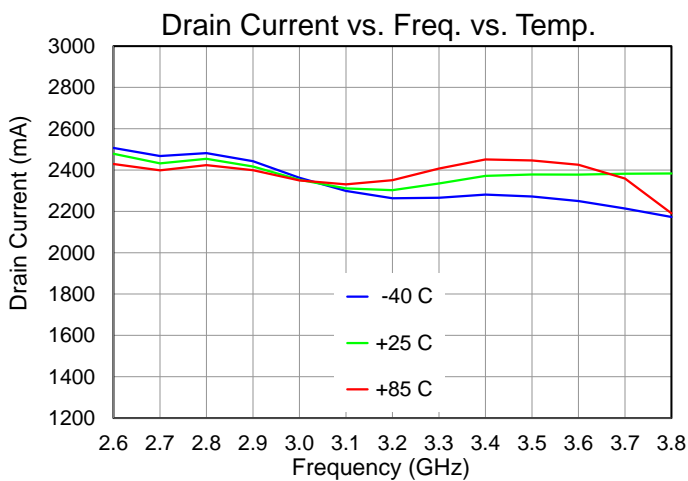
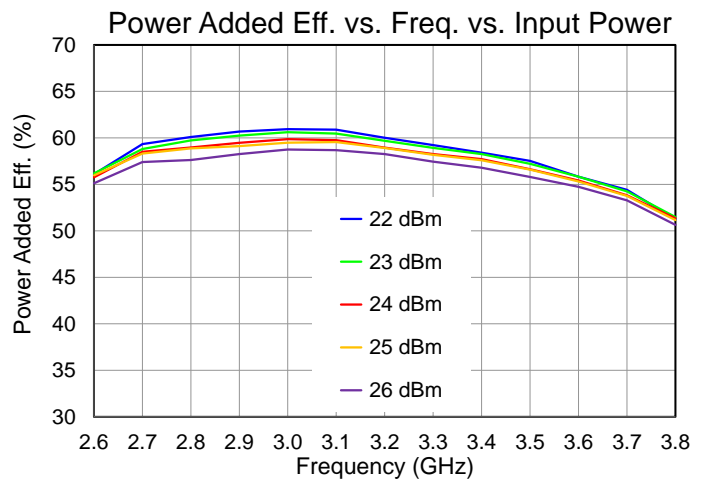
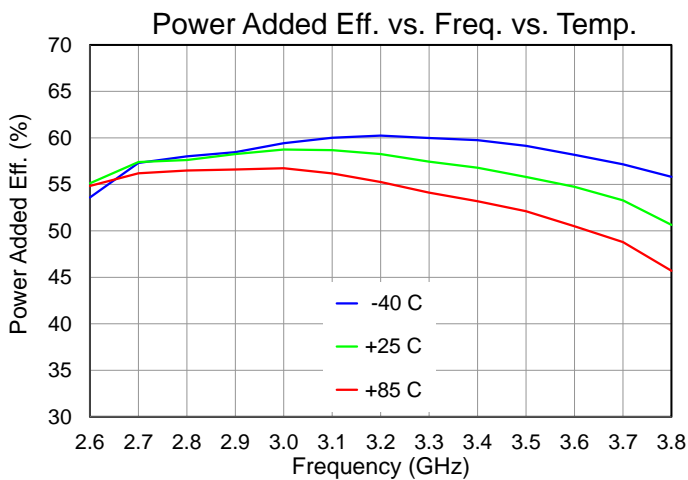
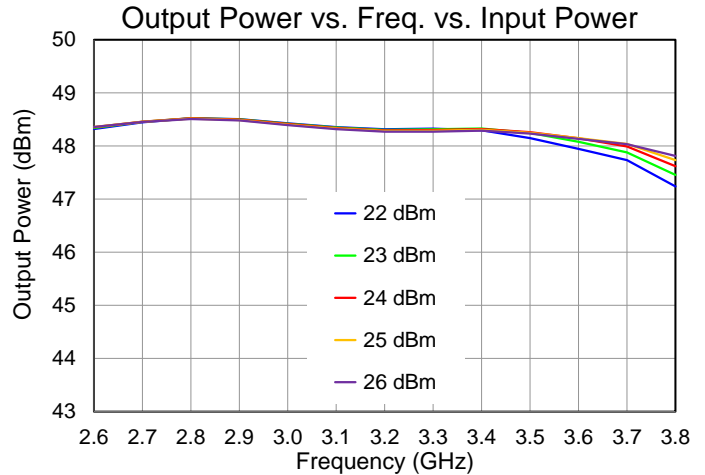
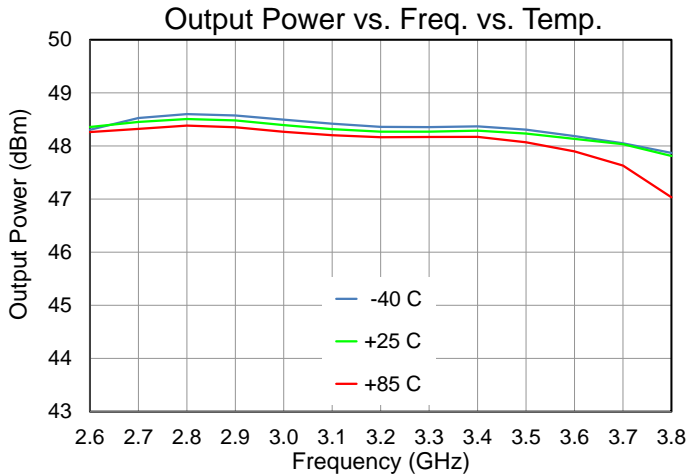

Performance Plots – Large Signal

Test conditions unless otherwise noted: Pulsed $V_D = 50\text{ V}$, $I_{DQ} = 300\text{ mA}$, $PW = 100\text{ }\mu\text{s}$, $DC = 10\%$, $CW\text{ }RF_{IN} = 26\text{ dBm}$, $T_{BASE} = +25\text{ }^\circ\text{C}$ (T_{BASE} is backside of QPA1027)

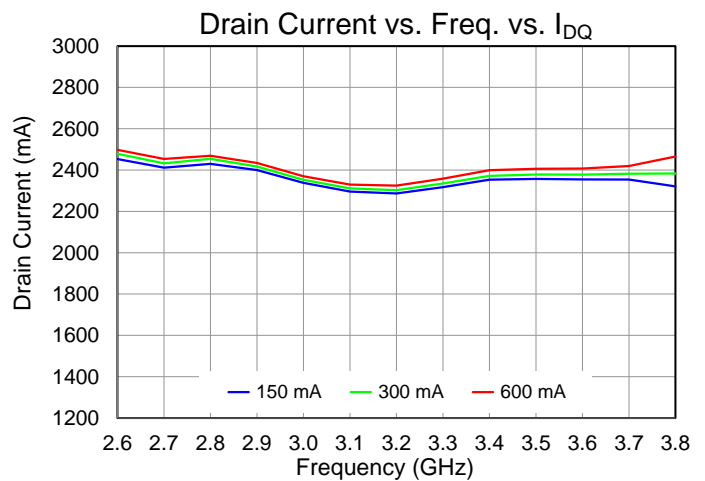
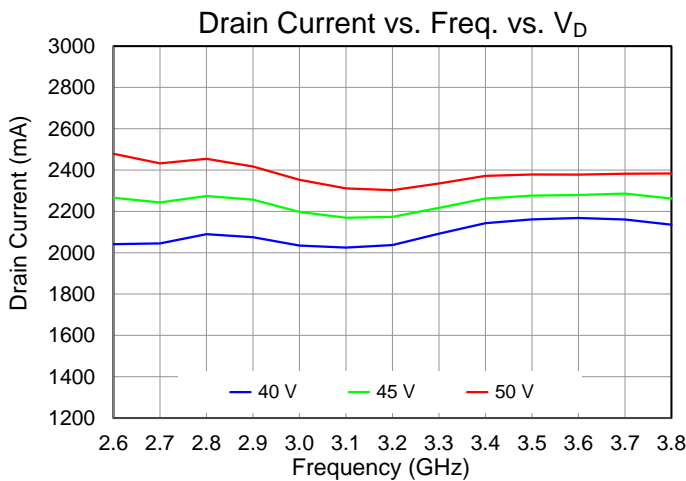
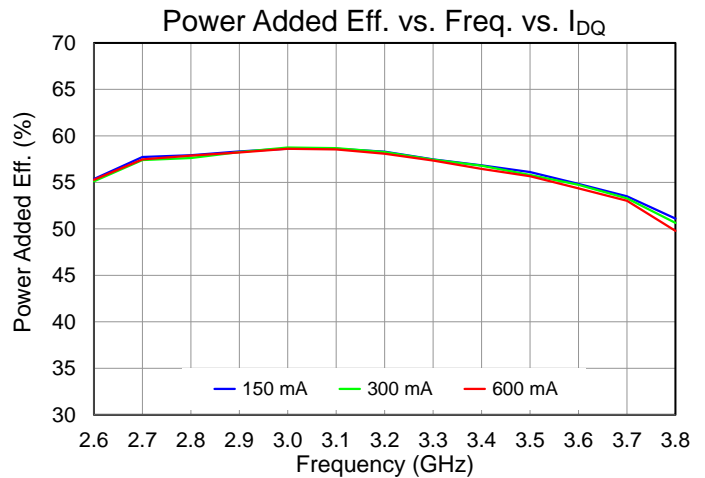
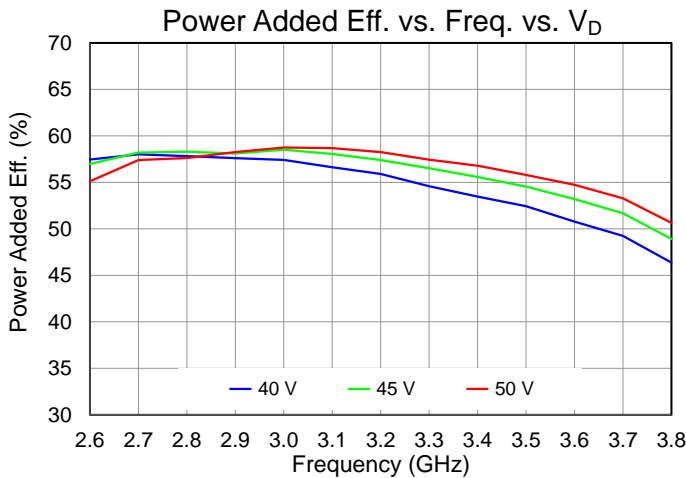
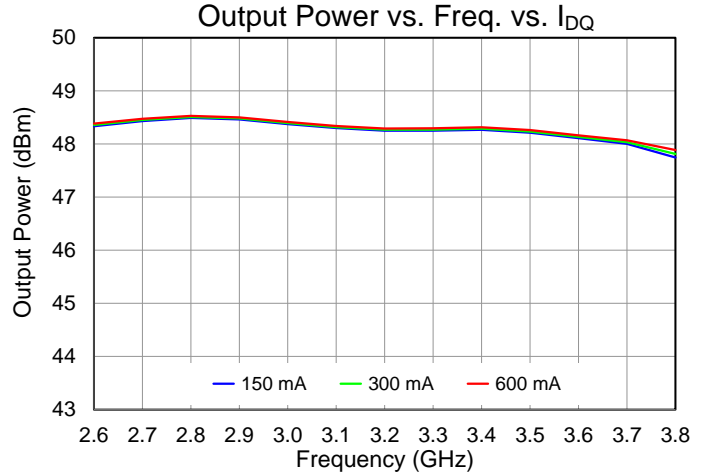
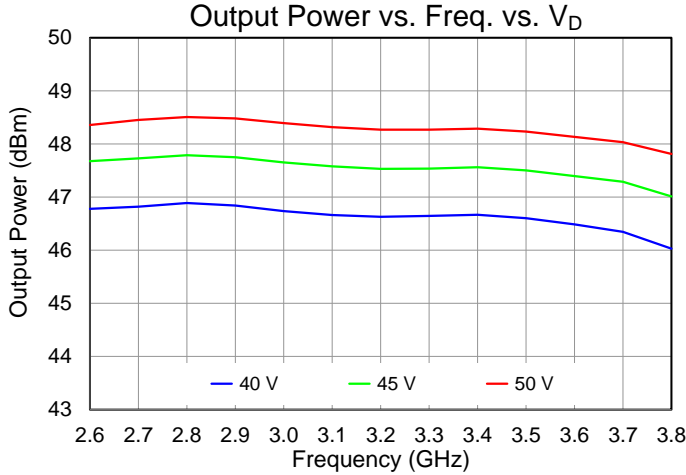

Performance Plots – Large Signal

Test conditions unless otherwise noted: Pulsed $V_D = 50\text{ V}$, $I_{DQ} = 300\text{ mA}$, $PW = 100\text{ }\mu\text{s}$, $DC = 10\%$, $CW\text{ }RF_{IN} = 26\text{ dBm}$, $T_{BASE} = +25\text{ }^\circ\text{C}$ (T_{BASE} is backside of QPA1027)

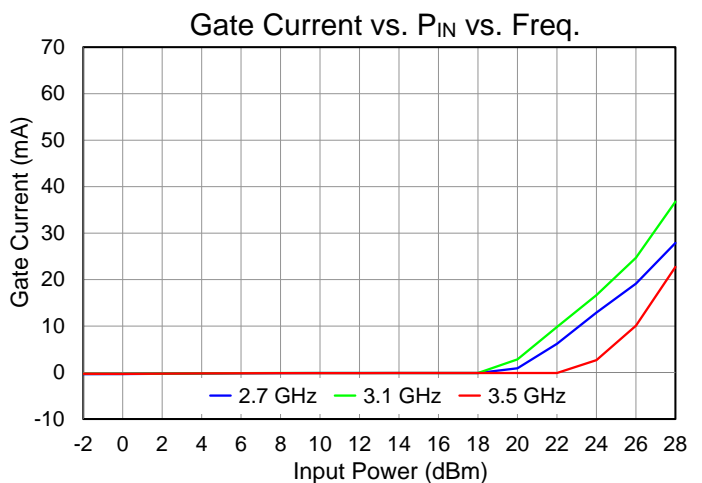
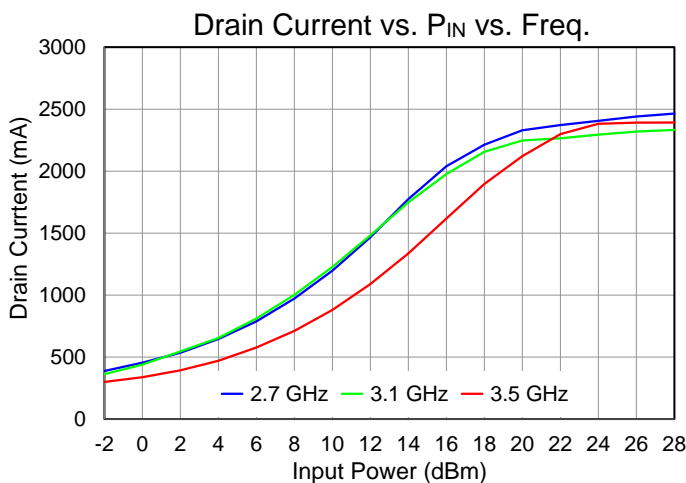
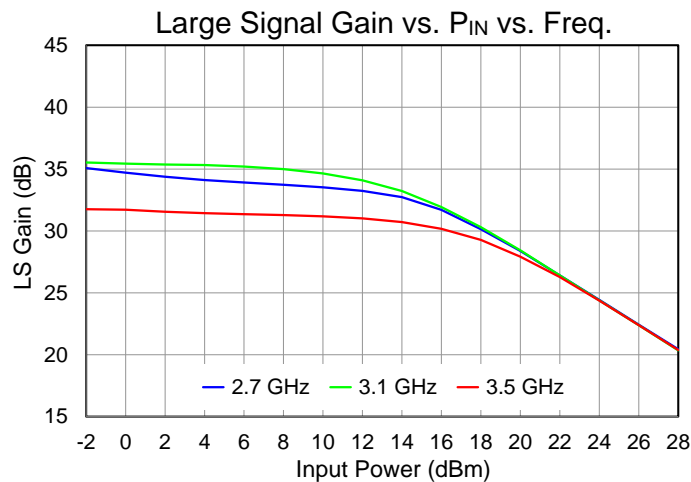
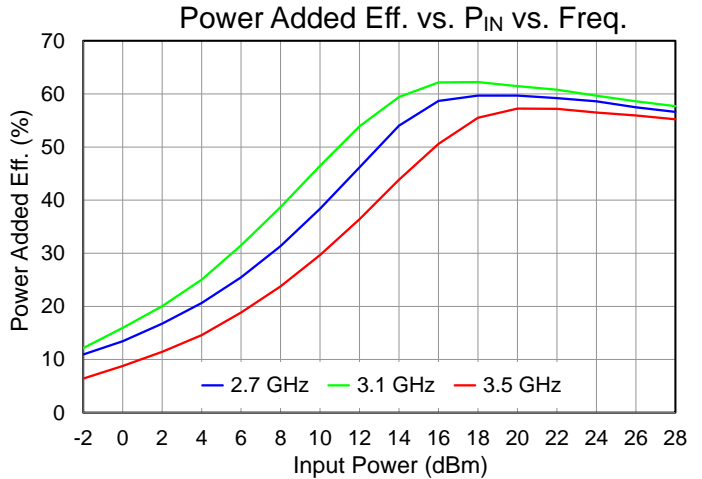
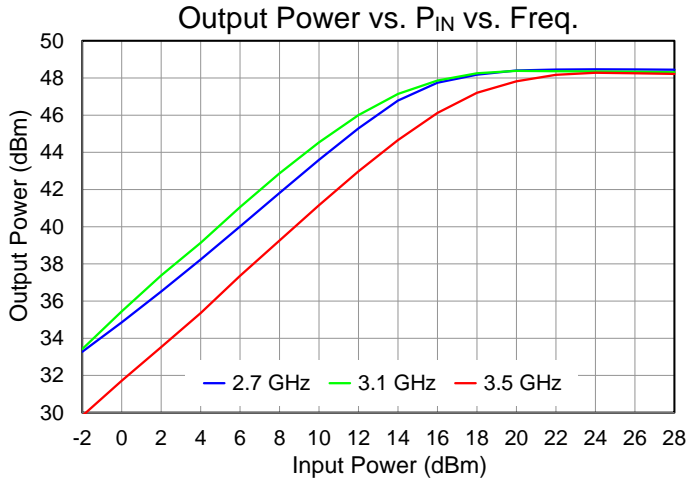

Performance Plots – Large Signal

Test conditions unless otherwise noted: Pulsed $V_D = 50\text{ V}$, $I_{DQ} = 300\text{ mA}$, $PW = 100\text{ }\mu\text{s}$, $DC = 10\%$, $CW\text{ }RF_{IN} = 26\text{ dBm}$, Frequency = 3.1 GHz, $T_{BASE} = +25\text{ }^\circ\text{C}$ (T_{BASE} is backside of QPA1027)

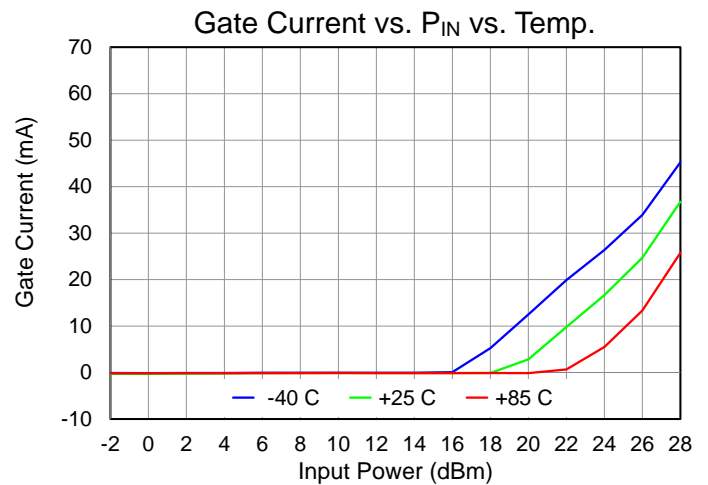
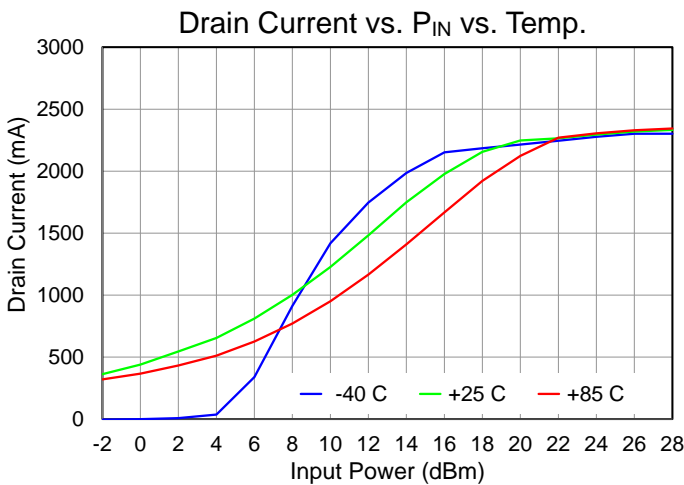
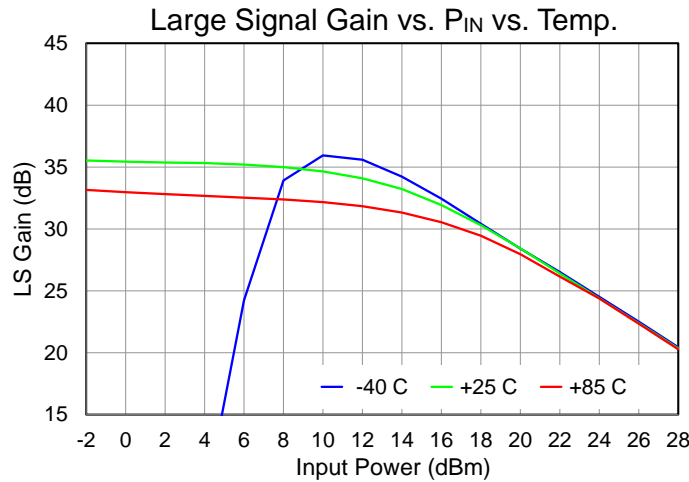
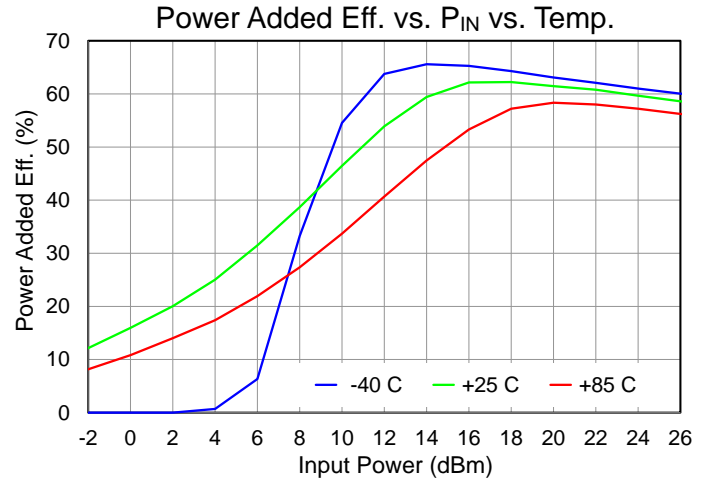
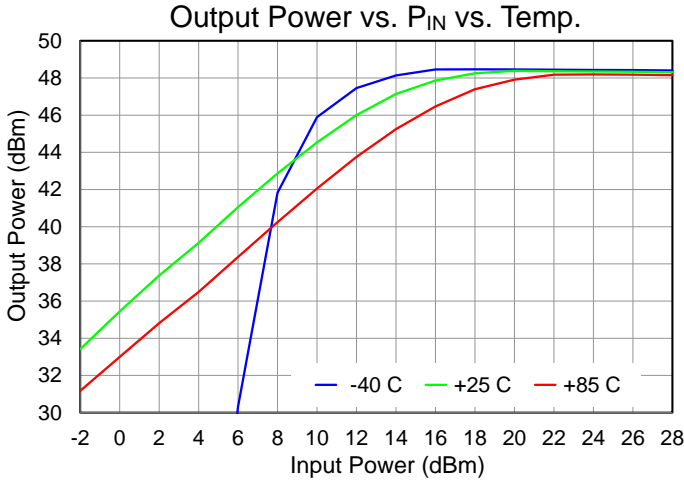

Performance Plots – Large Signal

Test conditions unless otherwise noted: Pulsed $V_D = 50\text{ V}$, $I_{DQ} = 300\text{ mA}$, $PW = 100\text{ }\mu\text{s}$, $DC = 10\%$, $CW\text{ }RF_{IN} = 26\text{ dBm}$, Frequency = 3.1 GHz, $T_{BASE} = +25\text{ }^\circ\text{C}$ (T_{BASE} is backside of QPA1027)

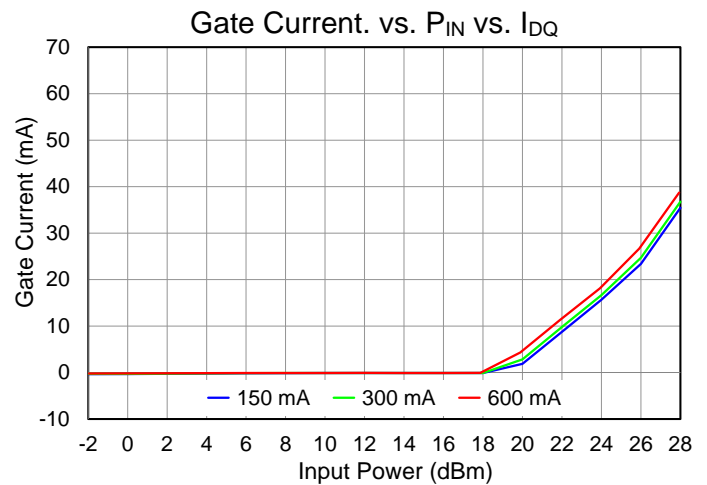
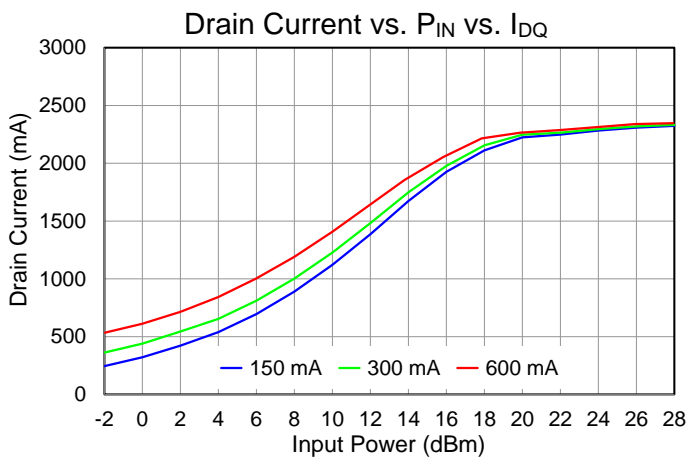
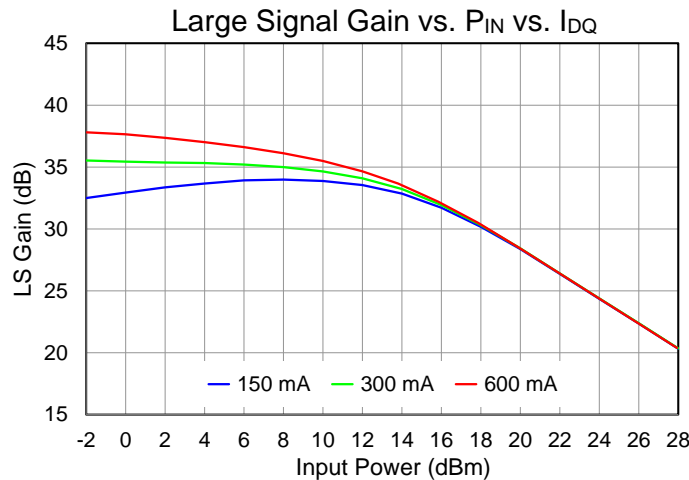
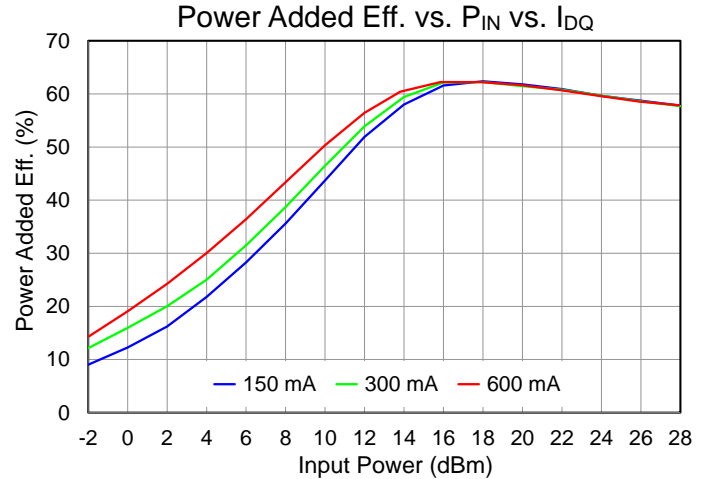
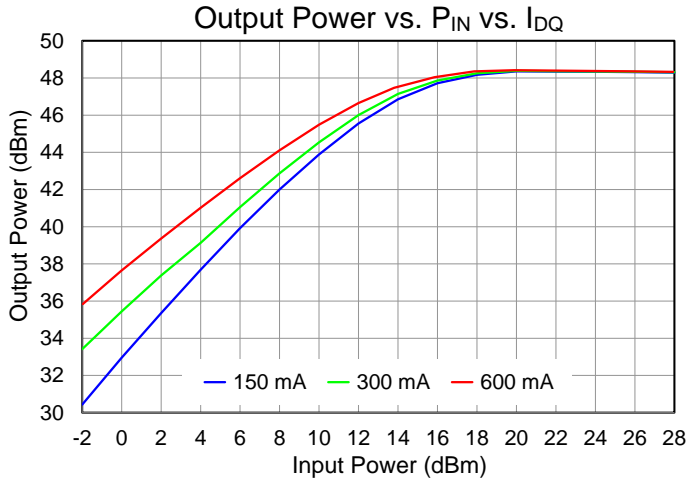

Performance Plots – Large Signal

Test conditions unless otherwise noted: Pulsed $V_D = 50\text{ V}$, $I_{DQ} = 300\text{ mA}$, $PW = 700\text{ }\mu\text{s}$, $DC = 20\%$, CW $RF_{IN} = 26\text{ dBm}$, $T_{BASE} = +25\text{ }^\circ\text{C}$ (T_{BASE} is backside of QPA1027)

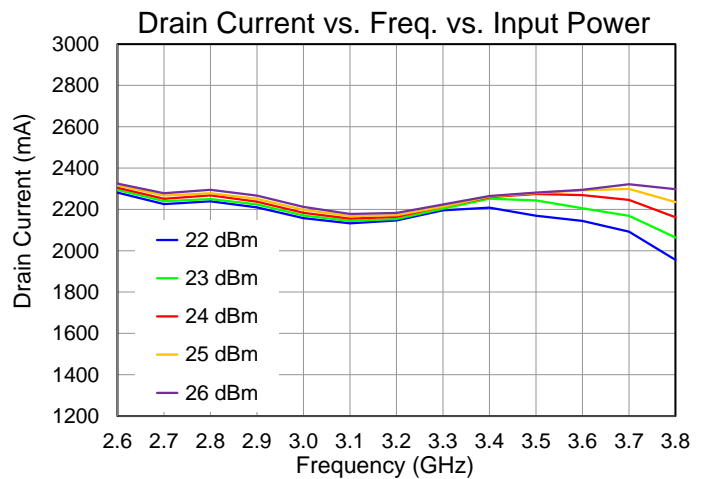
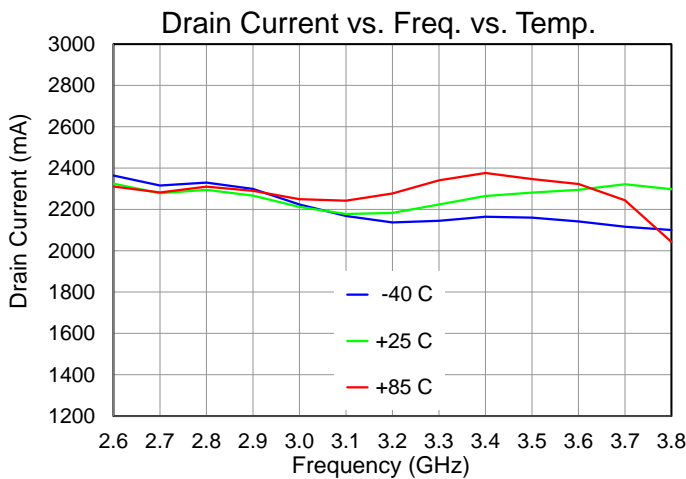
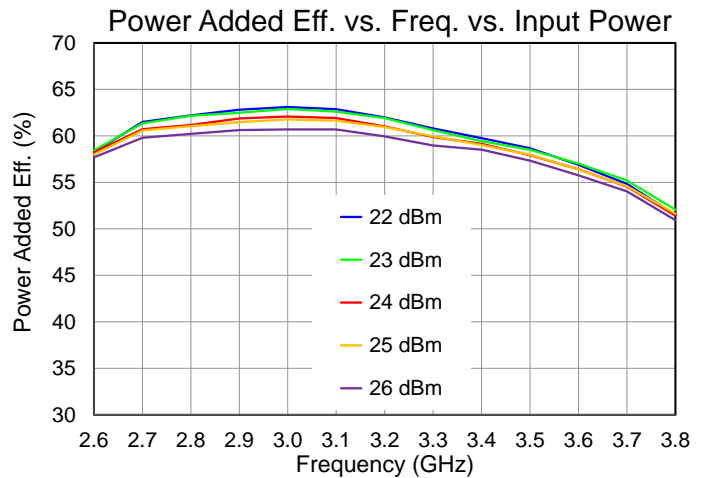
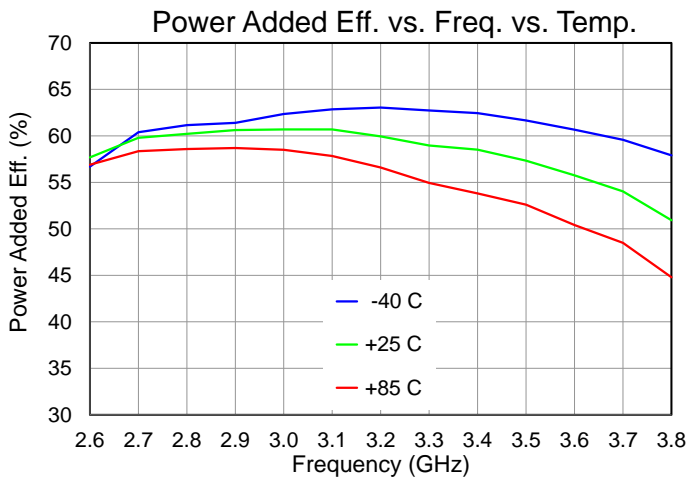
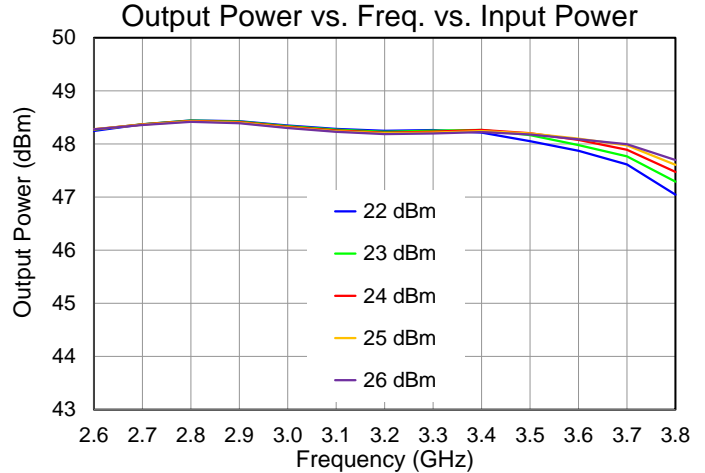
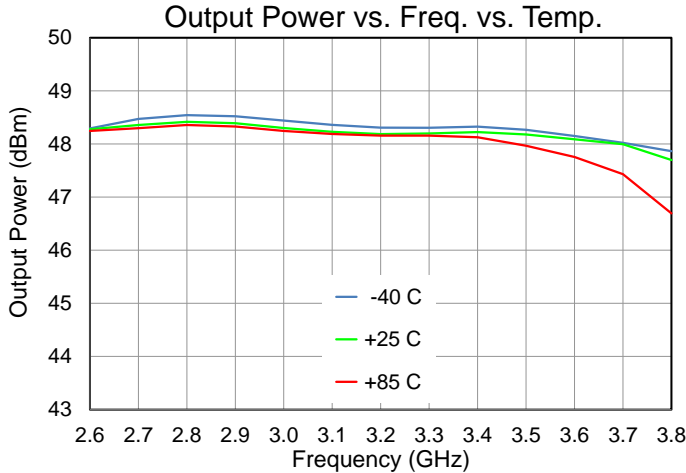

Performance Plots – Large Signal

Test conditions unless otherwise noted: Pulsed $V_D = 50\text{ V}$, $I_{DQ} = 300\text{ mA}$, $PW = 700\text{ }\mu\text{s}$, $DC = 20\%$, CW $RF_{IN} = 26\text{ dBm}$, $T_{BASE} = +25\text{ }^\circ\text{C}$ (T_{BASE} is backside of QPA1027)

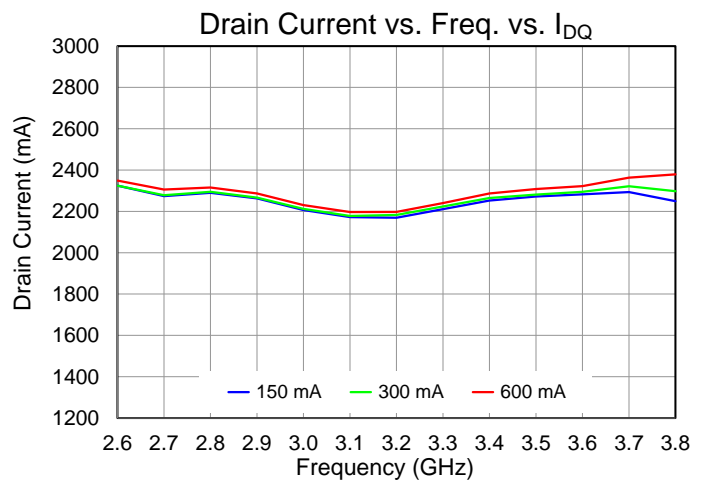
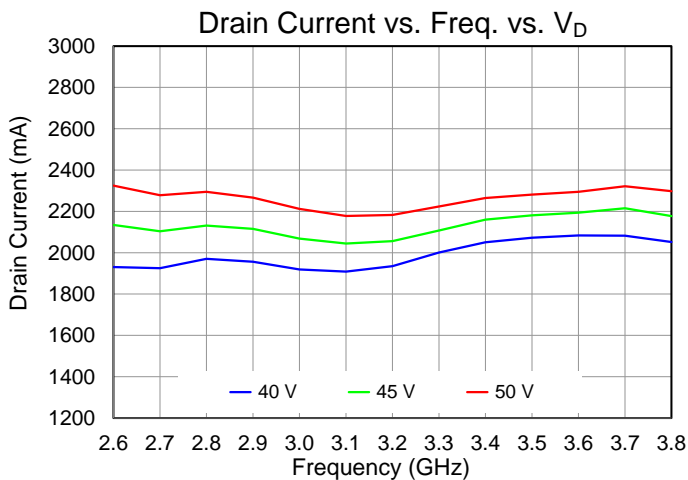
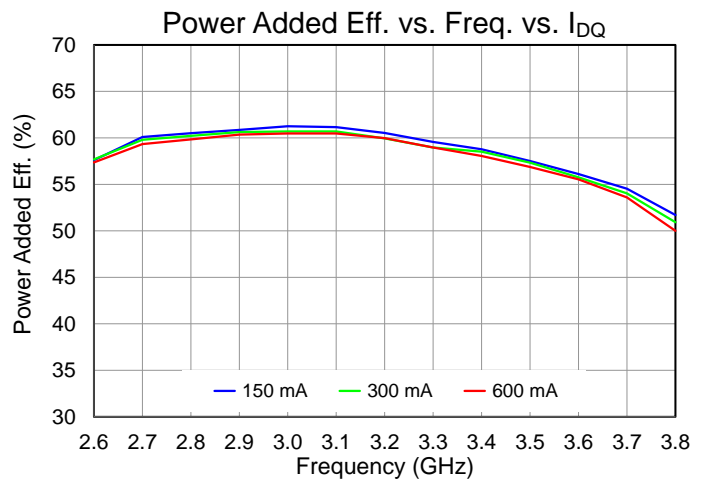
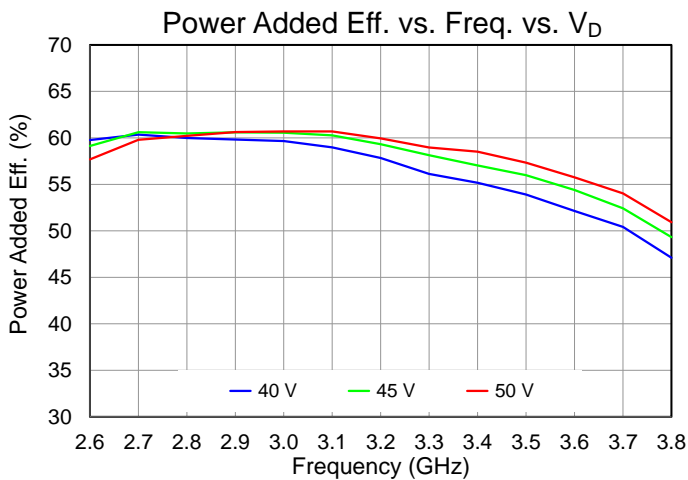
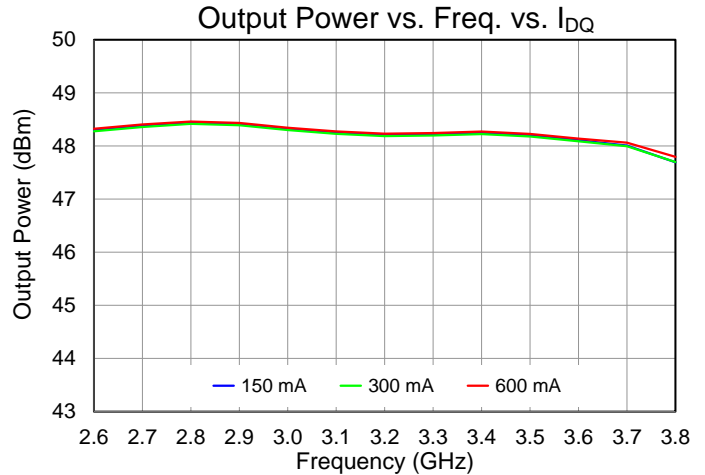
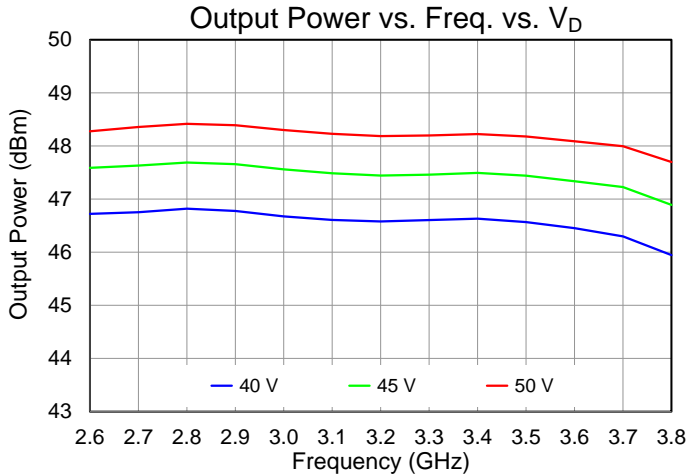

Performance Plots – Large Signal

Test conditions unless otherwise noted: Pulsed $V_D = 50\text{ V}$, $I_{DQ} = 300\text{ mA}$, $PW = 700\text{ us}$, $DC = 20\%$, $CW\text{ RF}_{IN} = 26\text{ dBm}$, $T_{BASE} = +25\text{ }^\circ\text{C}$ (T_{BASE} is backside of QPA1027)

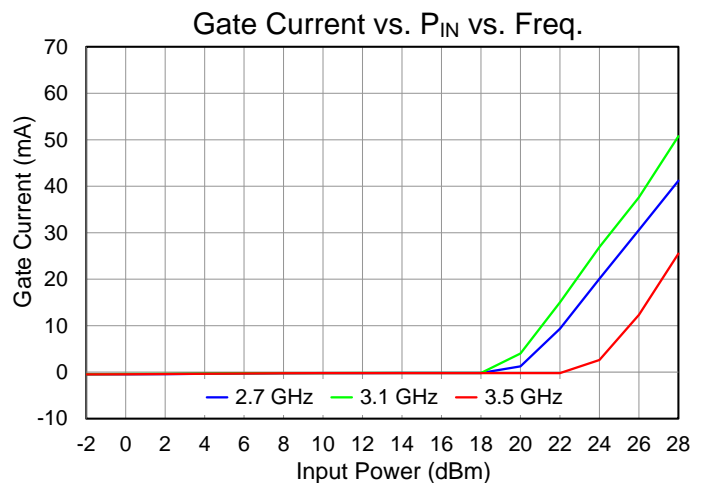
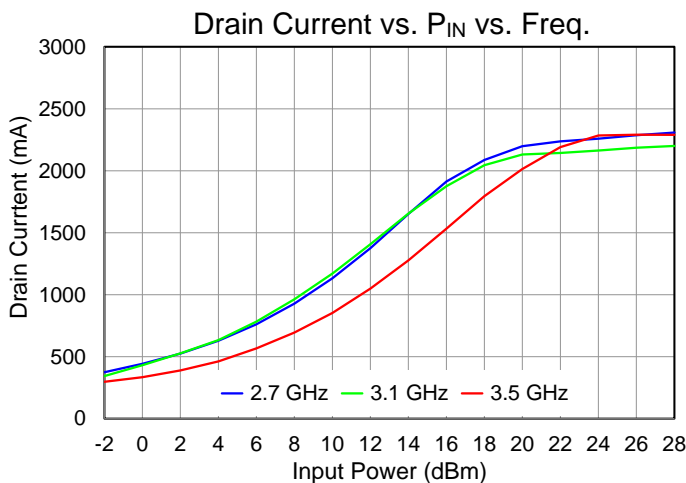
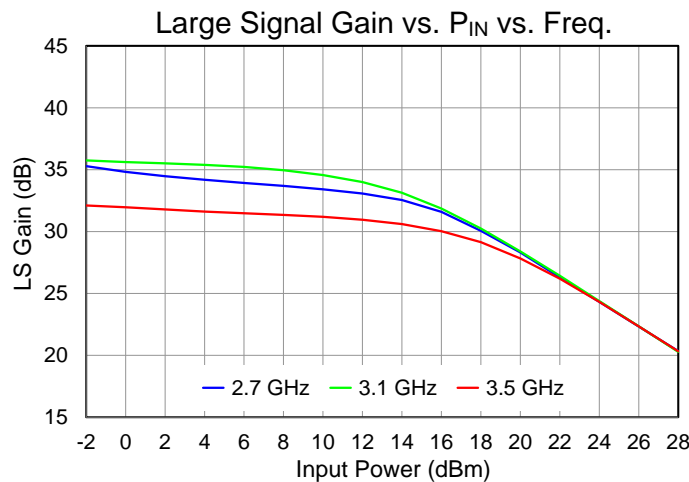
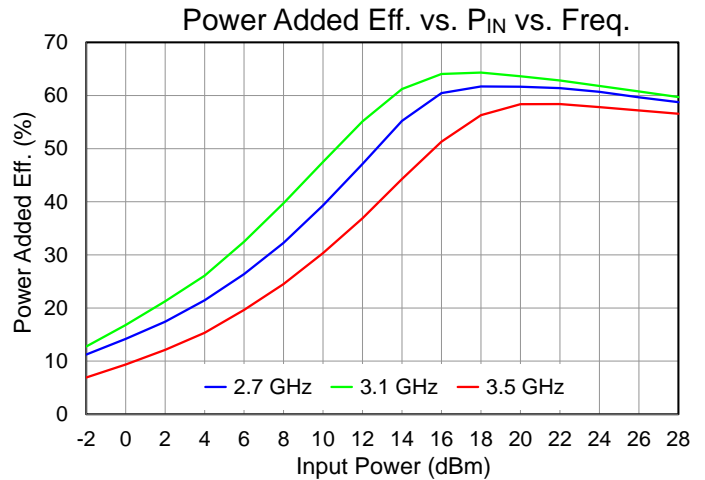
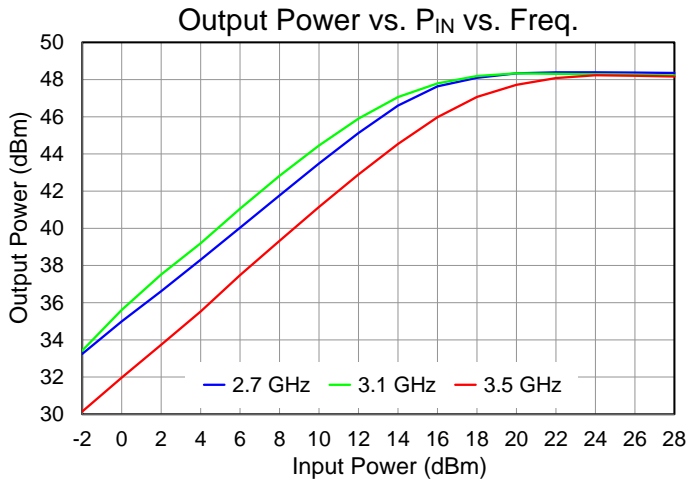

Performance Plots – Large Signal

Test conditions unless otherwise noted: Pulsed $V_D = 50\text{ V}$, $I_{DQ} = 300\text{ mA}$, $PW = 700\text{ }\mu\text{s}$, $DC = 20\%$, $CW\text{ }RF_{IN} = 26\text{ dBm}$, Frequency = 3.1 GHz, $T_{BASE} = +25\text{ }^\circ\text{C}$ (T_{BASE} is backside of QPA1027)

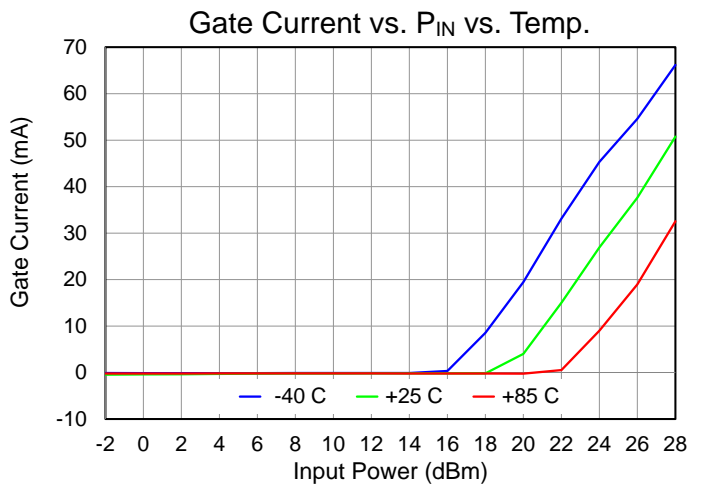
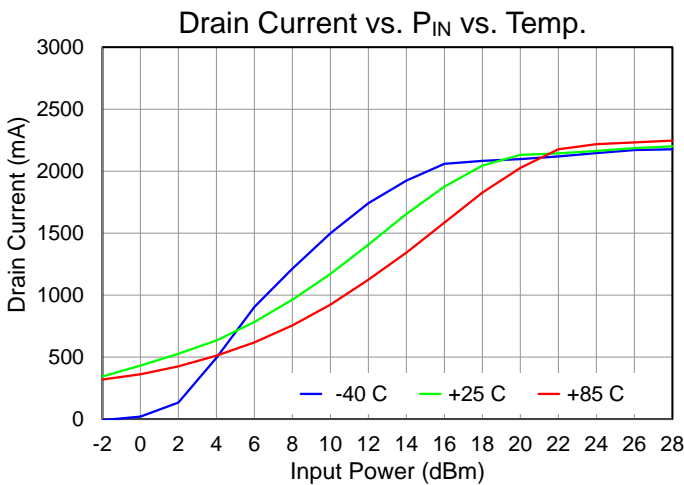
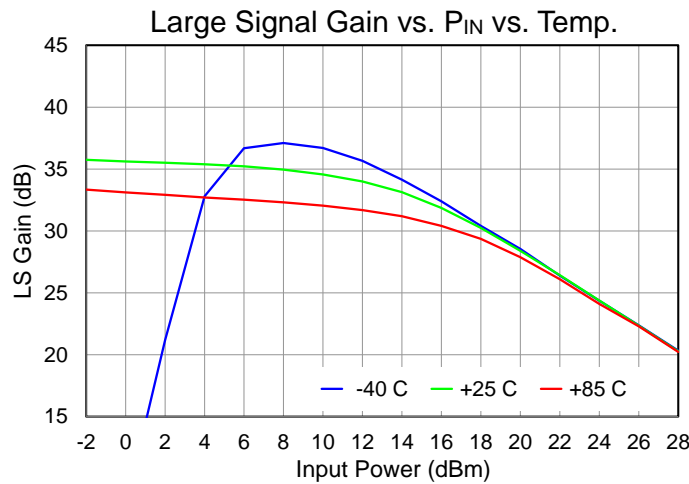
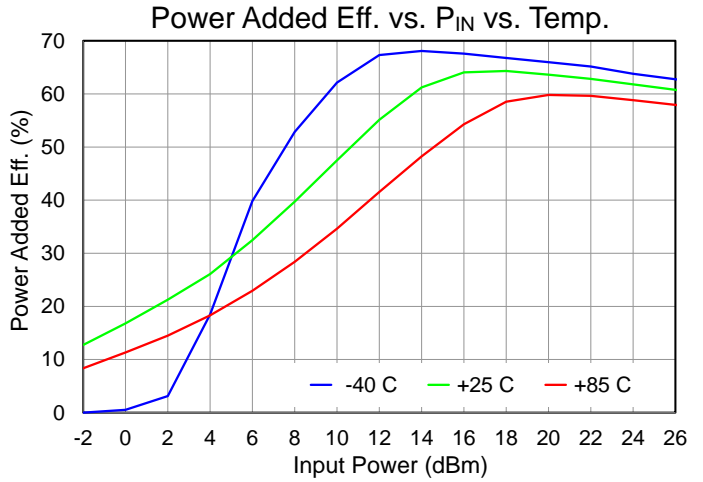
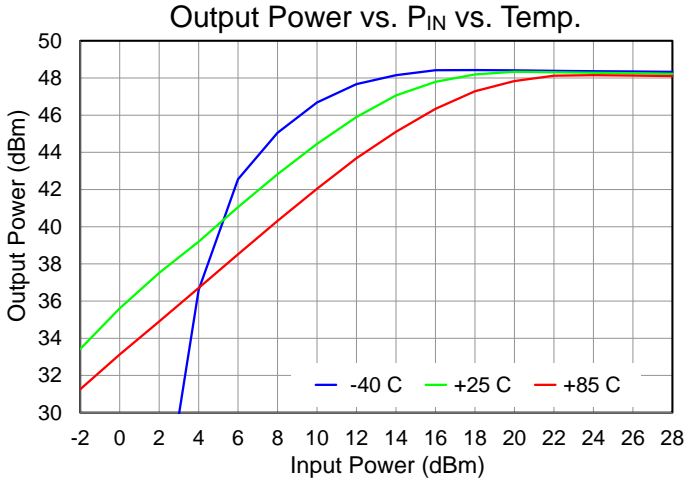

Performance Plots – Large Signal

Test conditions unless otherwise noted: Pulsed $V_D = 50\text{ V}$, $I_{DQ} = 300\text{ mA}$, $PW = 700\text{ }\mu\text{s}$, $DC = 20\%$, CW $RF_{IN} = 26\text{ dBm}$, Frequency = 3.1 GHz, $T_{BASE} = +25\text{ }^\circ\text{C}$ (T_{BASE} is backside of QPA1027)

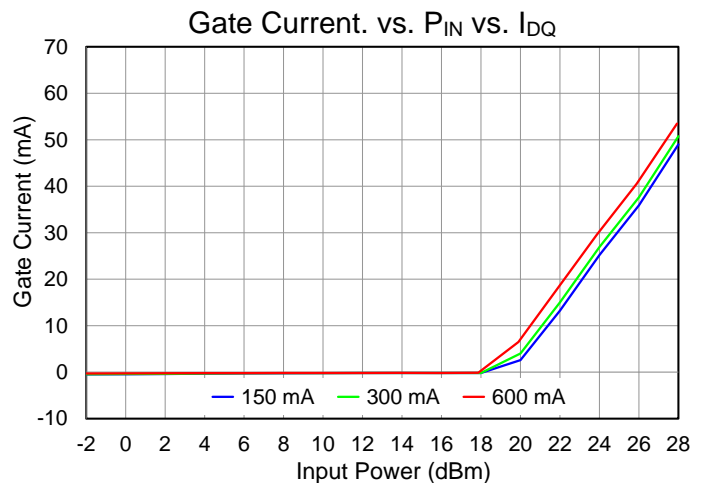
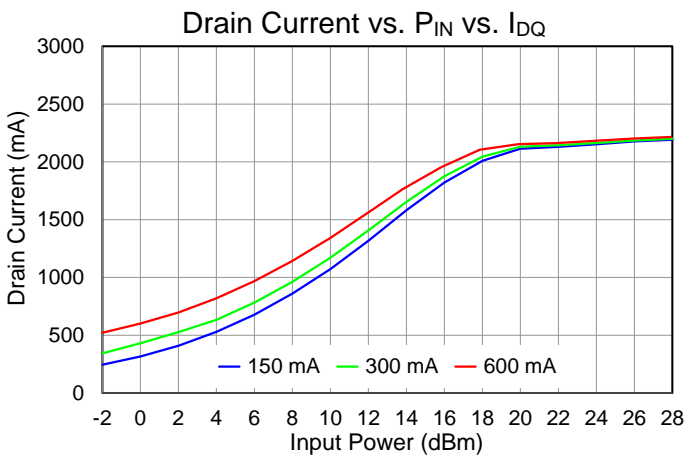
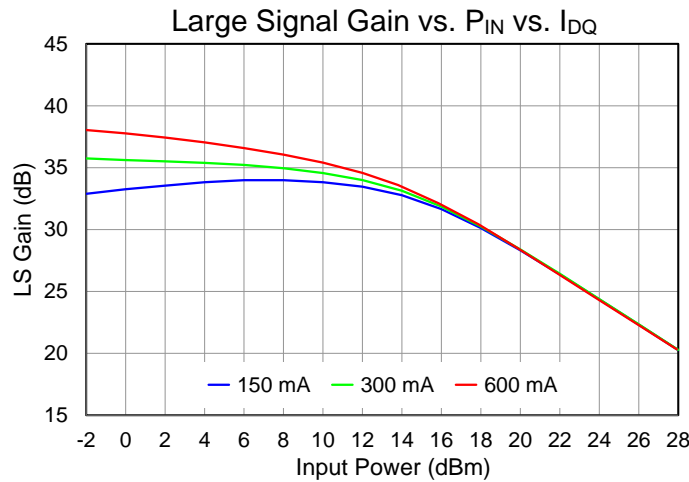
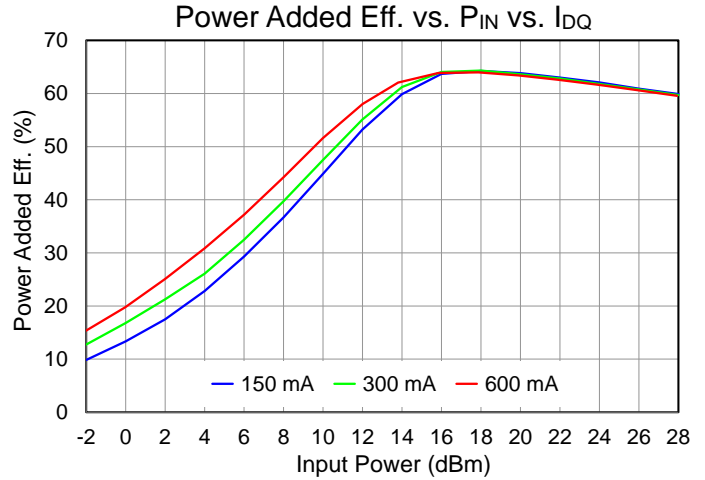
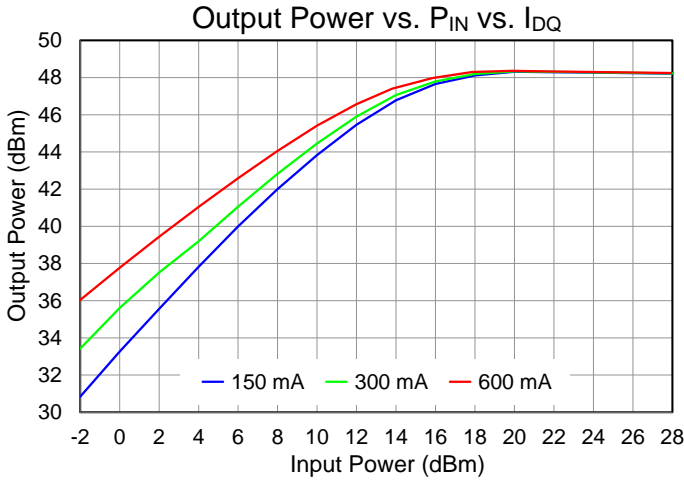

Performance Plots – Large Signal

Test conditions unless otherwise noted: Pulsed $V_D = 50\text{ V}$, $I_{DQ} = 300\text{ mA}$, CW $RF_{IN} = 26\text{ dBm}$, $T_{BASE} = +25\text{ }^\circ\text{C}$ (T_{BASE} is backside of QPA1027)

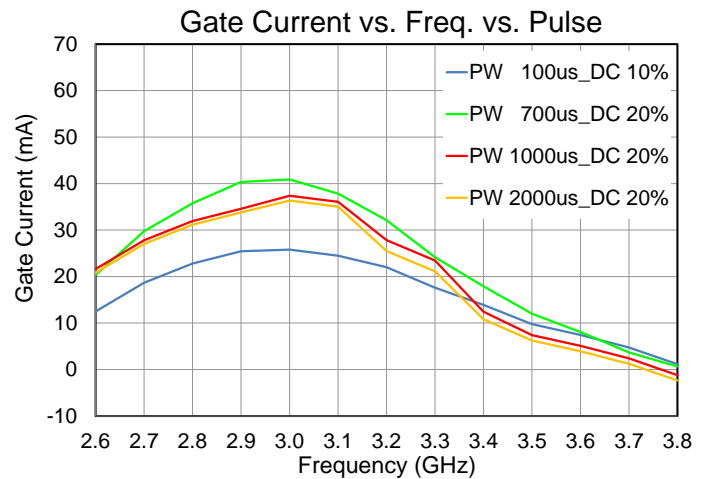
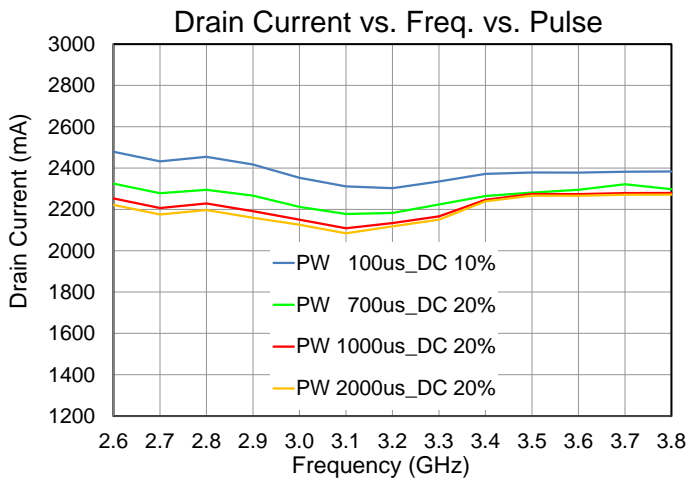
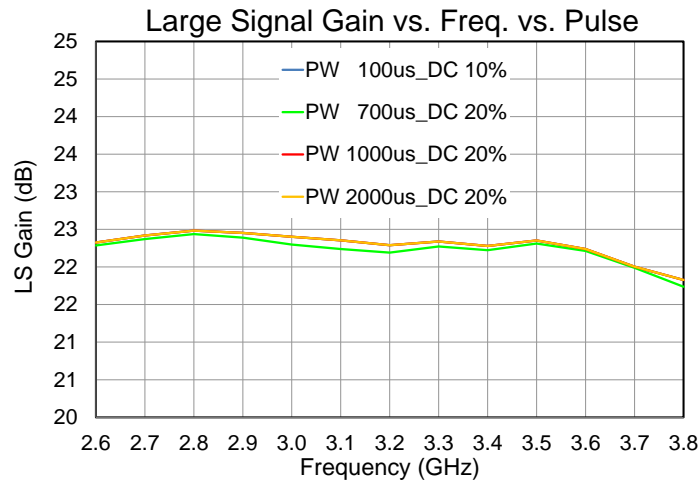
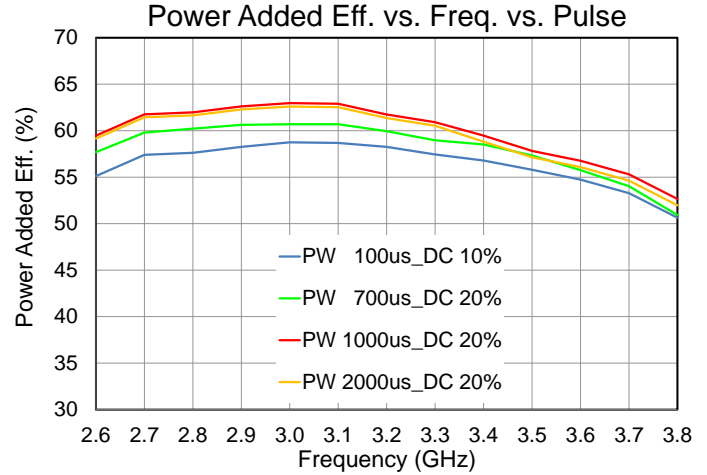
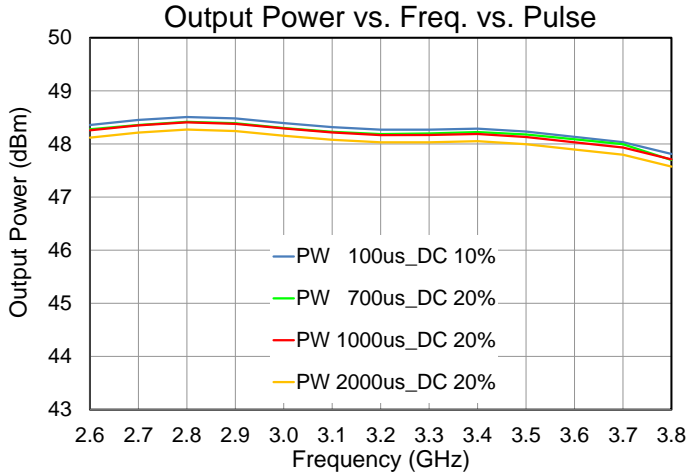

Performance Plots – Harmonics

Test conditions unless otherwise noted: Pulsed $V_D = 50$ V, $I_{DQ} = 300$ mA, $PW = 100$ μ s, $DC = 10\%$, CW $RF_{IN} = 26$ dBm, $T_{BASE} = +25$ °C (T_{BASE} is backside of QPA1027)

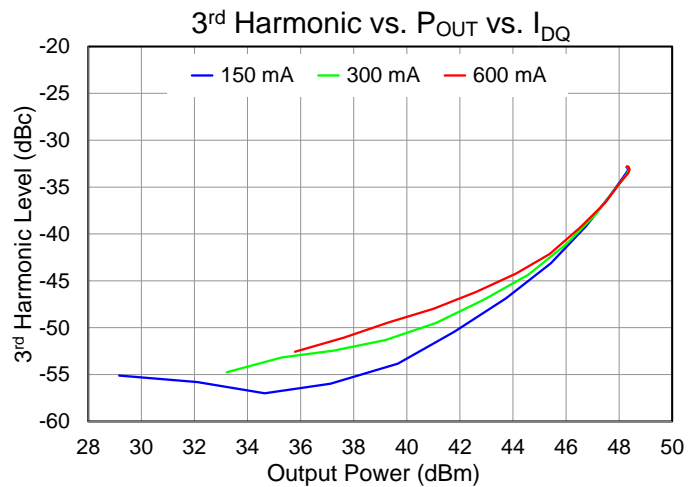
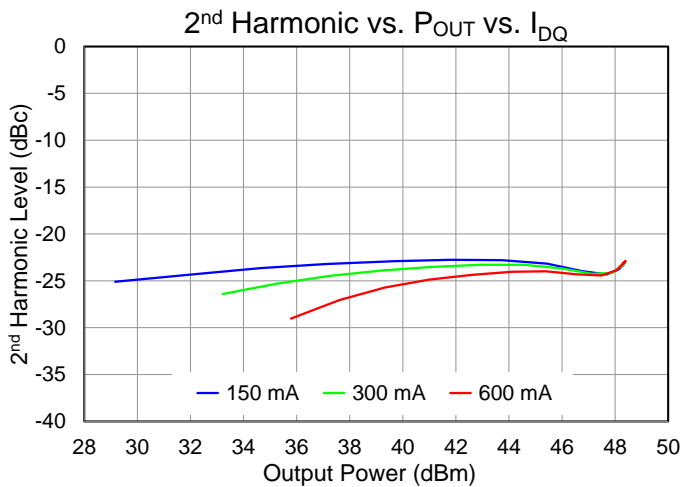
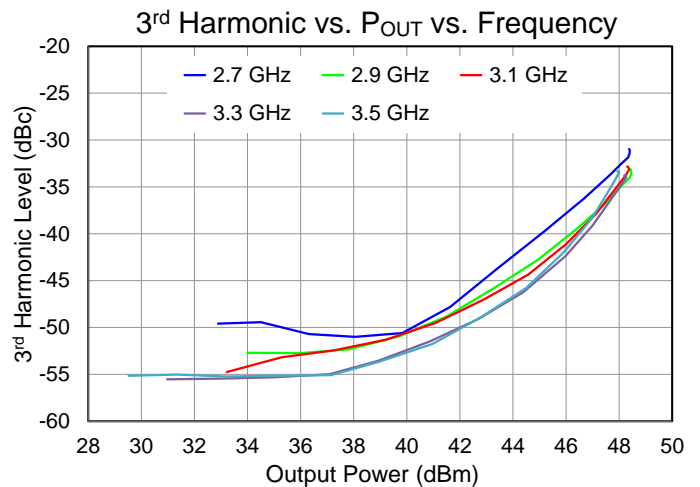
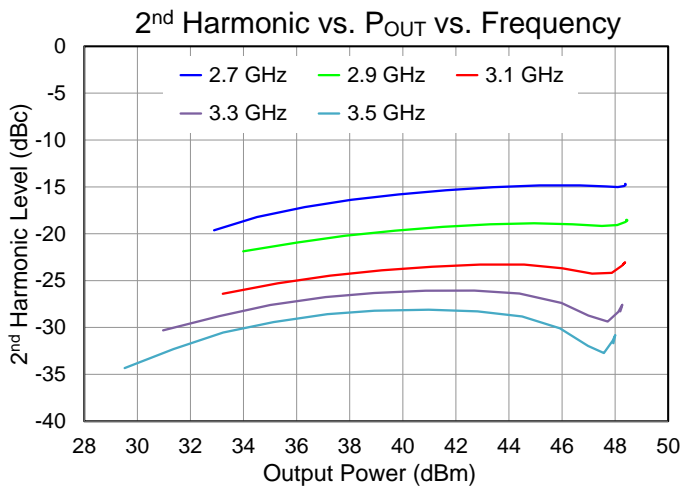
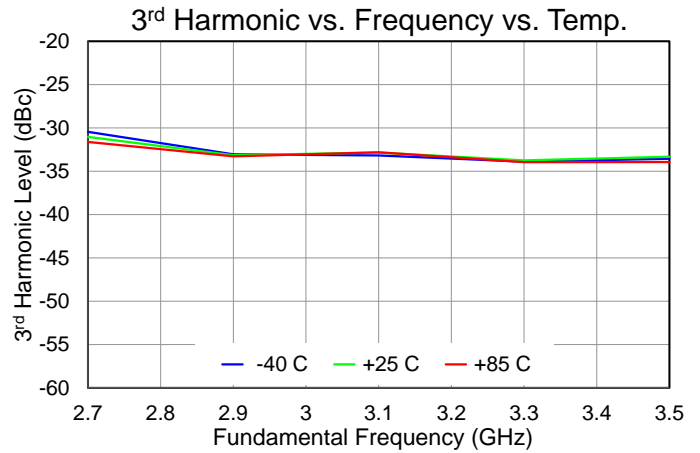
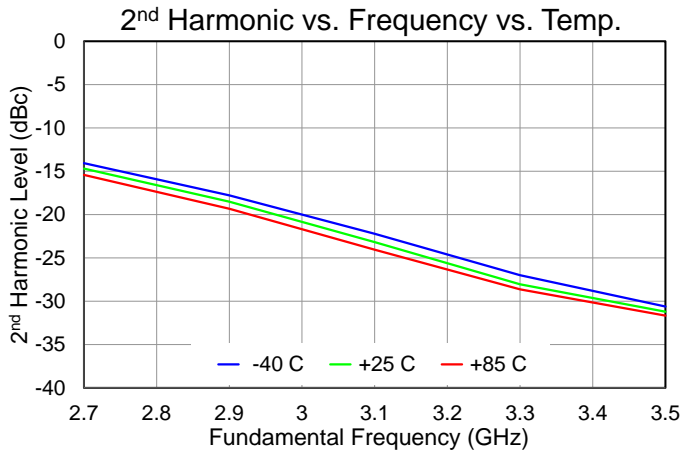

Performance Plots – Small Signal

Test conditions unless otherwise noted: CW $V_D = 50\text{ V}$, $I_{DQ} = 300\text{ mA}$, CW R_{FIN} , $T_{BASE} = +25\text{ }^\circ\text{C}$ (T_{BASE} is backside of QPA1027)

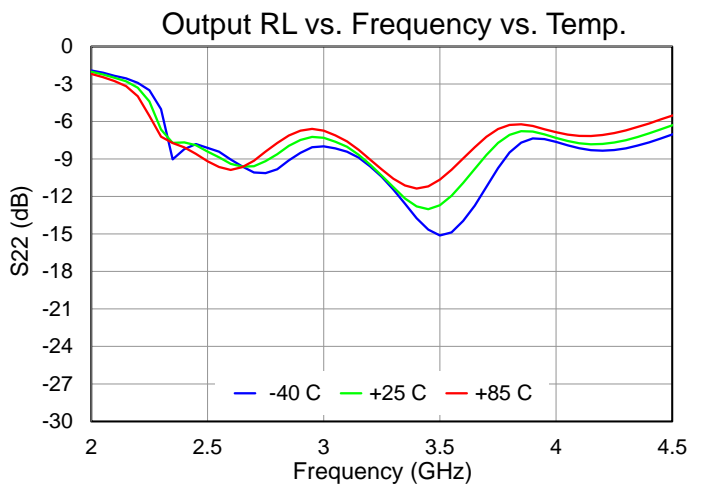
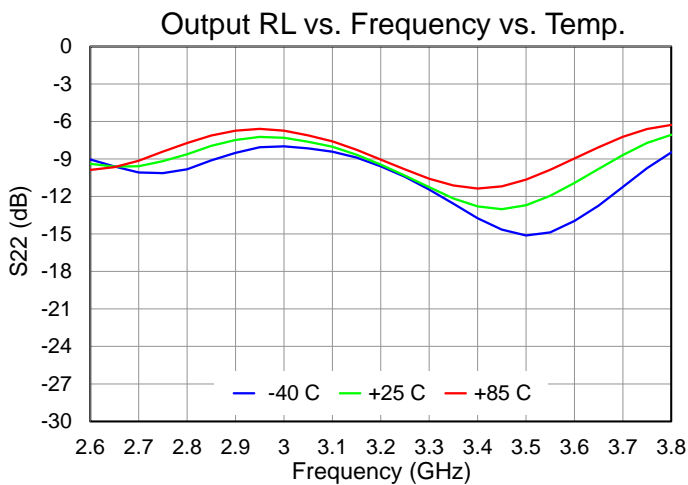
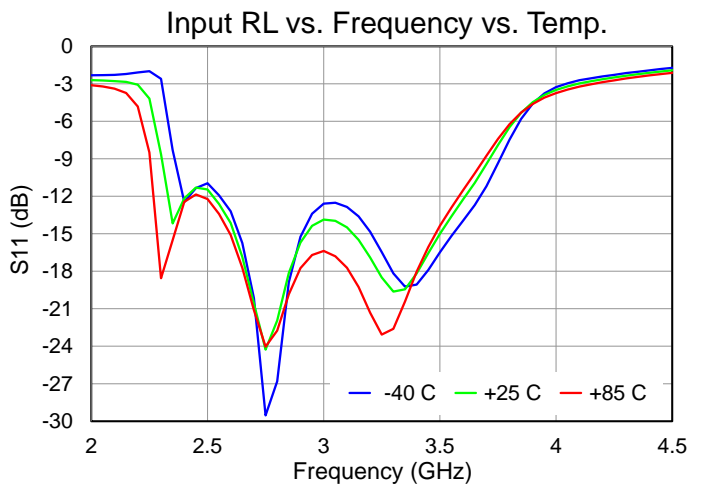
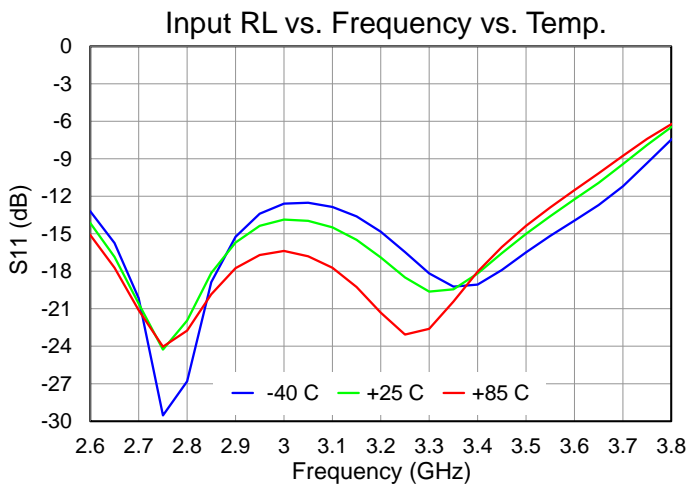
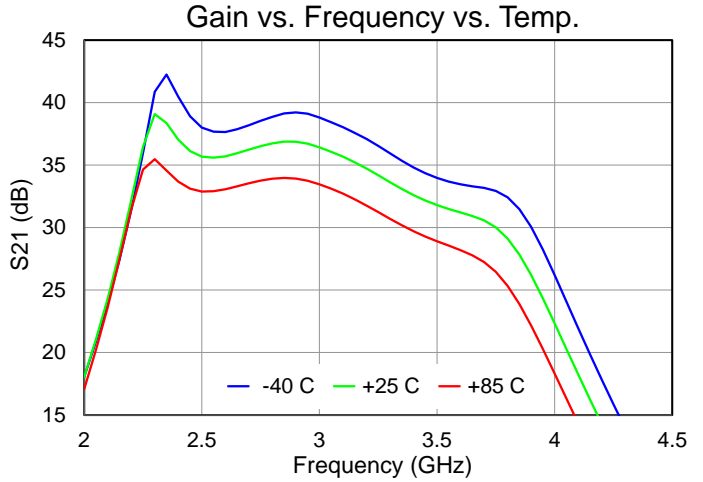
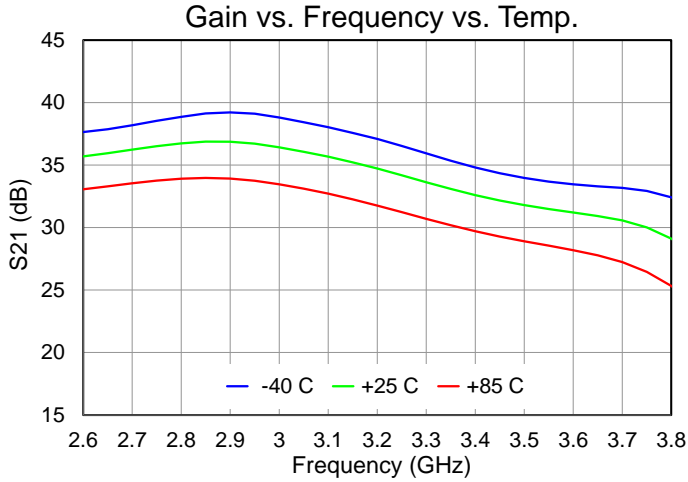

Performance Plots – Small Signal

Test conditions unless otherwise noted: CW $V_D = 50\text{ V}$, $I_{DQ} = 300\text{ mA}$, CW R_{FIN} , $T_{BASE} = +25\text{ }^\circ\text{C}$ (T_{BASE} is backside of QPA1027)

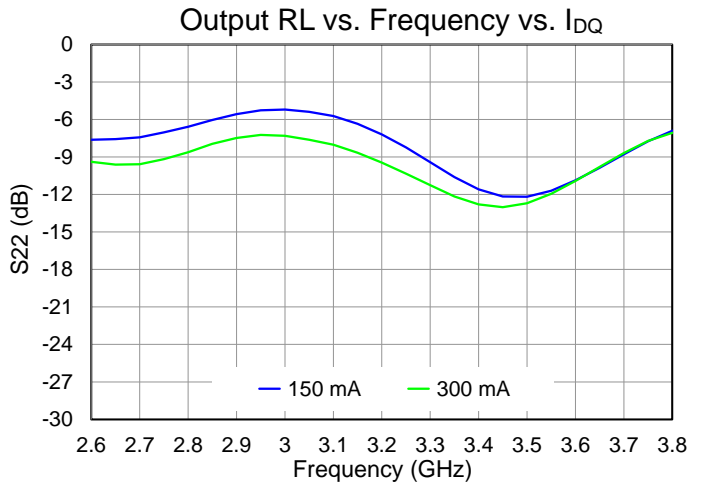
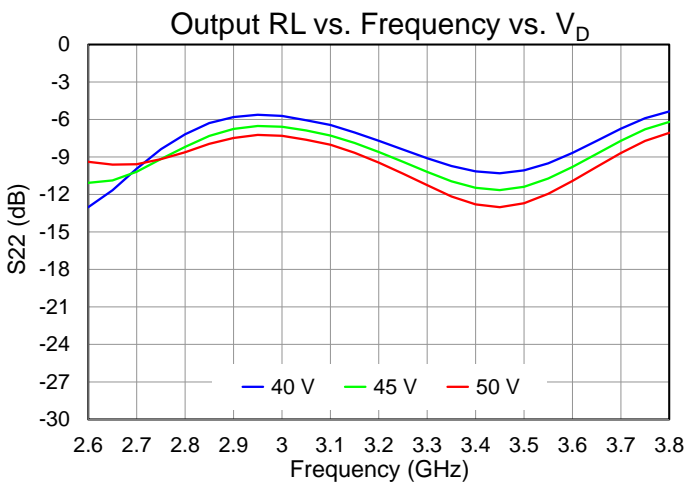
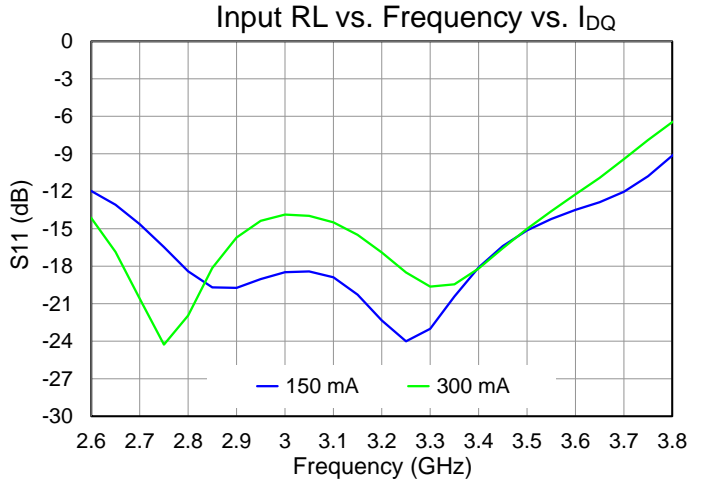
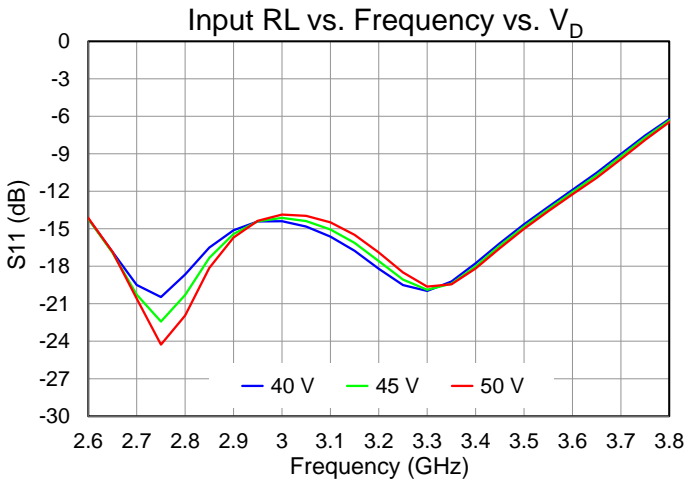
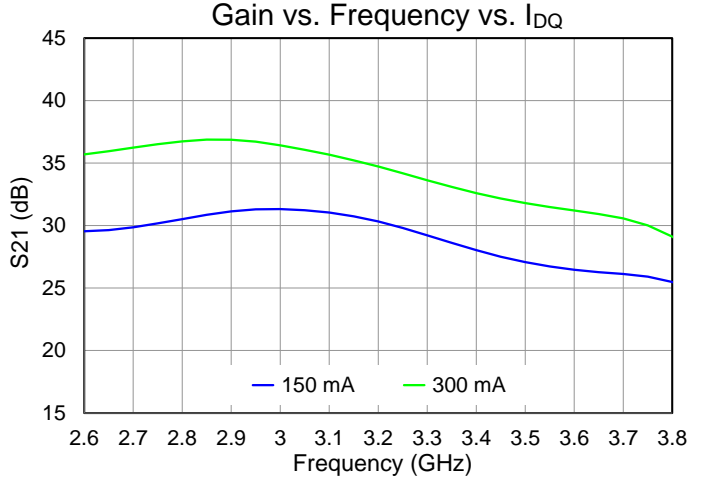
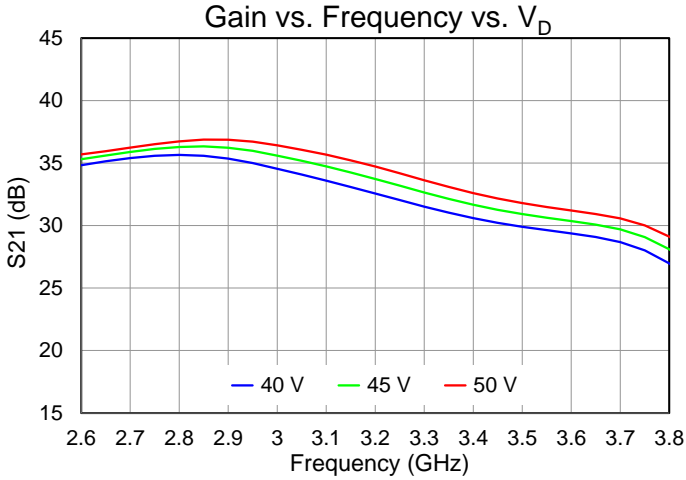

Thermal and Reliability Information

Parameter	Test Conditions	Value	Units
Thermal Resistance (θ_{JC}) ⁽¹⁾	$T_{BASE} = 85\text{ }^{\circ}\text{C}$, Pulsed PW = 100 us, DC = 10%, $V_D = 50\text{ V}$, $I_{DQ} = 300\text{ mA}$, Freq = 3.5 GHz, $I_{D_Drive, peak} \approx 2.45\text{ A}$, $P_{IN} = 26\text{ dBm}$, $P_{OUT} \approx 48\text{ dBm}$, $P_{DISS} = 59\text{ W}$	0.91	$^{\circ}\text{C/W}$
Channel Temperature, T_{CH} (Under RF) ⁽²⁾		138	$^{\circ}\text{C}$
Thermal Resistance (θ_{JC}) ⁽¹⁾	$T_{BASE} = 85\text{ }^{\circ}\text{C}$, Pulsed PW = 700 us, DC = 20%, $V_D = 50\text{ V}$, $I_{DQ} = 300\text{ mA}$, Freq = 3.5 GHz, $I_{D_Drive, peak} \approx 2.35\text{ A}$, $P_{IN} = 26\text{ dBm}$, $P_{OUT} \approx 47.9\text{ dBm}$, $P_{DISS} = 56\text{ W}$	1.55	$^{\circ}\text{C/W}$
Channel Temperature, T_{CH} (Under RF) ⁽²⁾		172	$^{\circ}\text{C}$
Thermal Resistance (θ_{JC}) ⁽¹⁾	$T_{BASE} = 85\text{ }^{\circ}\text{C}$, Pulsed PW = 1000 us, DC = 20%, $V_D = 50\text{ V}$, $I_{DQ} = 300\text{ mA}$, Freq = 3.5 GHz, $I_{D_Drive, peak} \approx 2.3\text{ A}$, $P_{IN} = 26\text{ dBm}$, $P_{OUT} \approx 47.9\text{ dBm}$, $P_{DISS} = 54\text{ W}$	1.71	$^{\circ}\text{C/W}$
Channel Temperature, T_{CH} (Under RF) ⁽²⁾		177	$^{\circ}\text{C}$
Thermal Resistance (θ_{JC}) ⁽¹⁾	$T_{BASE} = 85\text{ }^{\circ}\text{C}$, Pulsed PW = 2000 us, DC = 20%, $V_D = 50\text{ V}$, $I_{DQ} = 300\text{ mA}$, Freq = 3.5 GHz, $I_{D_Drive, peak} \approx 2.3\text{ A}$, $P_{IN} = 26\text{ dBm}$, $P_{OUT} \approx 47.9\text{ dBm}$, $P_{DISS} = 54\text{ W}$	1.86	$^{\circ}\text{C/W}$
Channel Temperature, T_{CH} (Under RF) ⁽²⁾		185	$^{\circ}\text{C}$

Notes:

- Thermal resistance determined to the back of QPA1027 $T_{BASE} = 85\text{ }^{\circ}\text{C}$
- Channel temperature indicated is an IR scan equivalent temperature. Thermal resistance is calculated using this value. Additional information can be found in the Qorvo Applications Note "GaN Device TCHMAX Theta-JC and Reliability Estimates," located here <https://www.qorvo.com/products/d/da006480>

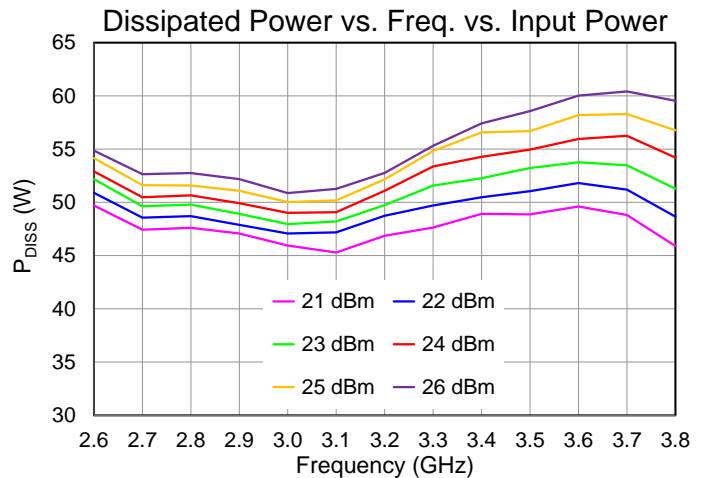
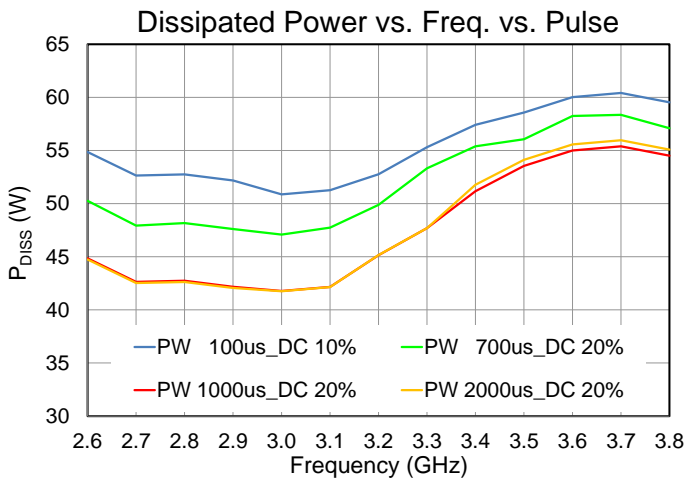

Test conditions unless otherwise noted: Pulsed $V_D = 50\text{ V}$, $I_{DQ} = 300\text{ mA}$, PW = 100 us, DC = 10%, CW $RF_{IN} = 26\text{ dBm}$, $T_{BASE} = +85\text{ }^{\circ}\text{C}$

Applications Circuit (Pulse)

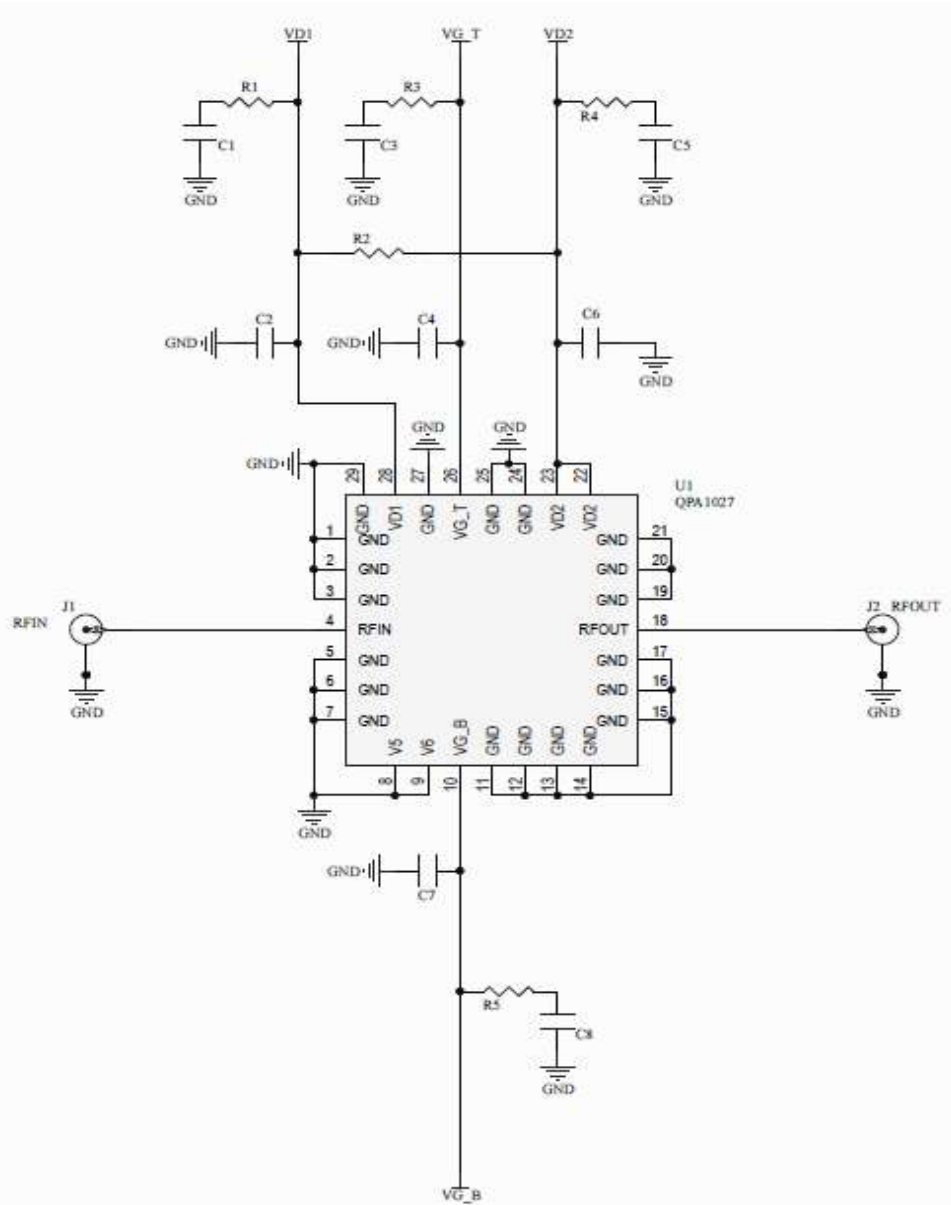

- Note:
1. V_G can be applied to either side; external bypassing required on both sides
 2. Remove R2 to bias V_d 's independently

Bias-Up Procedure

1. Set I_D limit (CW) to 3000 mA, I_G limit to 200 mA
2. Set V_G to -5.0 V
4. Set V_D +50 V
5. Adjust V_G more positive until $I_{DQ} = 300$ mA ($V_G \approx -2.7$ V +/- Typical)

Bias-Down Procedure

1. Turn off RF signal
2. Reduce V_G to -5.0 V. Ensure $I_{DQ} \sim 0$ mA
4. Set V_D to 0 V
5. Turn off V_D supply

Application Evaluation Board (Pulse)

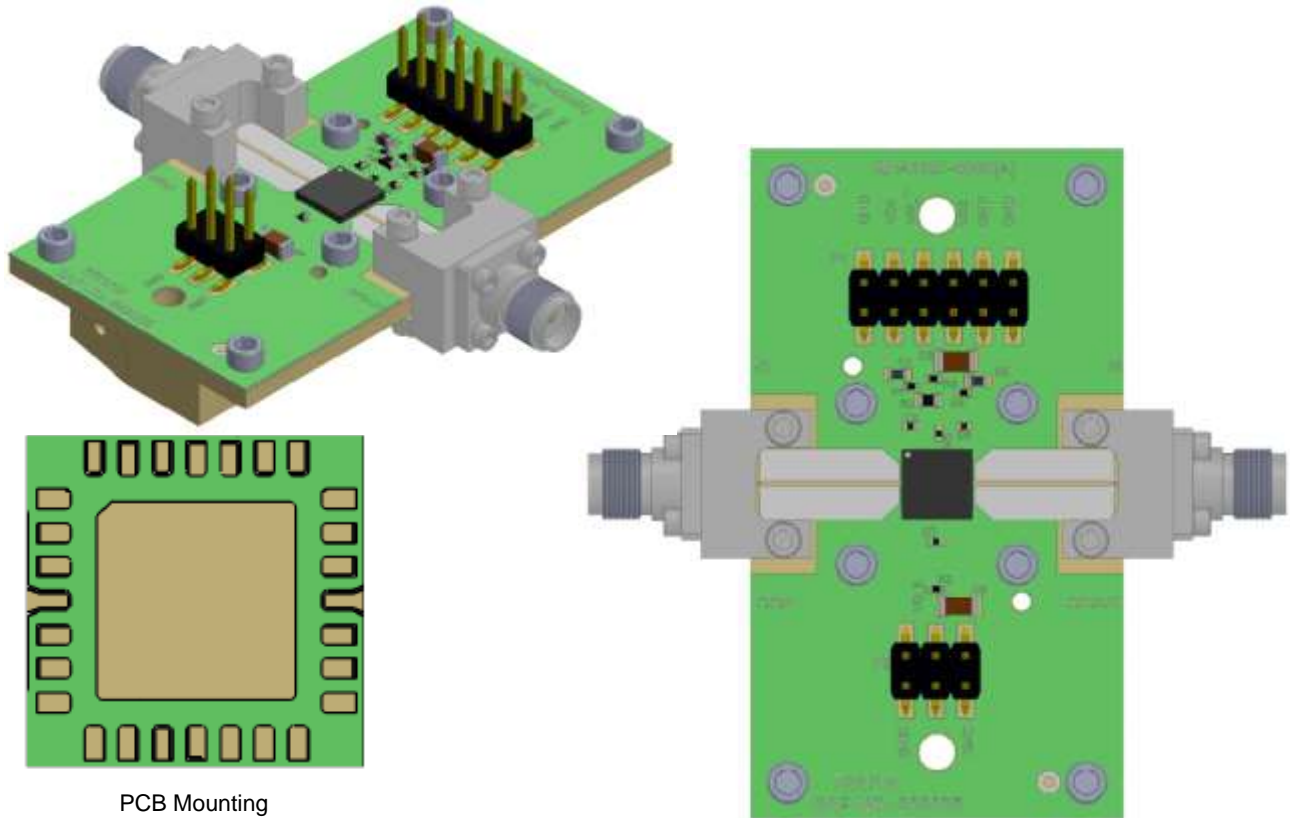

PCB Mounting

Notes:

1. RF PCB is Rogers 4003C; dielectric is 8 mil thick, copper cladding is ½ oz. copper both sides, plated to 1 oz
2. Copper Slug placed under the DUT to improve thermal and electrical performance

Bill of Materials

Reference Des.	Value	Description	Manuf.	Part Number
C1, C5	0.1 uF	CAP, 0.1uF, ±10%, 50V, X7R, 0603	Various	
C2, C4, C6, C7	1000 pF	CAP, 1000pF, ±10%, 100V, X7R, 0402	Various	
C3, C8	10 uF	CAP, 10uF, ±20%, 50V, X5R, 1206	Various	
R1, R4	10 Ω	RES, 10 OHM, 5%, 0.1W, 0402	Various	
R2	0 Ω	RES, 0 OHM, 0.1W, 0603	Various	
R3, R5	0 Ω	RES, 0 OHM, JMPR, 0402	Various	
H1, H2	-	Header, connector 2x6, SMD		
J1, J2	-	Connector, Female, End Launch, 2.9mm	Southwest Microwave	1092-01A-5
S1 – S8		Screw, cap, socket head, 2-56x1/8"		
PCB	-	Rogers 4003C, 8 mil dielectric, 1 oz. copper (gold plated), 2 layers	Rogers Corp.	Custom
Carrier	-	T-Carrier, Copper C110, 1.248 x 2.246 x 0.275"		Custom
Solder	-	Paste, solder, syntech, Sn62/Pb36/Ag2		
Epoxy	-	Preform Epoxy, 0.986 x 1.996 x 0.003T		

Mechanical Information

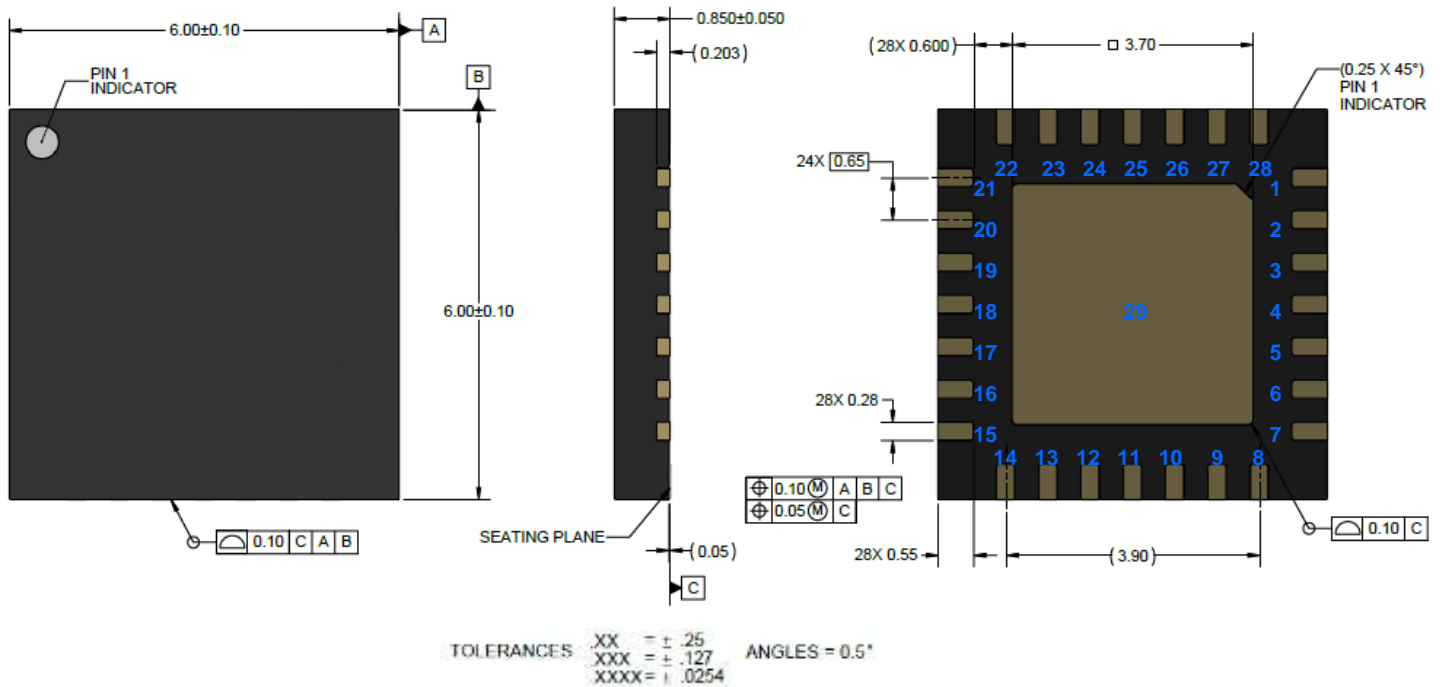

Notes: unless otherwise specified;

1. Dimensions: millimeters (mm)
2. Package leads are gold (Au) plated; Part is mold encapsulated
3. Marking: YY is calendar year; WW is assembly week; MXXX is batch ID

Pin Description

Pin Number	Symbol	Description
1-3, 5-9, 11-17, 19-21, 24-25, 27	N/C	No internal connection. Connect pads to PCB ground
4	RF Input	RF Input. Matched to 50Ω ; DC blocked; DC shorted to ground
10, 26	V_G	Gate voltage. External bypassing required; refer to page 17 for recommendation
18	RF Output	RF Output. Matched to 50Ω ; DC blocked
22, 23	V_{D2}	Drain voltage for stage 2. External bypassing required; refer to page 17 for recommendation
28	V_{D1}	Drain voltage for stage 1. External bypassing required; refer to page 17 for recommendation
29	Center Pad	Ground connection

Tape and reel Information

Standard T/R size = 250 pieces on a 7" reel

Dimensions: millimeters (mm)

Tolerances unless otherwise noted: .X = ± .2; .XX = ± .10

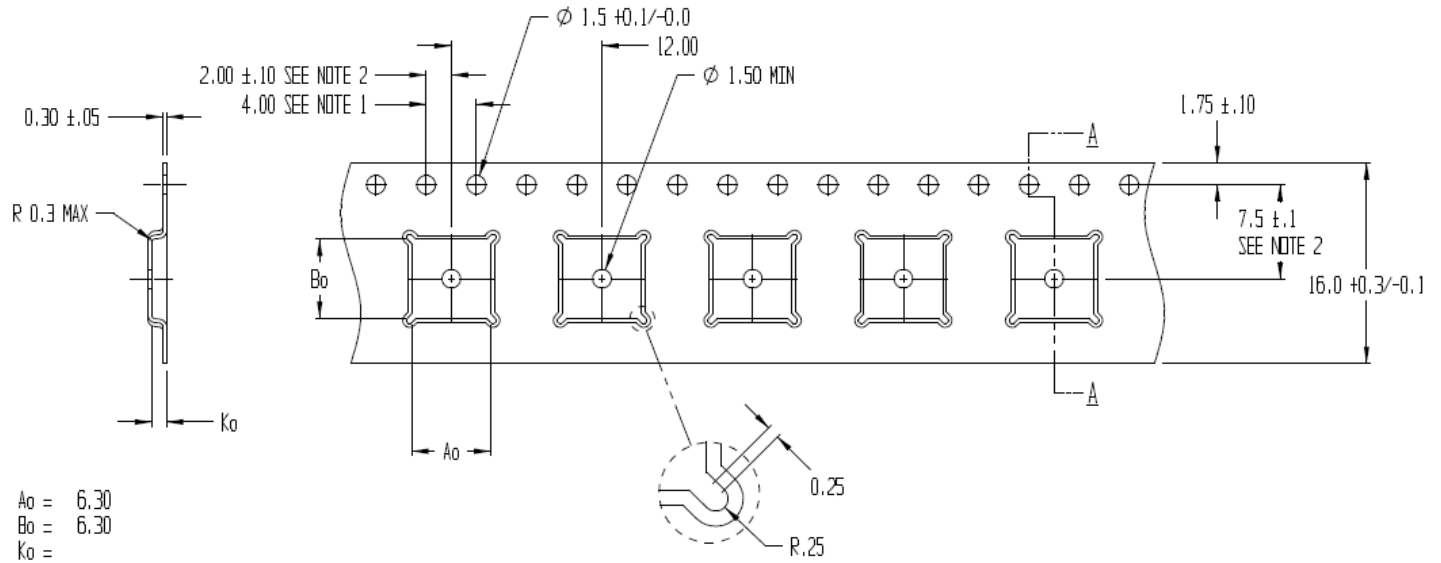

NOTES:

1. 10 SPROCKET HOLE PITCH CUMULATIVE TOLERANCE ± 0.2
2. POCKET POSITION RELATIVE TO SPROCKET HOLE MEASURED AS TRUE POSITION OF POCKET, NOT POCKET HOLE
3. Ao AND Bo ARE CALCULATED ON A PLANE AT A DISTANCE "R" ABOVE THE BOTTOM OF THE POCKET.

Solderability

- Compatible with the latest version of J-STD-020, Lead-free solder, 260 °C
- Do not expose the package lid to temperatures > 280 °C

Recommended Soldering Temperature Profile

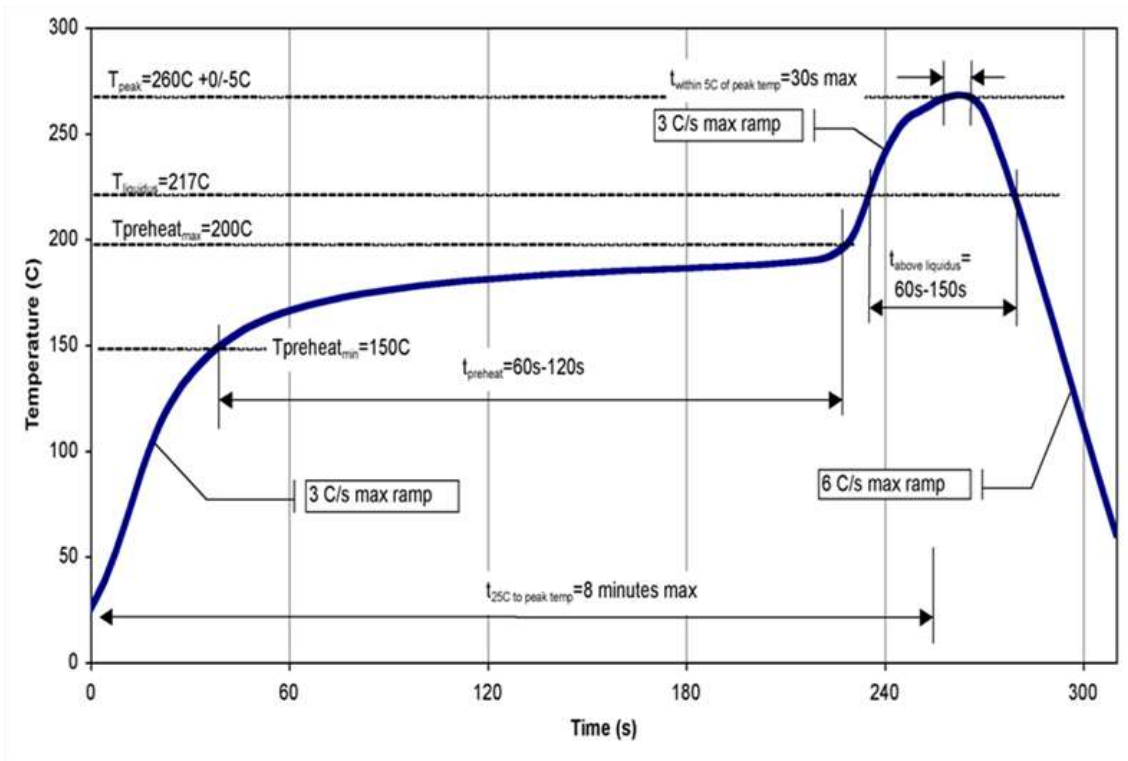

Handling Precautions

Parameter	Rating	Standard
ESD – Human Body Model (HBM)	1A	ANSI/ESD/JEDEC JS-001
ESD – Charged Device Model (CDM)	C3	ANSI/ESD/JEDEC JS-002
MSL – Moisture Sensitivity Level	3	IPC/JEDEC J-STD-020



Caution!
ESD-Sensitive Device

RoHS Compliance

This product is compliant with the 2011/65/EU RoHS directive (Restrictions on the Use of Certain Hazardous Substances in Electrical and Electronic Equipment), as amended by Directive 2015/863/EU.

This product also has the following attributes:

- Lead Free
- Halogen Free (Chlorine, Bromine)
- Antimony Free
- TBBP-A (C₁₅H₁₂Br₄O₂) Free
- PFOS Free
- SVHC Free

Contact Information

For the latest specifications, additional product information, worldwide sales and distribution locations:

Web: www.qorvo.com

Tel: 1-844-890-8163

Email: customer.support@qorvo.com

Important Notice

The information contained herein is believed to be reliable; however, Qorvo makes no warranties regarding the information contained herein and assumes no responsibility or liability whatsoever for the use of the information contained herein. All information contained herein is subject to change without notice. Customers should obtain and verify the latest relevant information before placing orders for Qorvo products. The information contained herein or any use of such information does not grant, explicitly or implicitly, to any party any patent rights, licenses, or any other intellectual property rights, whether with regard to such information itself or anything described by such information. **THIS INFORMATION DOES NOT CONSTITUTE A WARRANTY WITH RESPECT TO THE PRODUCTS DESCRIBED HEREIN, AND QORVO HEREBY DISCLAIMS ANY AND ALL WARRANTIES WITH RESPECT TO SUCH PRODUCTS WHETHER EXPRESS OR IMPLIED BY LAW, COURSE OF DEALING, COURSE OF PERFORMANCE, USAGE OF TRADE OR OTHERWISE, INCLUDING THE IMPLIED WARRANTIES OF MERCHANTABILITY AND FITNESS FOR A PARTICULAR PURPOSE.**

Without limiting the generality of the foregoing, Qorvo products are not warranted or authorized for use as critical components in medical, life-saving, or life-sustaining applications, or other applications where a failure would reasonably be expected to cause severe personal injury or death.

Copyright 2021 © Qorvo, Inc. | Qorvo is a registered trademark of Qorvo, Inc.