

Product Overview

The SPF5189Z is a high performance pHEMT Low-Noise MMIC amplifier designed for operation from 50MHz to 4000MHz. The on-chip active bias network provides stable current over temperature and process threshold voltage variations. The SPF5189Z offers ultra-low noise figure and high linearity performance in a gain block configuration. Its single-supply operation and integrated matching networks make implementation remarkably simple. A high maximum input power specification makes it ideal for high dynamic range receivers.



SOT-89 Package

Key Features

- Ultra-Low Noise Figure 0.60dB at 900MHz
- Gain 18.7dB at 900MHz
- High Linearity; Output IP3 +39.5dBm at 1960MHz
- P1dB +22.7dBm at 1960MHz
- Single DC Supply Operation +5V 90mA
- Flexible DC Supply Options +3V to +5V
- Broadband Internal Matching

Functional Block Diagram

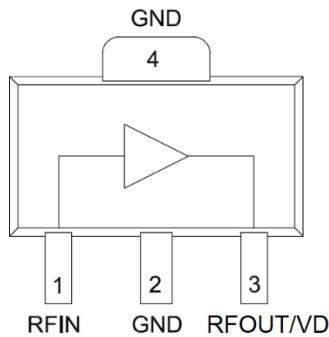

Top View

Applications

- Cellular, PCS, W-CDMA, ISM & WiMAX Receivers
- PA Driver Amplifiers
- Low Noise, High Linearity Gain Block Applications

Ordering Information

Part No.	Description
SPF5189Z	1,000 pieces on a 7" reel
SPF5189ZPCK1	900MHz Evaluation Board with 5-piece Sample Bag
SPF5189ZPCK2	1900MHz Evaluation Board with 5-piece Sample Bag

Absolute Maximum Ratings

Parameter	Rating
Maximum Storage Temperature Range	-60 °C to +150 °C
Device Voltage (VD)	+5.5 V
Device Current (ID)	120 mA
RF Input Power	27 dBm
Maximum Power Dissipation	660 mW
Junction Temperature (T _J)	+150 °C

Exceeding any one or a combination of the Absolute Maximum Rating conditions may cause permanent damage to the device. Extended application of Absolute Maximum Rating conditions to the device may reduce device reliability.

Recommended Operating Conditions

Parameter	Min	Typ	Max	Units
Device Voltage (VD)	+3	+5	+5.25	V
T _{LEAD}	-40		+85	°C

Electrical specifications are measured at specified test conditions. Specifications are not guaranteed over all recommended operating conditions.

Electrical Specifications

Parameter	Conditions ⁽¹⁾	Min	Typ	Max	Units
Gain, Small Signal	900 MHz		18.7		dB
	1960 MHz	11.3	12.8	14.3	dB
Input Return Loss	900 MHz		17.5		dB
	1960 MHz	10.0	18.5		dB
Output Return Loss	900 MHz		16.0		dB
	1960 MHz	11.0	15.0		dB
Reverse Isolation	900 MHz		24.0		dB
	1960 MHz		18.0		dB
Output P1dB	900 MHz		22.4		dBm
	1960 MHz	20.7	22.7		dBm
Output IP3 ⁽²⁾	900 MHz		38.5		dBm
	1960 MHz	36.0	39.5		dBm
Noise Figure	900 MHz		0.55		dB
	1960 MHz		0.80	1.10	dB
Device Operating Current, ID	Pin 3	75	90	105	mA
Thermal Resistance, θ _{Jc}	Junction to Lead		65		°C/W

Notes:

1. Test conditions unless otherwise noted: VD = +5.0V, IDQ = 90mA, T_{LEAD} = +25 °C, 50 Ω test system on EVB circuit
2. P_{OUT} = 0 dBm/100Hz, Δf = 1 MHz

Typical RF Performance on Evaluation Boards

Parameter	0.8GHz	0.9GHz	1.0GHz	1.7GHz	1.8GHz	1.9GHz	2.0GHz	2.1GHz	2.2GHz	Unit
Small Signal Gain	19.6	18.7	17.9	13.8	13.5	12.9	12.7	12.2	11.9	dB
Noise Figure	0.52	0.55	0.79	0.75	0.81	0.83	0.90	0.91	0.98	dB
Output IP3	38.4	38.5	39.0	39.2	39.5	39.5	39.8	39.8	39.9	dBm
Output P1dB	22.3	22.4	22.5	22.6	22.6	22.7	22.7	22.7	22.7	dBm
Input Return Loss	17.1	17.5	17.5	17.5	17.5	18.5	18.5	18.5	18.0	dB
Output Return Loss	16.0	16.0	15.5	14.0	14.0	14.5	15.0	15.5	16.0	dB
Reverse Isolation	24.5	24.0	23.0	18.5	18.5	18.0	18.0	17.5	17.0	dB

Test conditions: VD +5V, ID 90mA, OIP3 0dBm/100Hz Δf 1MHz, T_{LEAD} +25°C, 50Ω system impedance

900MHz Evaluation Board – SPF5189ZPCK1

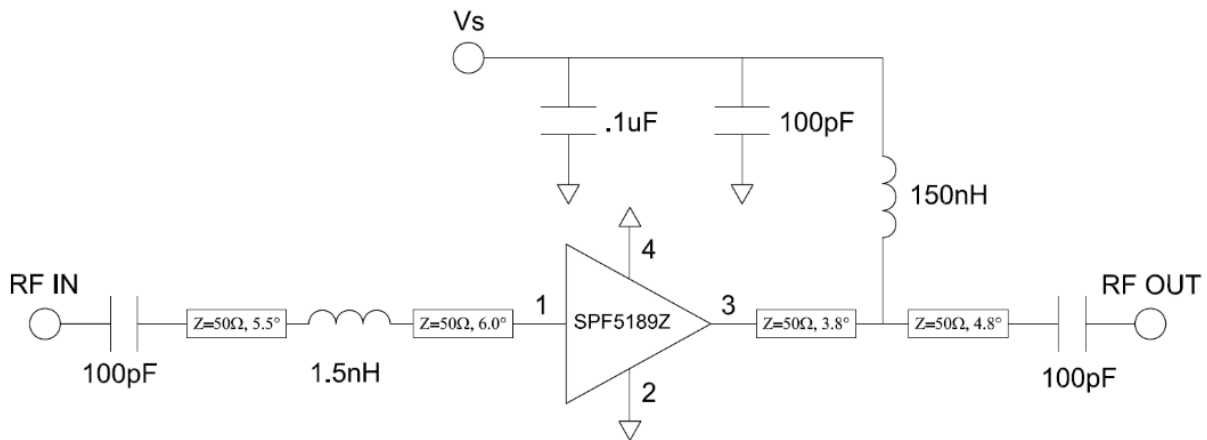
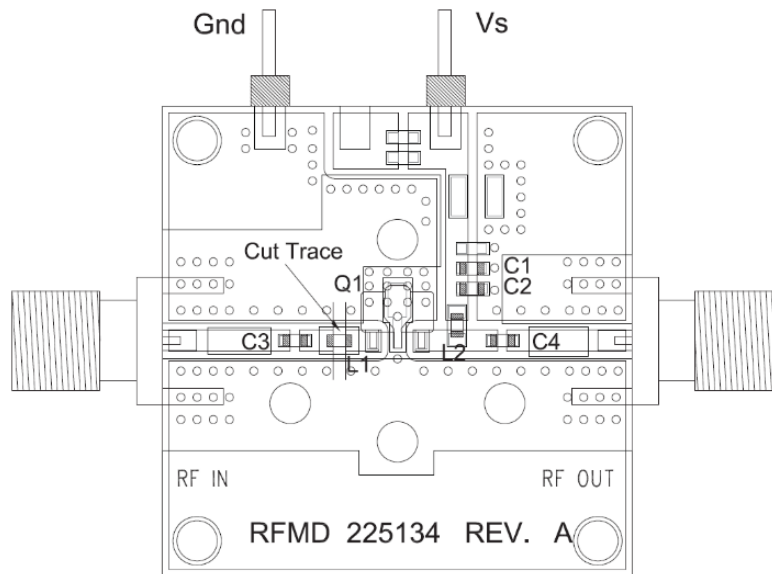

Electrical lengths refer to 900MHz; from the center of shunt components and cuts on series transmission lines

Bill of Material – SPF5189ZPCK1

Reference Des.	Value	Description	Manuf.	Part Number
PCB	-	Printed Circuit Board	Qorvo	225134
Q1	-	AMP, GaAs pHEMT, SOT-89	Qorvo	SPF5189Z
C1	0.1 μ F	CAP, 0.1 μ F, 10%, 16V, X7R, 0603	Murata	GRM188R71C104KA01D
C2, C3, C4	100 pF	CAP, 100 pF, 5%, 50V, COG, 0603	Murata	GRM188R71H101JA01D
L1	1.5 nH	IND, 1.5 nH, \pm 0.03 nH, M/L, 0603	Taiyo Yuden	LG HK16081N5S
L2	150 nH	IND, 150 nH, 5%, W/W, 0603	Coilcraft	0603CS-R15XJLW
J1, J2	-	CONN, SMA, END LNCH, FLT, 0.062"	Cinch	142-0701-821

900MHz Performance Plots – SPF5189ZPCK1

Test conditions unless otherwise noted: $V_D = +5V$, $I_D = 90mA$, $P_{out} 0dBm/tones \Delta f 1MHz$ for OIP3, 50Ω test system, $T_{LEAD} = +25^\circ C$

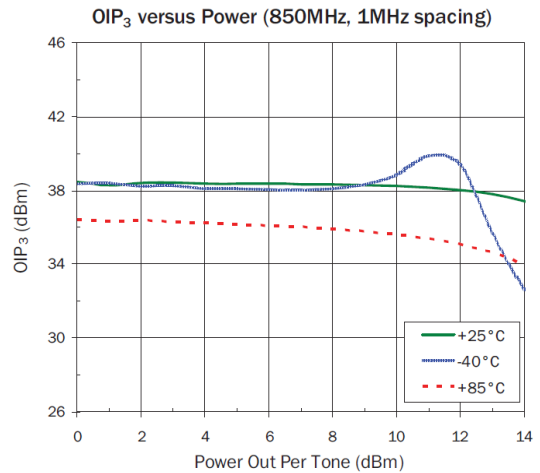
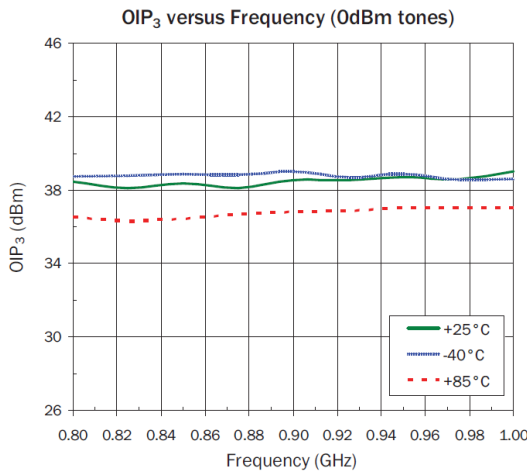
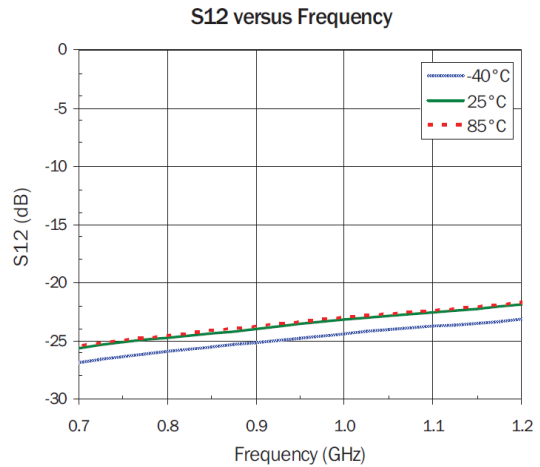
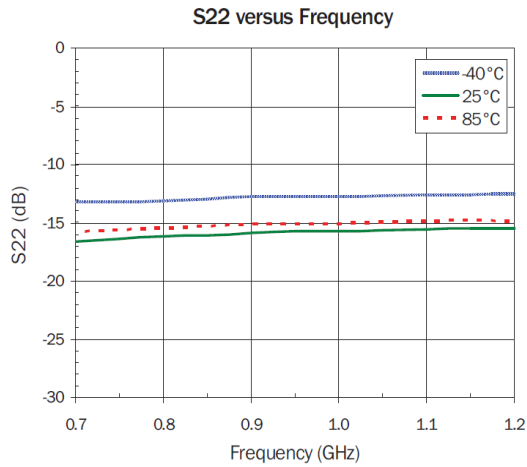
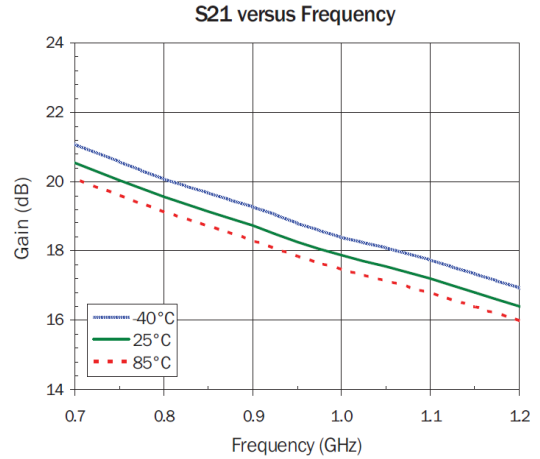
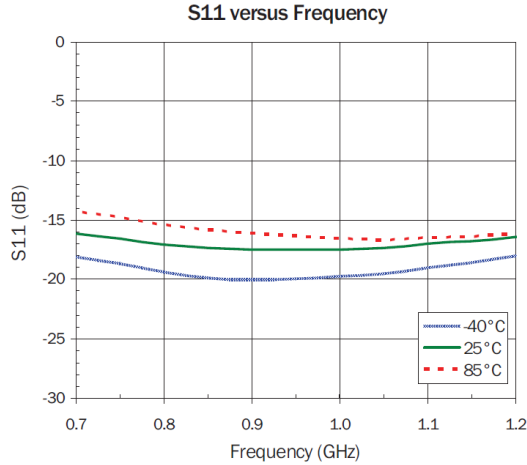

900MHz Performance Plots – SPF5189ZPCK1 (continued)

Test conditions unless otherwise noted: $V_D = +5V$, $I_D = 90mA$, $P_{out} 0dBm/$ tone Δf 1MHz for OIP3, 50Ω test system, $T_{LEAD} = +25^\circ C$

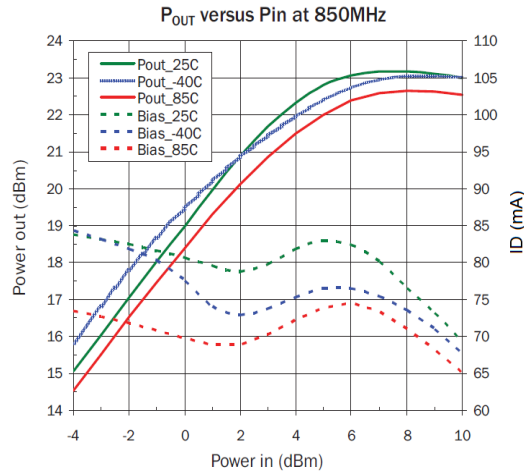
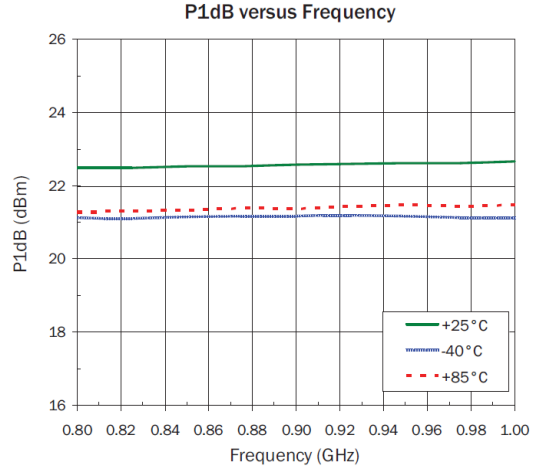
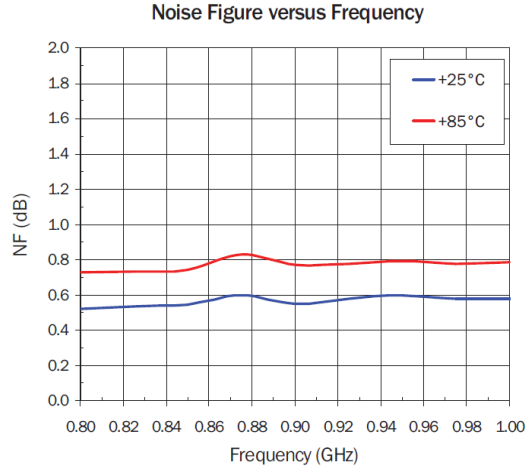

1900MHz Evaluation Board – SPF5189ZPCK2

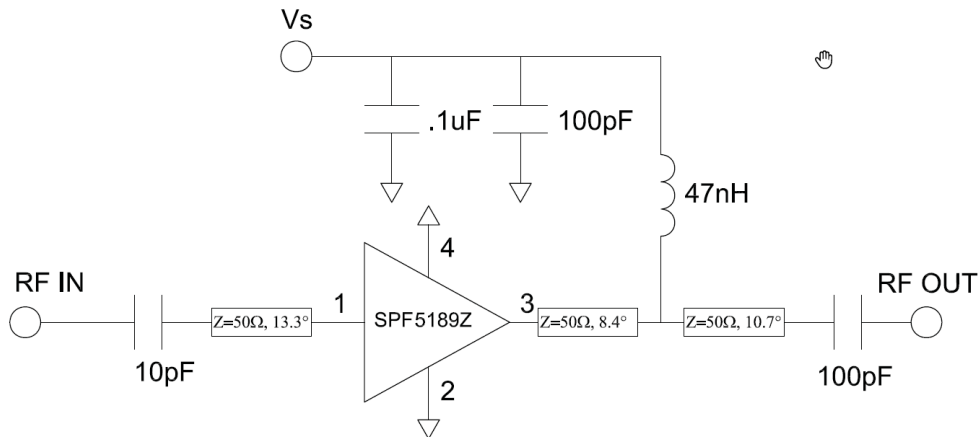
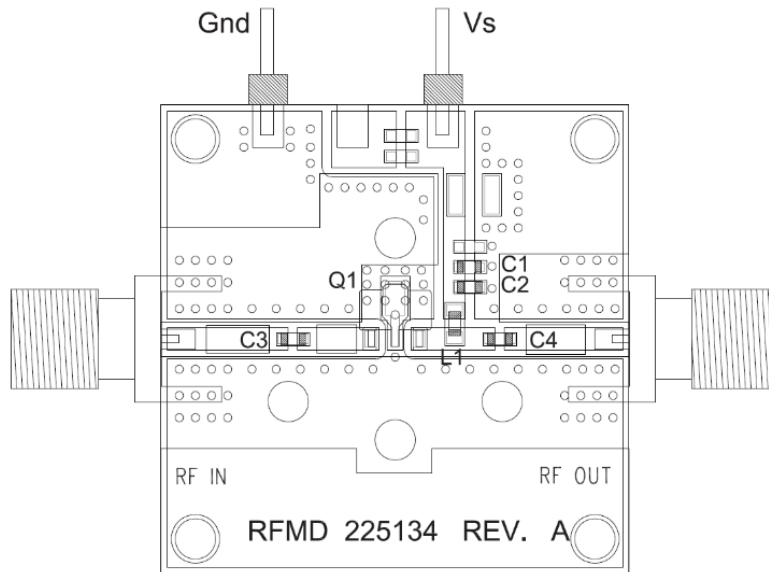

Electrical lengths refer to 2GHz, from the center of shunt components and cuts on series transmission lines

Bill of Material – SPF5189ZPCK2

Reference Des.	Value	Description	Manuf.	Part Number
PCB	-	Printed Circuit Board	Qorvo	225134
Q1	-	AMP, GaAs pHEMT, SOT-89	Qorvo	SPF5189Z
C1	0.1 μ F	CAP, 0.1 μ F, 10%, 16V, X7R, 0603	Murata	GRM188R71C104KA01D
C2, C4	100 pF	CAP, 100 pF, 5%, 50V, COG, 0603	Murata	GRM188R71H101JA01D
L1	47 nH	IND, 47 nH, 7%, W/W, 0603	Coilcraft	0603HC-47NXJRW
J1, J2	-	CONN, SMA, END LNCH, FLT, 0.062"	Cinch	142-0701-821

Performance Plots – 1900MHz Evaluation Board

Test conditions unless otherwise noted: $V_D = +5V$, $I_D = 90mA$, $50\ \Omega$ test system, $T_{LEAD} = +25\ ^\circ C$

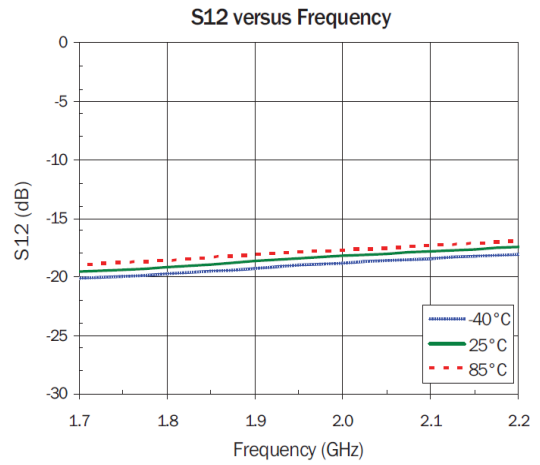
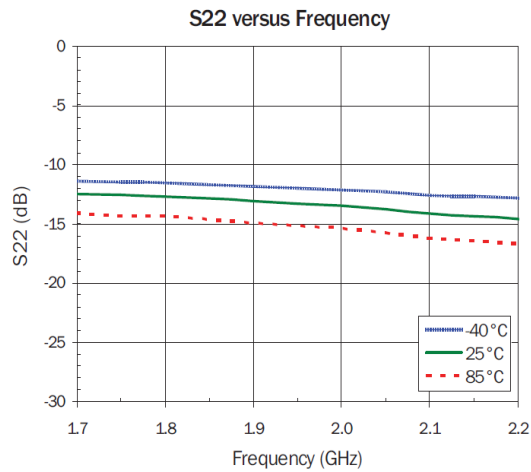
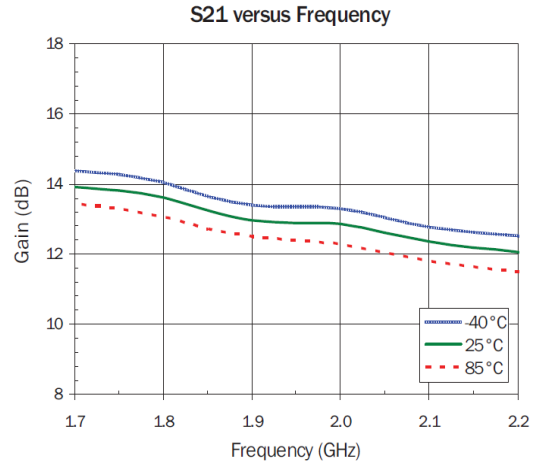
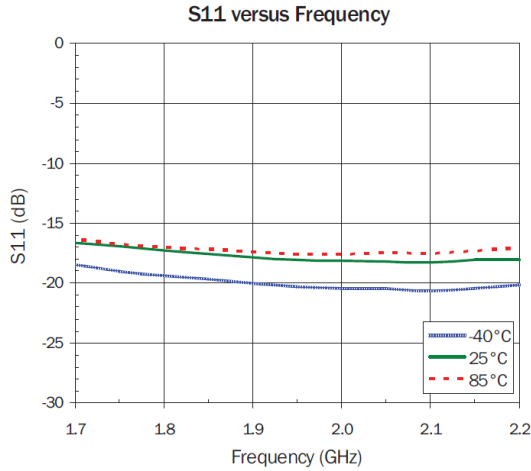

Performance Plots – 1900MHz Evaluation Board (continued)

Test conditions unless otherwise noted: $V_D = +5V$, $I_D = 90mA$, $P_{out} 0dBm/$ tone $\Delta f 1MHz$ for OIP3, 50Ω test system, $T_{LEAD} = +25^\circ C$

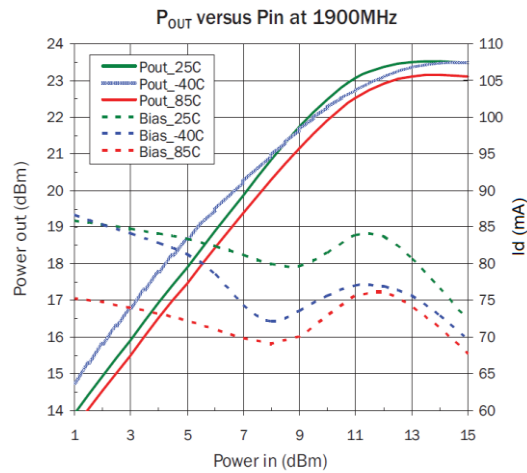
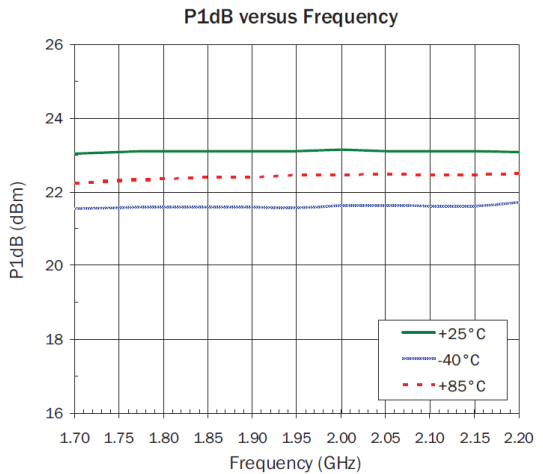
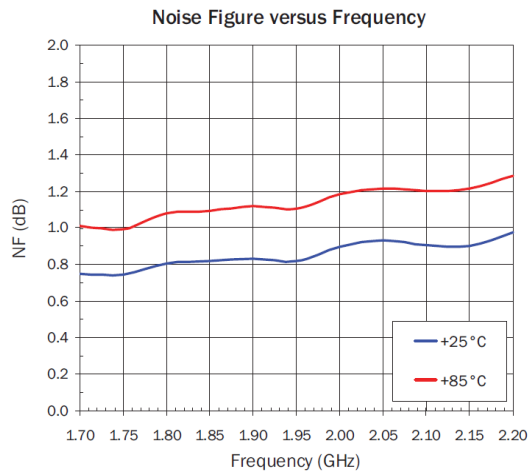
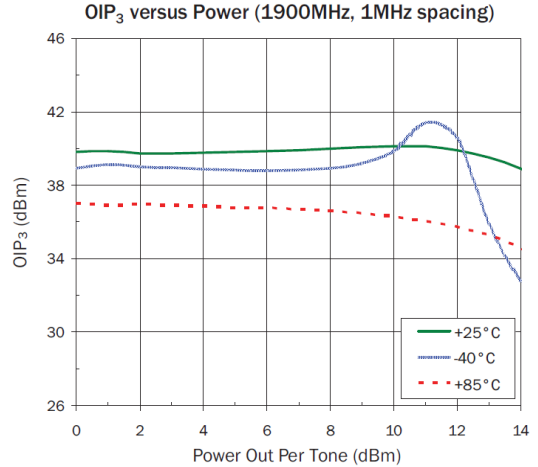
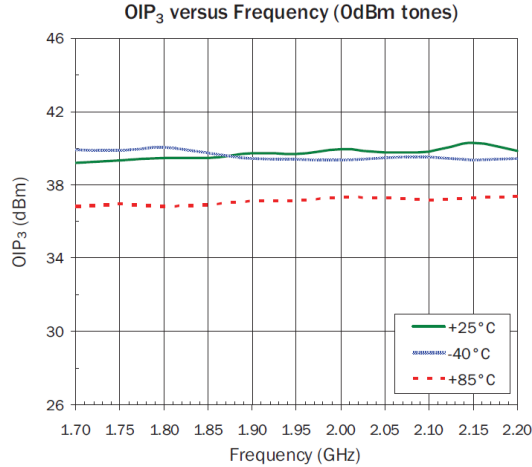

SPF5189Z Characteristic Plots – Reference Plane at Device Leads

Test conditions unless otherwise noted: $V_D = +5V$, $I_D = 90mA$, 50Ω test system, BIAS Tees where applied, $T_{LEAD} = +25^\circ C$

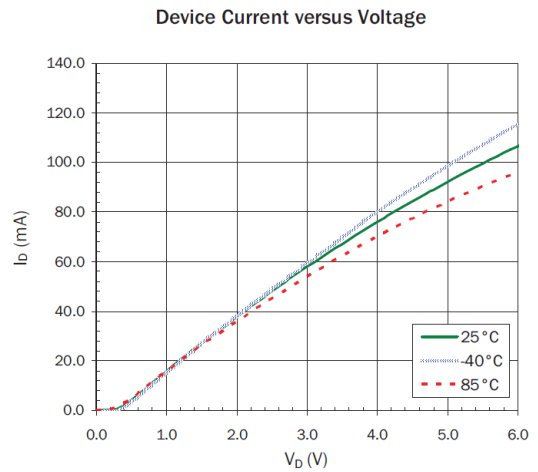
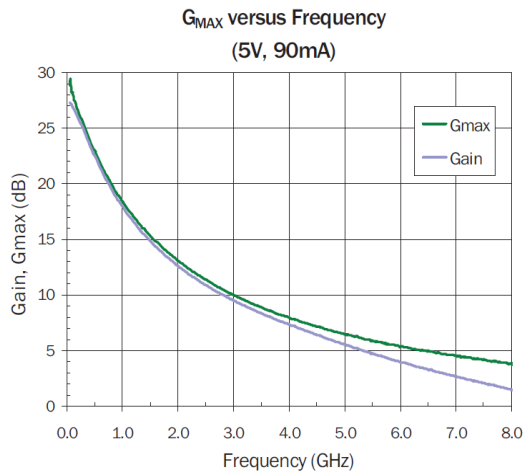
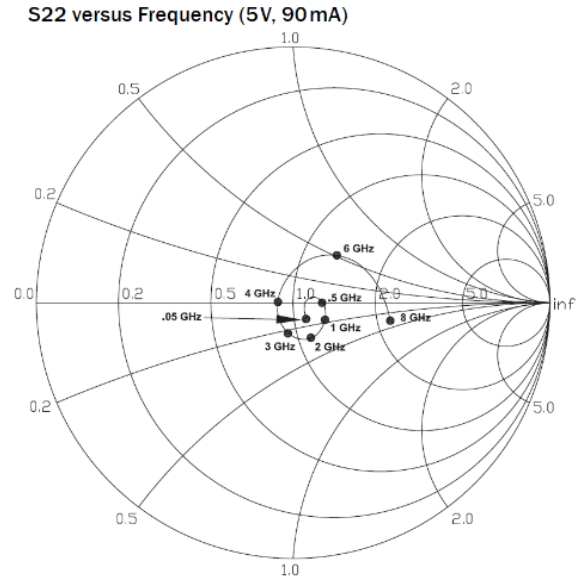
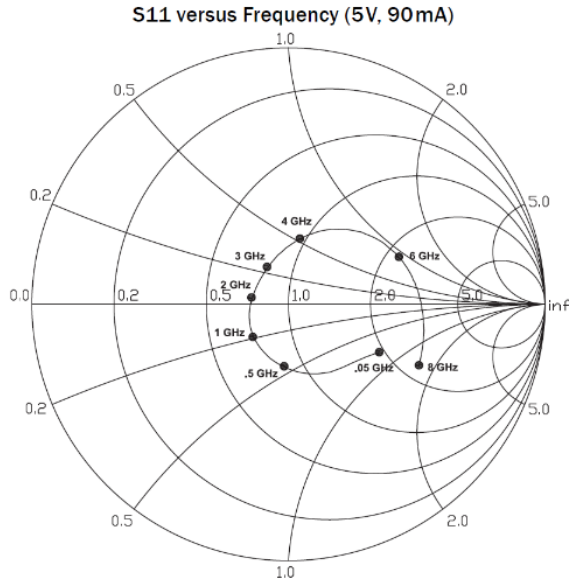

Pad Configuration and Description

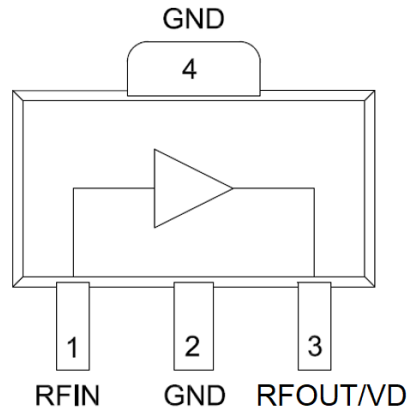

Top View

Pad No.	Label	Description
1	RFIN	RF input, External DC Blocking capacitor required.
3	RFOUT / VD	RF output and DC Supply input, External DC Block capacitor required.
2, 4 Backside Paddle	GND	RF and DC ground, Use recommended via hole pattern to minimize inductance and thermal resistance. See PCB Mounting Pattern for suggested footprint.

Package Marking and Dimensions

Marking: Part Number – SPF5189Z
Trace Code – Assigned by sub-contractor

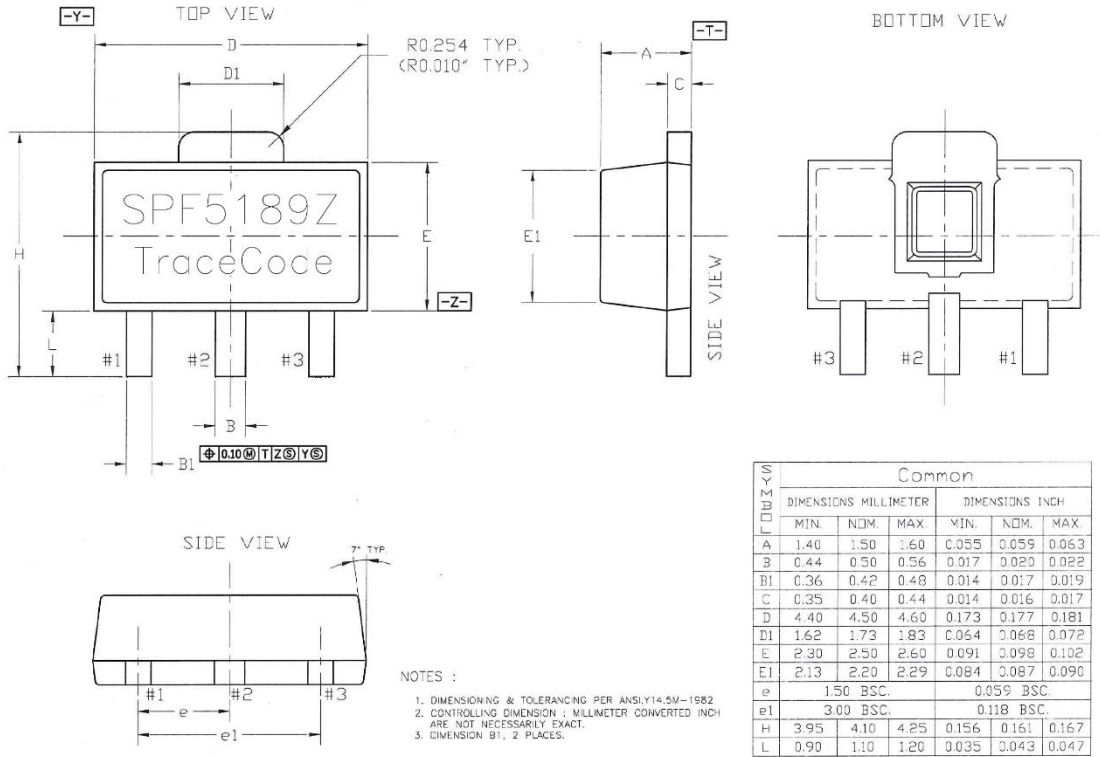

- Notes:
1. All dimensions are in millimeters & inches. Angles are in degrees.
 2. The terminal #1 identifier and terminal numbering conform to JESD 95-1 SPP-012.

PCB Mounting Pattern

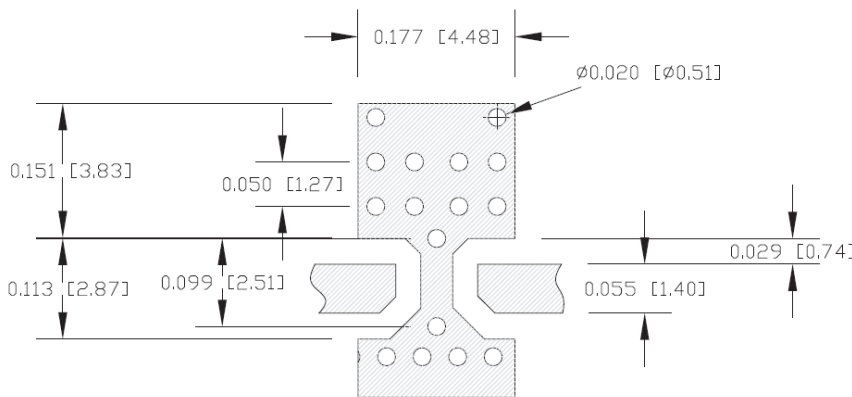

Optimum Mount with Screws

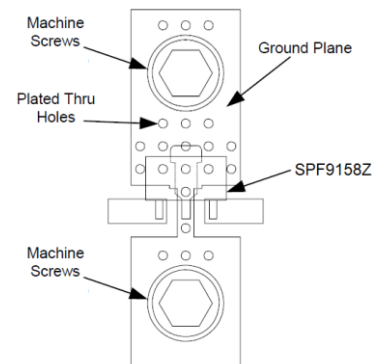

- Notes:
1. All dimensions are in millimeters. Angles are in degrees.
 2. Use 1 oz. copper minimum for top and bottom layer metal.
 3. Ensure good package backside paddle solder attach for reliable operation and best electrical performance.

Tape and Reel Information – Carrier and Cover Tape Dimensions

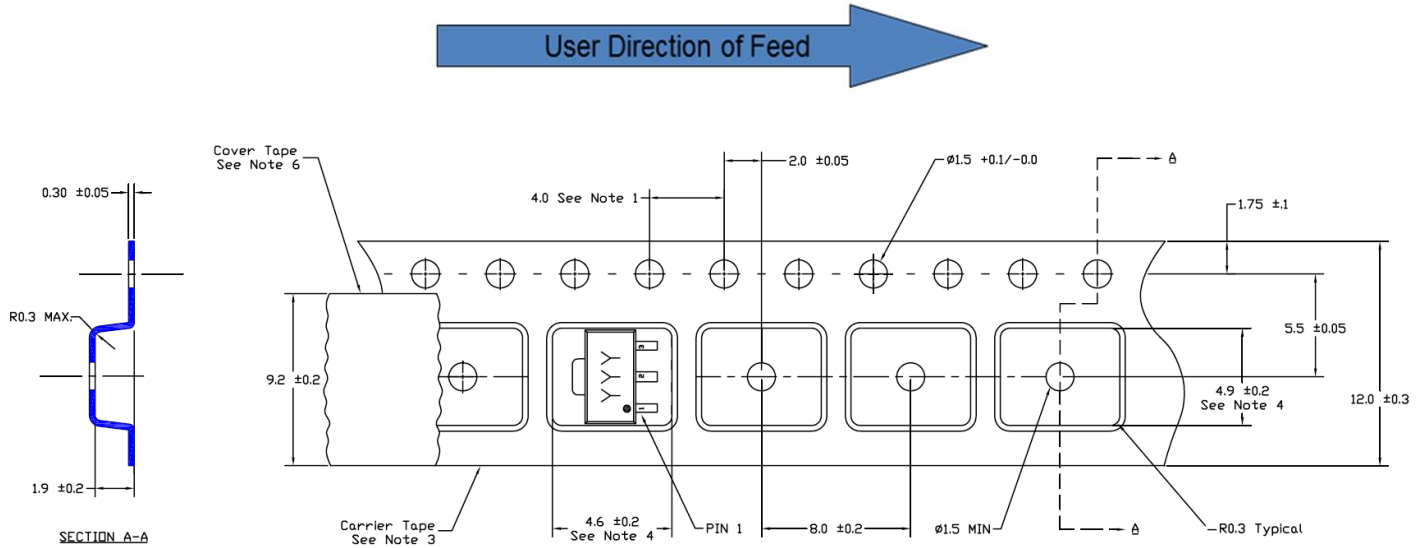

- 1. 10 sprocket hole pitch cumulative tolerance
- 2. Camber not to exceed 1mm in 100mm
- 3. Material: Black Conductive Polystyrene
- 4. Measured on a plane 0.3mm above the bottom of the pocket
- 5. Measured from a plane on the inside bottom of the pocket to the top surface of the carrier.
- 6. Material: Antistatic Polyester Film

Feature	Measure	Symbol	Size (in)	Size (mm)
Cavity	Length	A0	0.181	4.60
	Width	B0	0.193	4.90
	Depth	K0	0.075	1.90
	Pitch	P1	0.315	8.00
Centerline Distance	Cavity to Perforation - Length Direction	P2	0.079	2.00
	Cavity to Perforation - Width Direction	F	0.217	5.50
Cover Tape	Width	C	0.362	9.20
Carrier Tape	Width	W	0.472	12.0

Tape and Reel Information – Reel Dimensions

Standard T/R size = 1,000 pieces on a 7" reel.

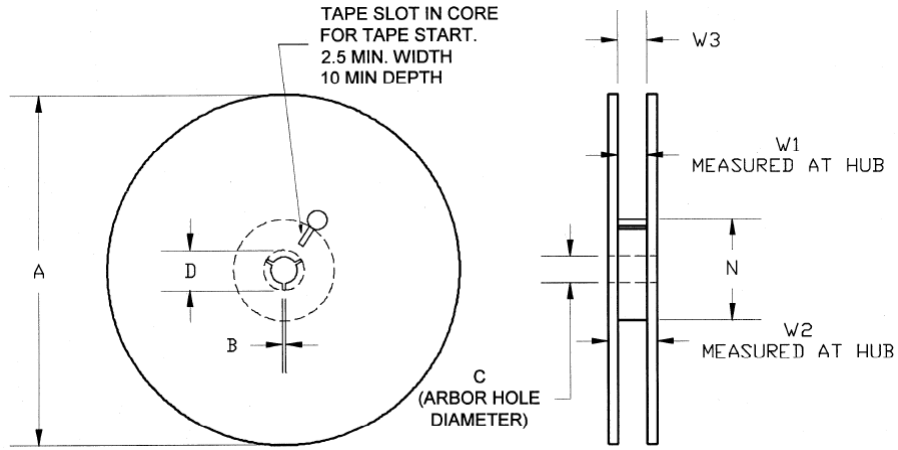

Feature	Measure	Symbol	Size (in)	Size (mm)
Flange	Diameter	A	6.969	177.0
	Thickness	W2	0.717	18.2
	Space Between Flange	W1	0.504	12.8
Hub	Outer Diameter	N	2.283	58.0
	Arbor Hole Diameter	C	0.512	13.0
	Key Slit Width	B	0.079	2.0
	Key Slit Diameter	D	0.787	20.0

Tape and Reel Information – Tape Length and Label Placement

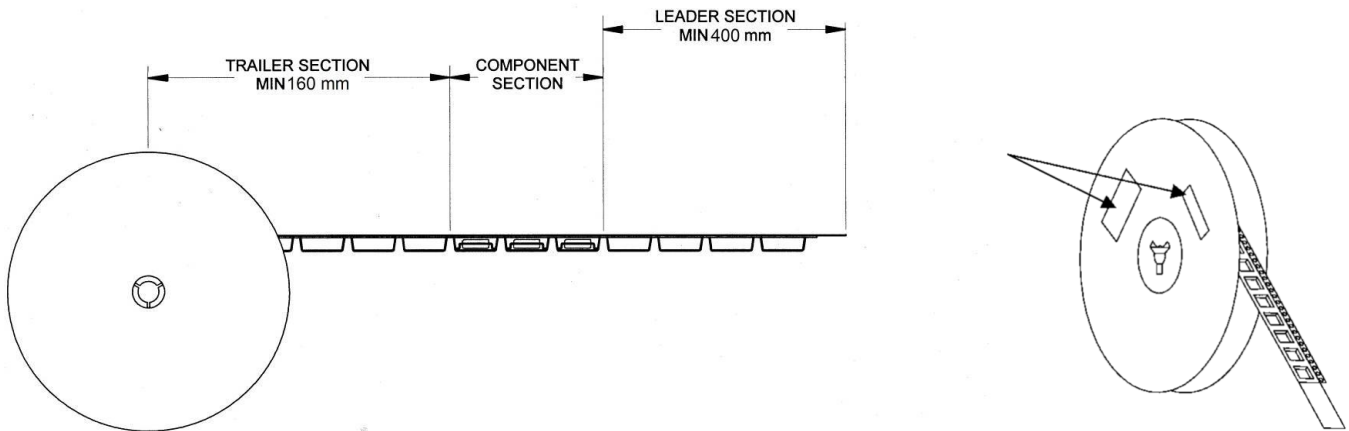

- Notes:
1. Empty part cavities at the trailing and leading ends are sealed with cover tape. See EIA 481-1-A.
 2. Labels are placed on the flange opposite the sprockets in the carrier tape.

Handling Precautions

Parameter	Rating	Standard
ESD – Human Body Model (HBM)	Class 1B	JEDEC JS-001-2010
MSL – Moisture Sensitivity Level	Level 3	IPC/JEDEC J-STD-020



Caution!
 ESD-Sensitive Device

Solderability

Compatible with both lead-free (260°C max. reflow temp.) and tin/lead (245°C max. reflow temp.) soldering processes. Solder profiles available upon request.

Contact plating: NiPdAu

RoHS Compliance

This part is compliant with 2011/65/EU RoHS directive (Restrictions on the Use of Certain Hazardous Substances in Electrical and Electronic Equipment) as amended by Directive 2015/863/EU.

This product also has the following attributes:

- Lead Free
- Halogen Free (Chlorine, Bromine)
- Antimony Free
- TBBP-A (C₁₅H₁₂Br₄O₂) Free
- PFOS Free
- SVHC Free



Contact Information

For the latest specifications, additional product information, worldwide sales and distribution locations:

Web: www.qorvo.com

Tel: 1-844-890-8163

Email: customer.support@qorvo.com

Important Notice

The information contained herein is believed to be reliable; however, Qorvo makes no warranties regarding the information contained herein and assumes no responsibility or liability whatsoever for the use of the information contained herein. All information contained herein is subject to change without notice. Customers should obtain and verify the latest relevant information before placing orders for Qorvo products. The information contained herein or any use of such information does not grant, explicitly or implicitly, to any party any patent rights, licenses, or any other intellectual property rights, whether with regard to such information itself or anything described by such information. **THIS INFORMATION DOES NOT CONSTITUTE A WARRANTY WITH RESPECT TO THE PRODUCTS DESCRIBED HEREIN, AND QORVO HEREBY DISCLAIMS ANY AND ALL WARRANTIES WITH RESPECT TO SUCH PRODUCTS WHETHER EXPRESS OR IMPLIED BY LAW, COURSE OF DEALING, COURSE OF PERFORMANCE, USAGE OF TRADE OR OTHERWISE, INCLUDING THE IMPLIED WARRANTIES OF MERCHANTABILITY AND FITNESS FOR A PARTICULAR PURPOSE.**

Without limiting the generality of the foregoing, Qorvo products are not warranted or authorized for use as critical components in medical, life-saving, or life-sustaining applications, or other applications where a failure would reasonably be expected to cause severe personal injury or death.

Copyright 2021 © Qorvo, Inc. | Qorvo is a registered trademark of Qorvo, Inc.